

## 99 DADU Filter Housing Replacement Procedure for P/N 336104-02

### 1.0 PURPOSE

1.1. The purpose of the instructions is to outline the process of replacing the obsoleted Filter Housing, P/N 336104-02,

### 2.0 SCOPE

2.1. This procedure applies to both the GranuFlo II (P/N 160000) and DADU 99 (P/N 160148) devices that have the obsoleted Filter Housing (P/N 336104-02) installed.

### 3.0 REFERENCES

Number	Name / Description
191291	FILTER ASSEMBLY W/ADAPTER

**NOTE:** REFERENCE DOCUMENTS ARE LISTED WITHOUT REVISION/EDITION LEVEL INDICATED AND ARE UNDERSTOOD TO REFER TO THE LATEST VERSION/EDITION OF THE DOCUMENT.

### 4.0 DEFINITIONS

Word/Abbreviation	Description
DADU	Dry Acid Dissolution Unit
WI	Work Instruction

### 5.0 TOOLS and SUPPLIES

Reference	Description
N/A	#2 Phillips Head Screw Driver
P/N 335006-09	1/2" TEFLON TAPE

## 99 DADU Filter Housing Replacement Procedure for P/N 336104-02

### 6.0 PROCEDURE

6.1.

Before starting the process of replacing the 99 DADU Filter Housing ensure the tank is empty.  
Disconnect the Power Cord from the Outlet.

No pictures, diagrams, figures or graphics associated with this step.

6.2.

Remove any item attached to transfer barb.  
Close the Transfer Valve by turning the T handle counter clockwise until it stops.  
Remove and discard Filter Housing Bowl by turning the counter clockwise off the Filter Cap.

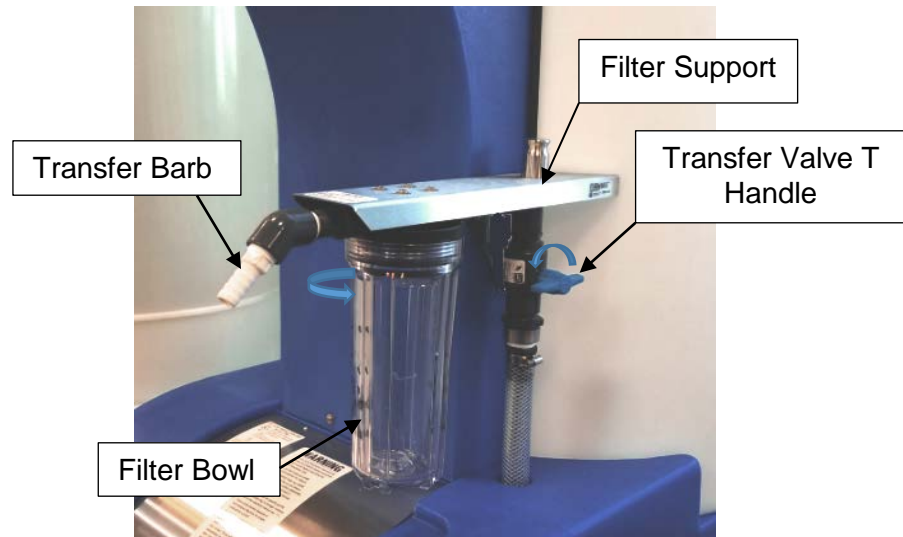

## 99 DADU Filter Housing Replacement Procedure for P/N 336104-02

6.3.

Using a #2 Screw Driver remove and discard the four screws and washers that attach the Filter Cap to the Filter Support.

After the removal of the four screws and washer the Filter Assembly will hanging.

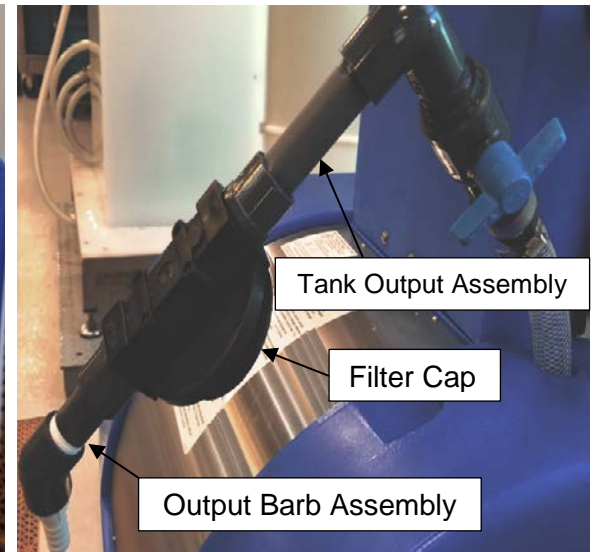

6.4.

Remove the Output Barb Assembly by twisting it counter clockwise until the assembly separates from the Filter Cap.

Then remove and discard the Filter Cap by turning the Filter Cap Counter Clockwise until the Filter Cap separates from the Tank Output Assembly.



## 99 DADU Filter Housing Replacement Procedure for P/N 336104-02

6.5.

Remove all residual PTFE tape from Output Barb Assembly and the Tank Output Assembly without damaging the threads.

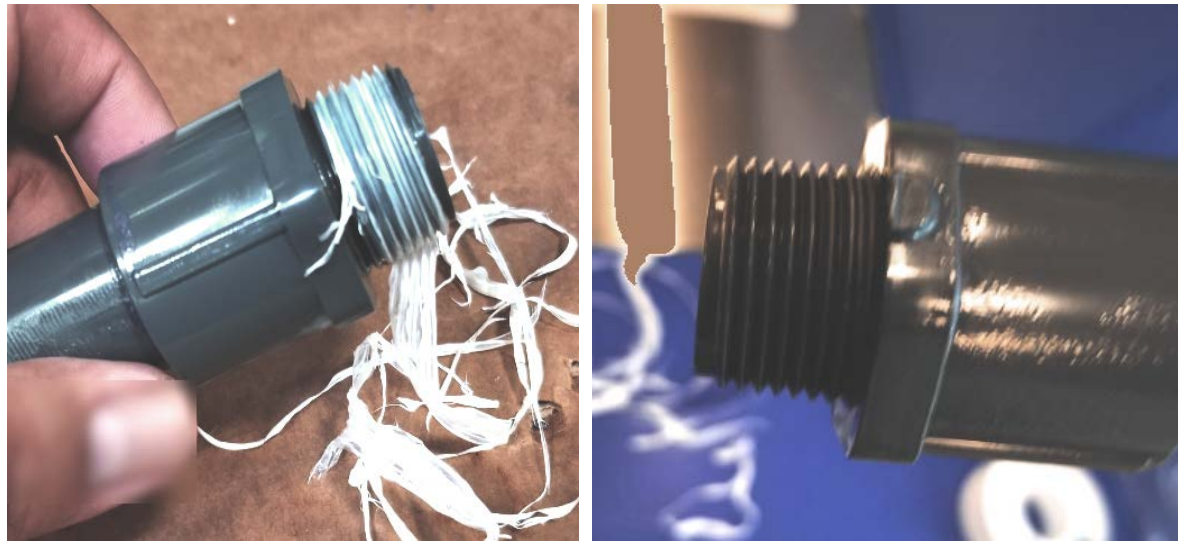

6.6.

Wrap 2-3 revolutions of **1/2" TEFLON TAPE**, P/N 335006-09, on the threaded surface of the Output Barb Assembly and the Tank Output Assembly at the Tank

**NOTE:**

1. Apply Teflon Tape keeping the edge of the tape parallel to the face of the fitting.
2. Align Teflon tape to the Nipple edge and wrap in the direction of the threads by starting with the first full thread and continuing over the entire thread length.
3. Tape should never extend beyond or overhang the first thread.



## 99 DADU Filter Housing Replacement Procedure for P/N 336104-02

6.7.

Remove the Filter Assembly w/ Adapter, P/N 191291, from the box.

Remove the Filter Cap w/ Adapter from the Filter Body.

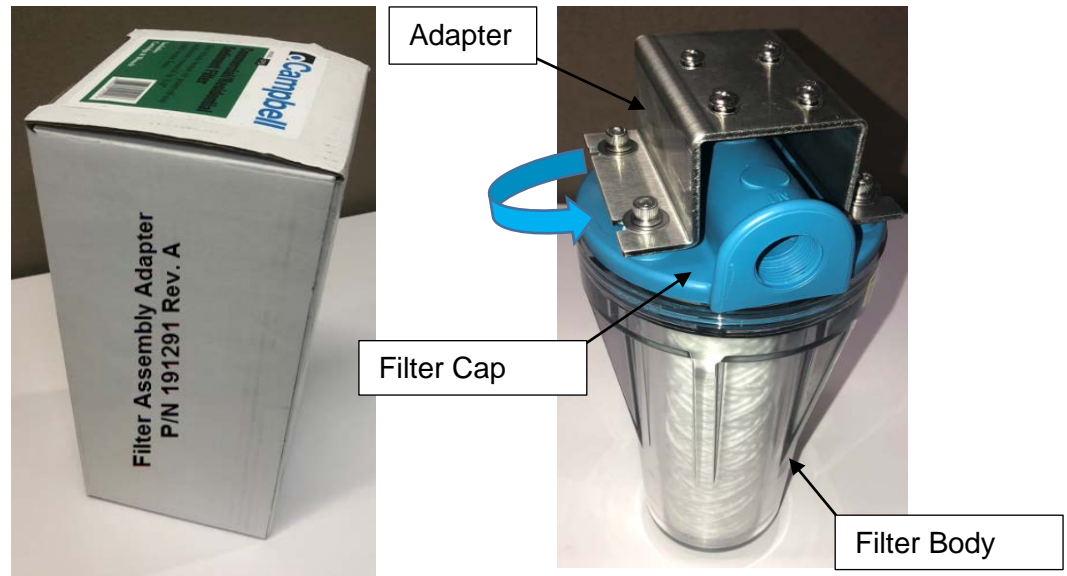

6.8.

The Filter Cap itself has OUT and IN molded on to the top. Install Output Barb Assembly by turning it Clockwise into the OUT side the Filter Cap w/ Adapter making sure that the Output Barb Assembly is oriented as illustrated in the adjacent picture.

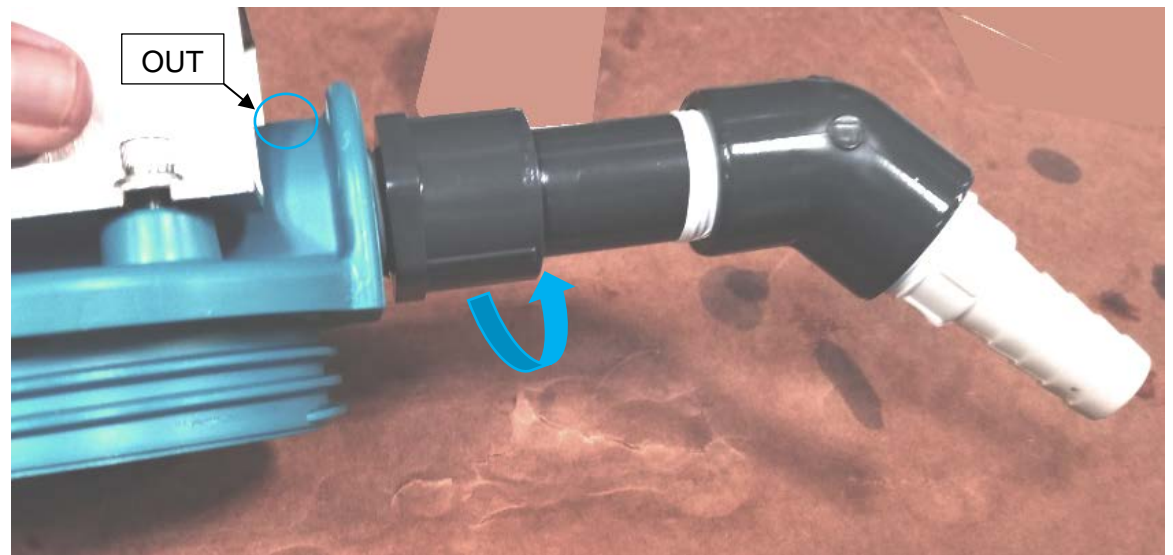

## 99 DADU Filter Housing Replacement Procedure for P/N 336104-02

6.9.

The Filter Cap itself has OUT and IN molded on to the top. Make sure install the IN side of the Filter Cap onto the Tank Output Assembly (See Step 6.3 for Tank Output Assembly location). With a slow Clockwise twist carefully install the Filter Cap w/ Adapter onto the Tank Output Assembly without cross threading the Filter Cap. Make sure to stop when the top of the Filter Cap w/ Adapter is perpendicular with the Filter Support.

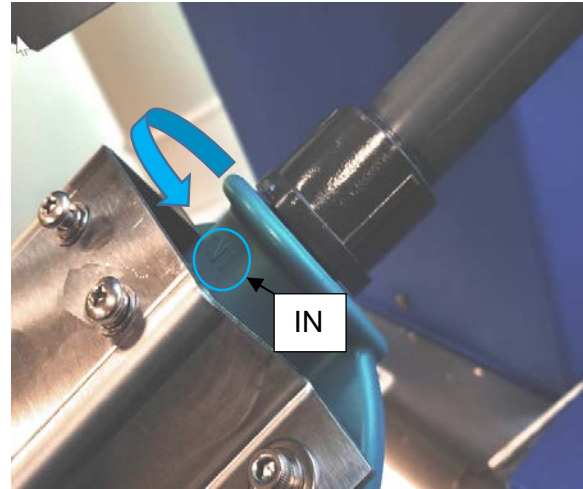



6.10.

Using a #2 Philips Screw Driver remove the screws and washers from the top of the Filter Cap w/ Adapter (keep the screws and washers readily available).

Line up the four screw holes of the top of Filter Cap w/ Adapter with the four holes on the underside Filter Support.

Once the screw holes of the Filter Cap w/ Adapter is lined up (see illustration), install one set of screw and washers (see illustration for installation order of screw and washers). Then loosely install the rest of the screws and washers.

**NOTE:**

-  SCREW, 10-32X1/2 PNHD PH SS, P/N 330918-07-01
-  WASHER, SPLIT LOCK, #10, SS, P/N 330606-04-01
-  WASHER, #10, LIGHT FLAT, P/N 330601-04-01

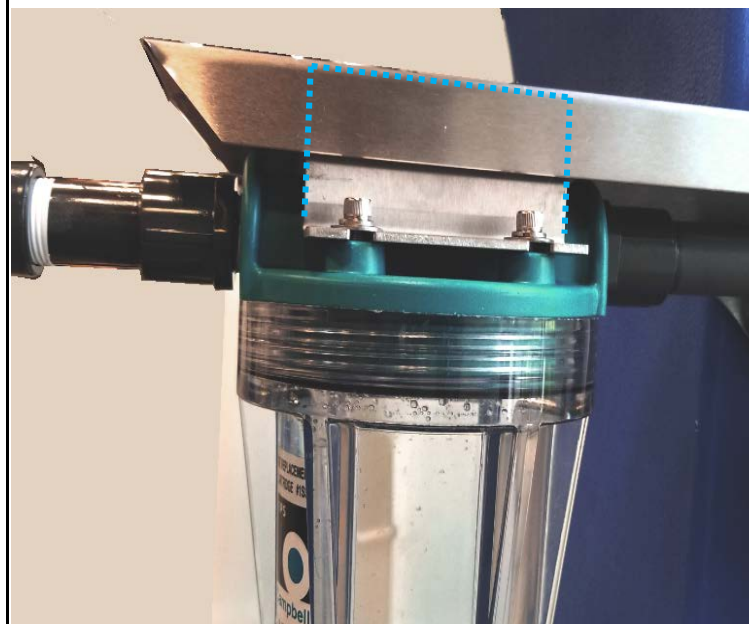

Screw holes of the Filter Cap w/Adapter aligned with the holes of the Filter Support.



## 99 DADU Filter Housing Replacement Procedure for P/N 336104-02

6.11.

Using a #2 Philips Screw Driver tighten down all four screws until the #10 Split Lock Washer is flattened.

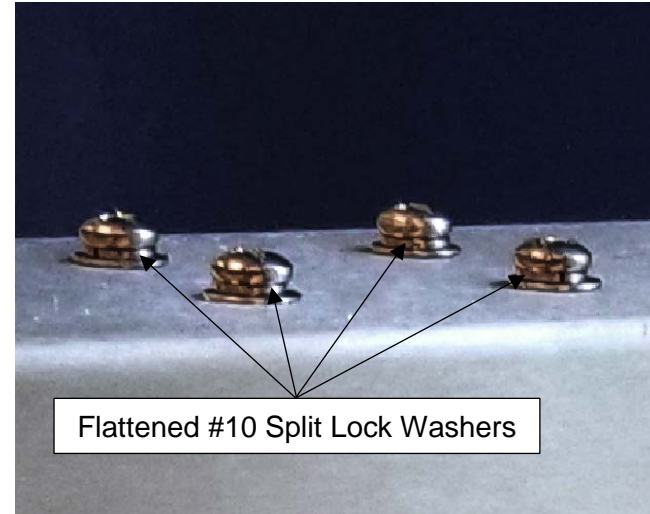

6.12.

Attach the Filter Bowl with filter onto the Filter Cap w/ Adapter.

**NOTE:** You may need to apply O-ring silicone grease to the filter bowl O-ring before installing. Filter not shown in image.

The replacement of the old filter housing is now complete. The completed replacement assembly should look as shown in the adjacent image.

You are now ready to move onto testing for leaks. See Section 7.



### 7.0 FILTER ASSEMBLY W/ADAPTER TEST PROCEDURE

7.1. Hook Transfer Hose with Transfer Nozzle to outlet barb of filter housing (See A and B of Figure 1). Tighten hose clamp.

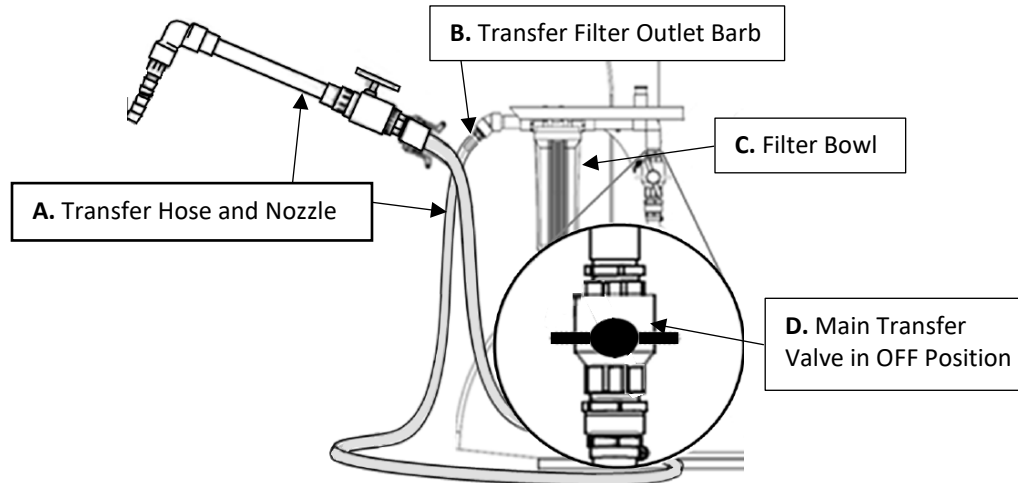

7.2. If not already installed, then attach filter bowl to filter housing (See C of Figure 1).

7.3. Ensure the power cord of the 99 DADU into power source.

7.4. Close the DADU-99's Main Transfer Valve (See D of Figure 1).

7.5. Place the Transfer Nozzle in the OFF Position and direct flow to Drain.

7.6. Turn machine ON:

7.6.1. Once machine is ON, the software will do the following:

- A. Turn the "Power ON" LED ON
- B. Illuminate the 4-Digit, 7-segment display in the ON condition displaying the numeric software version for 5 seconds.
- C. Illuminates LED indicating the last Operation the Device was in before it was turned OFF.
- D. If Device is illuminated LED for Cycle Complete Operation, then continue on with Step 8.

If the Cycle Complete Operation LED is not illuminated, then enter the STEP MODE by press the STEP MODE ON/OFF button until the Step Mode Indicator LED illuminates. The system will enter the STEP MODE and all operations will be suspended. Press STEP Button to step to the Cycle Complete Operation LED becomes illuminated, press Step ON/OFF Button and the selected Operation will be continued.



## 99 DADU Filter Housing Replacement Procedure for P/N 336104-02

- 7.7. Press Start Button on the Dissolution Cycle Side of the Display. Fill Light shall illuminate and water should be entering the tank. Once water fills to approximately 3 to 4 inches, Press the STEP MODE ON/OFF button until the STEP MODE LED is illuminated on the Display to Stop Fill Operation.

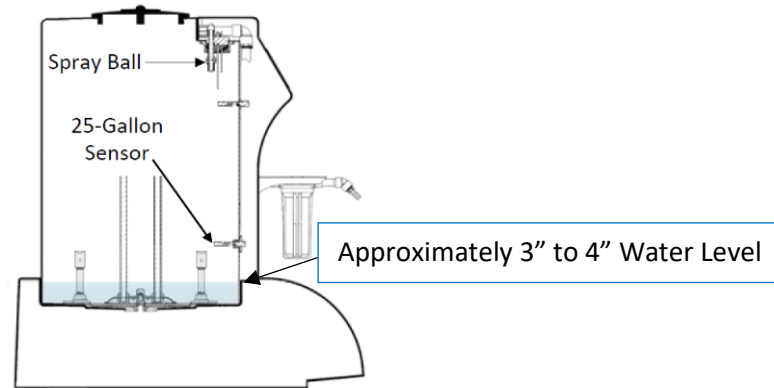

- 7.8. Using the STEP Button move from the Fill Operation to the Transfer Operation

- 7.8.1. Press the STEP button to step to the Transfer Operation. When the Transfer Operation LED becomes illuminated, press the STEP ON/OFF button until the LED Turns OFF and the Transfer Operation is continued.

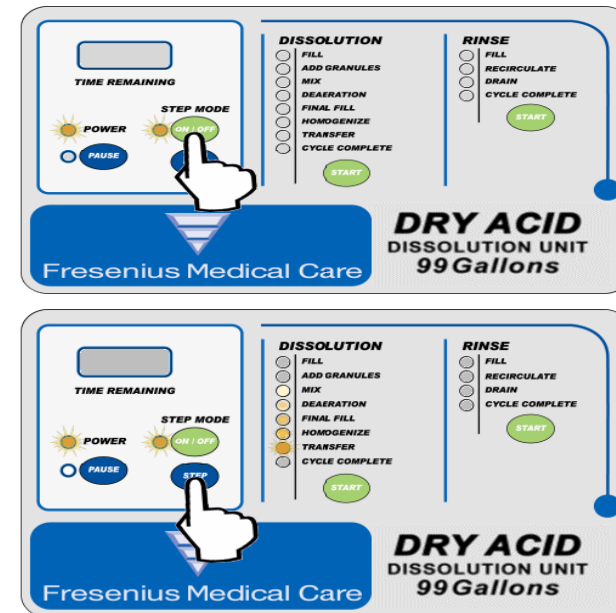

## 99 DADU Filter Housing Replacement Procedure for P/N 336104-02

- 7.9. Once the pump motor turns ON, turn ON Main Transfer Valve. Water will fill the Filter Bowl. If water begins to leak from A, B, and C (D if Fit Check 2) illustrated below, turn OFF Main Transfer Valve.

---

**NOTE: IF ANY LEAKS ARE FOUND, THEN THE LEAK MUST BE FIXED IMMEDIATELY. IN ADDITION, THIS TEST SHALL BE STARTED AGAIN FROM STEP 7.1**

---

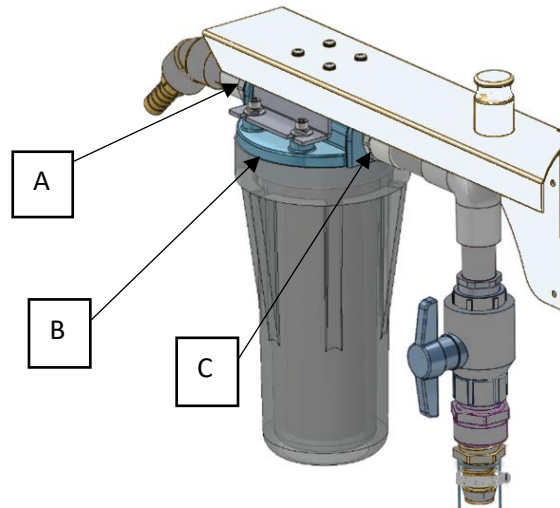

- 7.10. If there is no leaking at A, B, C, (illustrated above) or underneath the device, then leave the Device in the Transfer Operation for 10minutes ensuring there is no leak at A, B, C, or underneath the device throughout the 10 minutes. After successful completion of test, turn ON Transfer Nozzle and let the contents of the tank flow down the drain until device goes to Cycle Complete.