

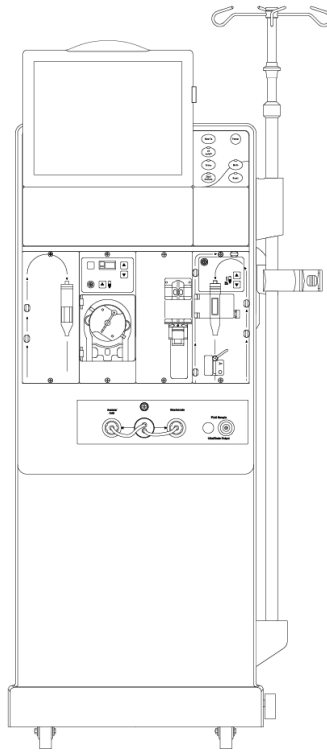

2008T Hemodialysis Machine

Operator's Manual



Caution: Federal (US) law restricts this device to sale only by or on the order of a physician.
Note: The most recent version of this manual can be accessed at fmcna.com/frtmanuals.

490122 Rev AA

2008T Hemodialysis Machine Operator's Manual

© 2008 - 2023 Fresenius USA, Inc. All Rights Reserved. Fresenius Medical Care, the triangle logo, 2008, 2008T BlueStar, Combiset, Twister, NaturaLyte, GranuFlo, bibag, Crit-Line, CLiC, DIAFIX, CDX, Citrasate, and DIASAFE are trademarks of Fresenius Medical Care Holdings, Inc., or its affiliated companies. All other trademarks are the property of their respective owners.

This document contains proprietary information of Fresenius Medical Care Renal Therapies Group, LLC and its affiliates ("Fresenius Medical Care"). The contents of this document may not be disclosed to third parties, copied, or duplicated in any form, in whole or in part, without the prior written permission of Fresenius Medical Care.

*The 2008T hemodialysis machine is manufactured by:
Fresenius USA, Inc.
4040 Nelson Avenue
Concord, CA 94520
(800) 227-2572*

Installation, maintenance, calibration and other technical information may be found on our website at fmcna.com.

Contact Fresenius Medical Care Technical Support for applicable Field Service Bulletins. The spare parts manual for the model 2008T and other information may be found on our website at fmcna.com

Caution: *Federal (US) law restricts this device to sale only by or on the order of a physician.*

Caution: *Frequency, duration, and parameters of treatment are to be determined by the prescribing physician.*

Note: *Not all features are available in all regions.*

Indications for Use:

2008T BlueStar Hemodialysis Machine: The 2008T BlueStar Hemodialysis Machine is indicated for acute and chronic dialysis therapy in a healthcare facility.

Additional therapy options for patients receiving hemodialysis include: Isolated Ultrafiltration, Sustained Low Efficiency Dialysis (SLED), and low volume hemodialysis (patients weighing ≥ 20 kg and ≤ 40 kg). This machine accommodates the use of both low flux and high flux dialyzers. The SLED therapy option is not to be used for patients weighing ≤ 40 kg. The 2008T BlueStar Hemodialysis Machine is not to be used for plasma replacement therapies, for patients weighing less than 20 kg, or for renal therapies using substitution fluid.

bibag System (Optional): The bibag system is used with three stream proportioning hemodialysis systems equipped with the bibag module such as the 2008T BlueStar Hemodialysis Machine and is intended for use in bicarbonate hemodialysis for acute and chronic renal failure. The bibag is intended for extracorporeal bicarbonate hemodialysis according to a physician's prescription.

Crit-Line Clip Monitor (CLiC) (Optional): The Crit-Line Clip Monitor is used with the 2008T BlueStar Hemodialysis Machine to non-invasively measure hematocrit, oxygen saturation and percent change in blood volume. The CLiC device measures hematocrit, percent change in blood volume and oxygen saturation in real time for application in the treatment of dialysis patients with the intended purpose of providing a more effective treatment for both the dialysis patient and the clinician. Based on the data that the monitor provides, the clinician/nurse, under physician direction, intervenes (i.e., increases or decreases the rate at which fluid is removed from the blood) in order to remove the maximum amount of fluid from the dialysis patient without the patient experiencing the common complications of dialysis which include nausea, cramping and vomiting.

Indications for Use:

2008T Hemodialysis Machine: The 2008T Hemodialysis Machine is indicated for acute and chronic dialysis therapy in a healthcare facility.

bibag System (Optional): The bibag system is used with three stream proportioning hemodialysis systems equipped with the bibag module such as the 2008T Hemodialysis Machine and is intended for use in bicarbonate hemodialysis for acute and chronic renal failure. The bibag is intended for extracorporeal bicarbonate hemodialysis according to a physician's prescription.

Crit-Line Clip Monitor (CLiC) (Optional): The Crit-Line Clip Monitor is used with the 2008T Hemodialysis Machine to non-invasively measure hematocrit, oxygen saturation and percent change in blood volume. The CLiC device measures hematocrit, percent change in blood volume and oxygen saturation in real time for application in the treatment of dialysis patients with the intended purpose of providing a more effective treatment for both the dialysis patient and the clinician. Based on the data that the monitor provides, the clinician/nurse, under physician direction, intervenes (i.e., increases or decreases the rate at which fluid is removed from the blood) in order to remove the maximum amount of fluid from the dialysis patient without the patient experiencing the common complications of dialysis which include nausea, cramping and vomiting.

Contents

About this manual.....	9
Requirements	10
Related Reading	10
Conventions	11
About Hemodialysis.....	14
General Warnings	16
Using a Central Venous Catheter.....	22
CHAPTER 1	
Overview.....	24
Function of the 2008T Hemodialysis Machine.....	24
Organization of the 2008T Hemodialysis Machine	24
The Control Panel	27
Control Panel Keypad.....	28
The Back Panel	36
PatientCard Reader (Optional).....	38
Modules	39
The Dialysate Path.....	45
IV Pole and Dialyzer Holder.....	49
Moving the Machine	50
CHAPTER 2	
Daily Preparation for Treatment	52
Starting Point	52
Preparing the Dialysis Delivery System	53
Manual Machine Setup	53
Auto Start Machine Setup.....	57
Preparing the Extracorporeal Blood Circuit.....	60
Connecting the Extracorporeal Blood Circuit.....	61
Priming the Blood Circuit.....	63
Testing the 2008T Hemodialysis Machine	72
Recirculation and Final Set-Up Procedure.....	75
CHAPTER 3	
Setting Treatment Parameters	77
Recommended Order for Screen-by-Screen Entry	78
New Treatment Key.....	79

Entering a Treatment Parameter	80
Dialysate Screen Settings.....	82
Home Screen Settings	93
Ultrafiltration	98
Isolated Ultrafiltration.....	101
Sodium Variation System	103
Heparin Screen Settings.....	107
Test & Options Screen Settings	112
Low Volume Dialysis	115
Blood Pressure Screen Settings	116
Using the Default Parameters Screen.....	119
Using the PatientCard	126
Starting Dialysis.....	135

CHAPTER 4

Monitoring the Treatment	137
Home Screen Monitoring.....	138
Trends Screen Monitoring	143
Kt/V & Access Flow Monitoring.....	146
Blood Temperature Monitor / Blood Volume Monitor Screen.....	154
Crit-Line Screen.....	157
Blood Pressure Screen Monitoring	164
During Treatment.....	165
Blood Recirculation Procedure	167
Power Failure during Dialysis	168
Completion of Dialysis	171
Returning Blood to the Patient (Standard Method)	172
Returning Blood to the Patient Using Assisted Reinfusion	173

CHAPTER 5

Disinfection and Maintenance	180
Cleaning and Disinfection.....	180
Cleaning the Exterior Surface.....	184
Rinse Program.....	188
Acid Clean Program.....	189
Heat Disinfection Program	190
Chemical/Rinse Program	191
Chemical/Dwell Program.....	193
Acid & Heat Disin (Disinfect) Program	194
Disinfect Log (Optional).....	197

CHAPTER 6

Alarms and Troubleshooting..... 198
 Operational Status..... 198
 Troubleshooting 202
 Replacing the DIASAFE *plus*_{US} Filter..... 277
 Replacing the 9-Volt Battery 278

APPENDIX A

Single Needle Dialysis (Optional) 280

APPENDIX B

Sustained Low Efficiency Dialysis (SLED) (Optional)..... 293
 Preparation 293
 Treatment Monitoring 295

APPENDIX C

The CDX System (Optional)..... 297
 Machine Connections..... 300
 Instructions for Clinic Information Systems Personnel 302
 CDX PC Specifications for the Intel N3060 Processor 305
 CDX PC Specifications for the Intel Atom D525 Processor 306
 CDX PC Specifications for the Intel Atom N270 Processor 307

APPENDIX D

Concentrate Types..... 310
 Estimated *bi*bag disposable run times (minutes)..... 313

APPENDIX E

Service Mode 314
 Treatment Options Screen..... 315
 Hardware Options Screen 320
 Default Settings Screen..... 326
 Auto Heat Disinfection (functional software version 2.69 or earlier) 330
 Enter Conc Screen: Selecting and Adding Concentrates 332
 UF Profile Screen: Creating Custom UF Profiles 338
 Module Options Screen..... 339
 Scheduler Screen (functional software version 2.72 or later)..... 341
 Auto Heat Disinfection (functional software version 2.72 or later)..... 343
 Auto Start (functional software version 2.74 or later) 345
 CDX Auto On (functional software version 2.72 or later)..... 347
 Auto On Features: General Considerations 348

PM Reminder	349
Diasafe Reminder	352
Cybersecurity	354
Testing the Dialysate.....	359
Equipment Storage and Maintenance	361
Machine Specifications.....	362
Essential Performance.....	373
Manufacturer’s EMC Declaration.....	375
Product Improvement Policy	379
Warranty	379
Patents	380
Glossary	381
Index	387

This page intentionally blank

About this manual...

The purpose of the *2008T Hemodialysis Machine Operator's Manual* is to instruct qualified patient-care staff in the function, operation, and maintenance of the 2008T hemodialysis machine. It is not intended as a guide for performing hemodialysis, a medical treatment that should only be performed under the supervision of a licensed physician.

This manual is organized to systematically guide a patient-care specialist through the set up, operation, and clean up of the 2008T hemodialysis machine in daily use. The book begins with an overview that introduces the operator to the major components and describes how they are organized on the machine. Next, the operator is guided through a daily set-up procedure. Once the machine has been prepared for daily use, a step-by-step guide to preparing the machine for a patient-specific treatment is provided. The operator is then provided a tour of the various treatment screen functions useful in monitoring the treatment, followed by instruction in terminating treatment and post-treatment clean up. Also included are sections on troubleshooting, maintenance, and treatment options.

The organization of the 2008T Hemodialysis Machine Operator's Manual is as follows:

- **Preface**
Identifies the intended audience, and describes how the manual is organized. It addresses various issues regarding the performance of hemodialysis and product liability, and provides information for contacting Fresenius USA, Inc.
- **Chapter 1—Overview**
Introduces the operator to the 2008T hemodialysis machine, its features, their functions, and how they are organized on the machine through pictures and descriptions.
- **Chapter 2—Daily Preparation for Treatment**
Provides instructions on the recommended methods of preparing the 2008T hemodialysis machine for daily, standard-dialysis operation.
- **Chapter 3—Setting Treatment Parameters**
Describes how to enter treatment data, and guides the operator through the relevant, treatment screens to enter patient-specific, treatment parameters in their recommended order. The chapter also covers the procedure for beginning dialysis treatment.
- **Chapter 4—Monitoring and the Completion of Treatment**
Guides the user through the screens used to monitor the dialysis treatment. It explains the features of each screen and describes the information displayed. The screens that provide a general overview of the treatment status are provided first, followed by the screens providing more in-depth data that are narrower in scope. It concludes with a description of the recommended, end-of-treatment procedure.
- **Chapter 5—Cleaning and Disinfection**
Recommendations for scheduled cleaning and disinfection, as well as maintenance procedures that should be performed by the operator are found here.
- **Chapter 6—Alarms and Troubleshooting**
This chapter is indexed by alarm messages to provide the operator a quick-reference guide for determining the cause and remedies for alarm situations.

About this manual...

- **Appendices**

In addition, this manual includes several appendices covering optional hemodialysis treatments, such as single-needle hemodialysis and Sustained Low Efficiency Dialysis (SLED), and provides information on the setup, customizing, storage and specifications of the 2008T hemodialysis machine.

- **Glossary**

A glossary of terms is included

- **Index**

An index to aid the operator in referencing information is included

Requirements

Operators of the 2008T hemodialysis machine must be trained to administer hemodialysis at the direction of a physician. In addition, the operator should be:



















- Knowledgeable of hemodialysis methodology and relevant physiology.
- Proficient in healthcare procedures regarding aseptic techniques.
- Thoroughly familiar with the contents of this manual.
- Fully trained and qualified to operate this machine, and able to distinguish between normal and abnormal operation.

Related Reading





The following documents contain information related to the 2008T hemodialysis machine:

- 2008T Hemodialysis Machine *bi*bag System Operator's Instructions (P/N 508213)
- 2008T Hemodialysis Machine with CLiC™ User's Guide (P/N 490206)
- 2008T Technician's Manual (P/N 490130)
- 2008T Calibration Procedures Manual (P/N 508032)
- 2008T Preventive Maintenance Procedures Manual (P/N 508033)
- 2008T Troubleshooting Guide (P/N 102297-01)
- 2008T Spare Parts Manual (P/N 490124)
- 2008T Field Service Bulletins may be obtained from the Fresenius Medical Care North America (FMCNA) website: fmcna.com or contact your clinic for more information.
- The test procedures by which the effectiveness of disinfection has been verified are available on request.

Conventions

Symbol	Description
 and 	Warning! A warning is a statement that identifies conditions or actions that could result in personal injury or loss of life. Warnings found in this manual outside of this section are designated with the warning symbol.
 and 	Shock Hazard: A shock hazard warning refers to a risk of a possibly severe electrical shock due to improper use or handling of the equipment.
	Corrosive Substance Hazard: A corrosive substance hazard warning refers to a risk of injury or machine damage due to improper use or handling of the equipment.
	Hot Surface, Fluid, or Vapors Hazard: A hot surface, fluid, or vapors hazard warning refers to risk of burn injury due to improper use or handling of the equipment.
	Tip Hazard: A tip hazard warning refers to a risk of injury or machine damage due to improper handling of the equipment.
	No Pushing: A no pushing warning refers to a risk of injury or machine damage due to leaning or pushing against the equipment.
	Caution: A caution is a statement that identifies conditions or actions that could result in damage to the machine.
	Mandatory Action: A command describing required action to maintain safety.
	Consult Accompanying Documents: This symbol is located on the 2008T hemodialysis machine. It means, refer to the 2008T Operator's Manual for additional information.
	Note: Notes are advisory comments or recommendations regarding practices or procedures.
	Do not reuse
 and 	ON: This symbol, at the top of the switches on the back of your machine, means the switch is in the ON position.
 and 	OFF: This symbol, at the bottom of the switches on the back of your machine, means the switch is in the OFF position.
	Degree of protection against electric shock: Type B
	Degree of protection against electric shock: Type CF Defibrillation-proof type CF Applied part – Blood Pressure Cuff only

About this manual...

Symbol	Description
	MR Unsafe: An item which poses unacceptable risks to the patient, medical staff or other persons within the MR (Magnetic Resonance) environment.
IPX1	Vertical drip-proof level of protection from liquid drips, leaks and spills
	Protective ground terminal
	Equipotentiality—this symbol may appear on older machines
	RF transmitter: Intentional Radio Frequency (RF) transmissions for wireless communications (see The CDX System, Appendix B)

Name	Description
Button	A button refers to specific fields <u>located in the treatment screens</u> that are used to set treatment parameters or perform an action when selected.
Control Panel	The control panel is located at the top third of the machine and contains the display screen and panel keys used in controlling the treatment.
Display Screen	The area located at the top of the control console that displays the treatment screens.
Key	A key is a pressure-sensitive, raised pad found on the control panel <u>outside of the treatment screen</u> that is used to enter a value, make a selection, or initiate an action or process.
Keyboard	The keyboard is located below the display screen. It flips down for data entry and can be closed again when not in use.
Screen	The graphic image displayed inside the display screen. There are eight main screens all of which are accessible from any of the other screens.
Subscreen	A smaller screen that can be opened from inside a particular main screen. Subscreens are not accessible from all main screens.
Touchpad	A flip-down panel on the right side of the control panel that reacts to fingertip pressure. The touchpad controls an on-screen cursor (arrow).
Touchscreen	Optional data input device that overlays the display screen. The touchscreen reacts to fingertip pressure.

About Hemodialysis...

Indications

Hemodialysis is prescribed by physicians for patients with acute or chronic renal failure, when conservative therapy is judged inadequate. Dialysis therapy may be intermittent or continuous.

Contraindications

There are no absolute contraindications to hemodialysis, but the passing of a patient's blood through an extracorporeal circuit may require anticoagulation to prevent blood clotting. In addition, the parameters of dialysis should be optimized to avoid discomfort to the patient. Many patients are taking medicinal therapy prescribed by their physicians. Due to the dialysis treatment, some of the medication may be removed from the patient's blood thereby lowering the therapeutic level in the blood. In other cases, medications may not be excreted as quickly as expected with patients with renal insufficiency and the level may be higher than expected. Therefore, the prescribing physician should determine the appropriate dosage of the medicine to obtain the desired medicinal response in the patient.

Some Side Effects of Hemodialysis

Dialysis therapy occasionally causes hypovolemia, hypervolemia, hypertension, hypotension and related symptoms, headache, nausea, cramping or other muscular discomfort in some patients. Hypothermia, hyperthermia, itching, anxiety, convulsions, seizure, and other neurologic symptoms associated with dialysis dementia may also be manifested by the patient. These symptoms are thought to occur if the patient's blood volume or electrolyte balance is not maintained within acceptable limits. Other, more serious, complications arising from dialysis, such as hemorrhage, air embolism, or hemolysis, can cause serious patient injury or death. The prescribing physician must understand that prescribing insufficient bicarbonate may contribute to metabolic acidosis; excessive bicarbonate may contribute to metabolic alkalosis. Both conditions are associated with poor patient outcomes, including increased risk of mortality. Proper control of all elements of dialysis may prevent or control these physiological reactions or complications.

Pyrogenic reactions may occur which can result in patient injury. Generally it is thought that these may be controlled by maintaining the dialysate solution within the chemical and bacteriologic limits (see Water Quality on page 363 of the "Machine Specifications" section for more information). Failure to use these standards for water can also lead to accumulated toxic effects. A regular program for disinfection and testing of the water treatment system, piping, inlet lines, filters, concentrate feed containers or system, and the dialysate delivery machine must be established and followed. This program will vary from facility to facility.

Infections or pyrogen reactions may also result from contamination of the extracorporeal circuit or inadequate procedures used to reuse dialyzers.

Allergic reactions to chemical disinfectants may occur if insufficient procedures are used to remove or maintain the residual disinfectant at acceptable levels. Chemical disinfectants are used for dialyzer disinfection, machine disinfection, or for disinfection of water treatment and distribution systems.

All blood connections must be made using aseptic technique.

All tubes and connections must be secured and closely monitored to prevent loss of blood or entry of air into the extracorporeal circuit or errors in the ultrafiltration control system. The patient may require blood transfusion or other medical intervention to prevent respiratory or cardiac disorders if these occur.

The patient's blood pressure and general physical status must be closely monitored during dialysis in order to initiate appropriate remedial measures or therapy. Of particular importance is the control of the patient's serum potassium level to prevent cardiac dysrhythmia and the patient's blood clotting time to prevent clotting disorders.

These instructions are for the 2008T hemodialysis machine. The machine must only be operated in accordance with these instructions. All operators of this machine must be thoroughly trained and have read this entire manual and any applicable appendices before using the machine. Improper care/use of this device may result in serious patient injury or death.

Blood Pressure Module Contraindications

The 2008T blood pressure monitoring subsystem is not intended for neonatal use. The following are generally accepted contraindications for using a timed automatic blood pressure instrument utilizing the oscillometric principle:

- Use of a heart lung machine
- Peripheral circulation problems
- Severe arrhythmia
- Ectopic beats
- Convulsions
- Spasms
- Tremors
- Tachycardia

Use of incorrectly sized blood pressure cuffs may result in inaccurate blood pressure readings.

This is a guideline only. Final determination of the suitability of any medical instrument for use with any patient, including pregnant or pre-eclamptic patients, is the responsibility of the treating physician.

General Warnings

This section contains general warnings statements regarding the use and maintenance of the 2008T hemodialysis machine. It is not a complete summary, and additional warning statements specific to pertinent topics can be found within this manual.

Water



Warning! Connect water inlet according to the specifications for the machine. For further information, see “Machine Specifications” on page 362. The correct ionic concentration and bacterial quality can generally be achieved in the dialysate only with treated water that meets water quality standards (see Water Quality and Dialysate Quality on page 363 of the “Machine Specifications” section for more information). Be sure that all specifications are satisfied. The water source must be monitored periodically to detect fluctuations in water composition and quality that could have an adverse effect on the patient or dialysate delivery machine. Particular attention must be taken for chemicals such as aluminum, chlorine, and chloramine, as these chemicals can cause complications in dialysis patients.



Warning! Comply with all local regulations in respect of separation of devices in the water supply in case of back siphonage; an air gap must be created between the machine’s drain line and its drain.

Concentrates



Warning! The specific acid and bicarbonate concentrates, including the sodium, bicarbonate, and electrolyte compositions, must be prescribed by a physician.



Warning! Many concentrate types are available for use in dialysate delivery machines. Concentrates contain various amounts of dextrose, potassium, calcium, sodium, chloride, magnesium, and other components. Most concentrates are designed as a two-part system of acid and bicarbonate solutions which are mixed in the machine with water. Even within the subgroup of bicarbonate type concentrates, there are at least four methods of compounding the solutions. Each of these methods requires special calibrations or setups. Certain methods are not supported. It is mandatory that the acid and bicarbonate types be matched to each other. Be sure to use compatible solutions, labeling, and setups. These setups include machine calibration, special adapters for certain concentrate types, correct setting of concentrate option, and labeling. Failure to use the properly matched solutions and machine calibrations may allow improper dialysate to be delivered to the patient, resulting in patient injury or death. Verify composition, conductivity, and pH after converting to a different type of concentrate.



Warning: Acid concentrate, bicarbonate concentrate, and water must be of the appropriate quality to ensure safety and performance of the final dialysate are met (see Water Quality, Dialysate Quality, and Concentrate Quality on page 363 of the “Machine Specifications” section for more information).



Warning: The dissolved *bibag* bicarbonate concentrate must be used within 24 hours of connecting to the dialysis machine. Do not refill the *bibag* container.



Warning! Connection to a central acid or bicarbonate feed system requires the installation of certain mechanical parts. Contact Fresenius USA, Inc. for more information.



Warning! Bicarbonate and acid concentrates intended for other dialysate delivery machines will deliver safe dialysate solution only if the machine is set up for them. The selection of other dialysate concentrate types must be done by a qualified, authorized person. The 2008T hemodialysis machine can be set up for various concentrate types. Use Table 40 in Appendix D to ensure that you have compatible concentrates and configurations.



Warning! Acid concentrate products are used as one component in mixing dialysate bath. These acid products contain chemical compounds that, after mixing, yield acetate (and citrate in certain products) in the dialysate. (Please refer to the acid concentrate product labeling for specific acetate/citrate amounts.) After diffusion across the dialyzer membrane, acetate (and citrate when present) is metabolized by the liver to serum bicarbonate and adds to the serum bicarbonate that separately results from the diffusion of dialysate bicarbonate across the dialyzer membrane. During dialysis, the dynamic of diffusion and concentration gradients prevent serum bicarbonate concentration from exceeding the dialysate bicarbonate concentration. The bicarbonate concentration of the dialysate is the “bicarbonate” setting on the dialysis machine, and is the bicarbonate dose prescribed by the physician. On the 2008 series hemodialysis machines, the bicarbonate dose may be set in a range between 20 and 40 milliequivalents per liter, but may be set in different ranges in other machines.

When the dialysis session terminates, acetate (and citrate when present) that has not yet metabolized may remain in the blood and will be converted to serum bicarbonate after diffusion ceases, without possibility of diffusion out of the blood. The post dialysis metabolism of acetate (and citrate when present) could thus briefly increase serum bicarbonate concentration above the prescribed bicarbonate concentration of the dialysate. Physicians should consider this possibility in prescribing bicarbonate dose.

Prescription of insufficient bicarbonate may contribute to metabolic acidosis; excessive bicarbonate may contribute to metabolic alkalosis. Both conditions are associated with poor patient outcomes, including increased mortality risk.



Warning! Incorrect composition will result if the acid concentrate nozzle is not connected to the appropriate acid concentrate or the bicarbonate concentrate nozzle is not connected to the appropriate bicarbonate solution. The acid and bicarbonate concentrates must match those selected in the “Dialysate” screen. Patient injury or death may occur if incorrect dialysate solution is used. Fresenius USA, Inc. recommends the operator use the concentrate containers provided with the machine. These containers, being of different size and shape, help to reduce the chances of mismatching the acid and bicarbonate concentrates.



Warning! Always verify the conductivity and approximate pH of the dialysate through independent means before beginning treatment. Independent means could be by using an external conductivity meter, pH meter, pH paper or by using the machine’s independent conductivity test. Verify also when changing concentrates during treatment and when switching from the bi^{bag} system to liquid bicarbonate*. The wrong concentrate composition, conductivity or pH may cause serious injury or death.

*Note: The machine’s conductivity and temperature readings should stabilize within ten minutes after changing concentrates. If alternative liquid bicarbonate concentrate sources are used (jugs or central delivery) the end user must ensure the bicarbonate is of appropriate quality and is prepared per manufacturer’s instructions.



Warning! The machine must be labeled to indicate the type of concentrate for which it is configured. Check the composition (i.e., Na, Cl, K, Ca, Mg, HCO₃) and pH of the dialysate solution after the machine is installed or after the machine is modified for different concentrate types. Verify the conductivity and approximate pH of the dialysate solution through independent means before initiating dialysis. Independent means could be by using an external conductivity meter, pH meter, pH paper or by using the machine's independent conductivity test. Improper conductivity or pH could result in patient injury or death.

Machine



Warning! Failure to install, operate, and maintain this equipment according to the manufacturer's instructions may cause patient injury or death. If this equipment is modified, appropriate inspection and testing must be conducted to ensure continued safe use of the equipment. Substitution of a component different from that supplied may result in measurement errors.



Warning! Use of this equipment adjacent to or stacked with other equipment should be avoided because it could result in improper operation. If such use is necessary, this equipment and the other equipment should be observed to verify that they are operating normally.



Warning! Use of accessories, transducers and cables other than those specified or provided by the manufacturer of this equipment could result in increased electromagnetic emissions or decreased electromagnetic immunity of this equipment and result in improper operation.



Warning! Proper functioning of the machine must be verified prior to initiating treatment. Unidentified malfunctions or alarm failure could potentially expose a patient to a serious health risk. Alarm limits for the arterial pressure monitor, venous pressure monitor, and transmembrane pressure (TMP) monitor are automatically set and delayed for pressure stabilization. Alarm limits for temperature and conductivity are calculated for the dialysate composition and may be somewhat adjusted by the operator. These must be maintained within safe physiological limits as specified by the prescribing physician.



Warning! Never perform maintenance when a patient is connected to the machine. If possible, remove the machine from the treatment area when it is being serviced. Label the machine to ensure it is not accidentally returned to clinical use before the service work is completed. Disinfect the machine and test the dialysate for acceptable conductivity and pH values before returning the machine to clinical use. Always test the machine when maintenance is completed.



Warning! To avoid damaging the equipment or personal injury, internal adjustments to the blood pressure module should only be made by a qualified technician.



Warning! The electrical source must be single phase, three-conductor type provided with a hospital grade receptacle with protective earth and a ground fault interrupter at 120 volts, 60 Hz. The proper polarity and ground integrity must be initially checked and maintained. Failure to do so may result in electrical shock or burn to the operator or patient. The machine must be plugged directly into the electrical outlet; extension cords and power strips are prohibited.



Warning! Shock hazard. Do not remove covers. Refer servicing to qualified personnel. Replace fuses only with the same type and rating.



Warning! Do not install the 9-Volt battery backwards in the machine, as it will damage the “No Power” alarm.



Warning! Do not use devices emitting strong electromagnetic radiation such as portable phones, radio equipment (walkie-talkies, etc.), radio transmitters, and like equipment near your machine. Improper operation may result.

Cellular phones and WiFi connected devices may be conditionally allowed. However, if any interference is noted, such as false pressure readings that disappear when the external signal is removed, it is recommended to move the cellular phone at least ten feet away from the 2008T hemodialysis machine when making or receiving phone calls. If a WiFi-connected device (e.g. laptop computers, tablet devices, smartphones) is found to cause interference, it is recommended to use that device at least four feet away from the 2008T hemodialysis machine.

Portable RF (radio frequency) communications equipment (including peripherals such as antenna cables and external antennas) should be used no closer than 30 cm (12 inches) to any part of the hemodialysis machine, including cables specified by the manufacturer. Otherwise, degradation of the performance of this equipment could result.

For exact separation distance recommendation, please refer to the Manufacturer’s EMC Declaration statement on page 375.



Warning! An overview of the cybersecurity controls implemented within the 2008T machine is available upon request in the “Manufacturer Disclosure Statement for Medical Device Security (MDS2)” with or without CDX. Fresenius Medical Care continuously monitors security threats, vulnerabilities, and security incidents, including vulnerabilities identified by the operating system and third-party software vendors, customers, and security researchers. The Fresenius Medical Care PSIRT (Product Security Incident Response Team) then will evaluate potential security incidents and vulnerabilities and develop remediations as necessary.

Additionally, Fresenius Medical Care advises the following industry best practices to promote a defense-in-depth strategy for secure operation of the 2008T machine:

- Conduct a comprehensive security risk assessment on the medical network in accordance with operational security best practices such as ISO 27002
- Ensure local procedures include inspection of the 2008T machine for physical tampering prior to each use
- Ensure that all portable media used for data exchange with the medical network (such as CDs, USB drives, etc.) are scanned before use
- Implement physical controls that ensure no unauthorized persons would have physical access to the 2008T machine

For systems with network connectivity:

- Ensure all network connected systems are kept up to date with relevant security patches
 - Minimize remote access to the network and implement multi-factor authentication
 - Minimize network exposure for the 2008T machine, and ensure that it is not accessible from the Internet
 - Locate the 2008T machine behind firewalls, in dedicated medical networks isolated from all other IT networks
 - Ensure state-of-the-art data encryption is implemented for all Wi-Fi communications
 - Implement application firewalls capable of deep packet inspection to help protect
-

against zero-day vulnerabilities and the latest exploits

- Ensure that all programming software and equipment (service laptops, etc.) are kept up to date with the latest software updates and patches, only connected to a network for their intended purpose, and kept in physically protected (locked) locations when not in use.

Failure to ensure a secure operating environment for the 2008T machine may put prescription data sent to the machine at risk.



Warning! Transducer protectors should be used between pressure ports and each pressure monitor line of the extracorporeal system to prevent the internal transducer protectors from getting wet. Wet transducer protectors must be replaced, as they will cause inaccurate pressure readings. If the external transducer protector and the internal transducer protector become contaminated with blood, the transducer protectors **must** be replaced and the transducer, pressure ports, internal tubing and valve must be disinfected or replaced to prevent cross-contamination between patients.



Warning! A new, sterile transducer protector should be placed on all the air connections from the drip chambers to the machine pressure monitor ports. This will prevent patient cross-contamination and contamination of the machine and filters air that enters the chambers through the monitor lines. If the transducer protector should get wet and air is not able to pass, replace the transducer protector and clear the monitor line.



Warning! The machine is compatible with a number of venous lines. The Level Detector module must be calibrated for the model venous line being used. In addition, verify that the venous line clamp is capable of fully occluding the model of bloodline that your facility uses. Improper functioning of the level detector may be caused by a clot of blood.



Warning! Possible Explosion Hazard if used in the presence of flammable anesthetics.



Warning! Check all bloodlines for leaks after the treatment has started. Keep access sites uncovered and monitored. Improper bloodline connections or needle dislodgements can result in excessive blood loss, serious injury, and death. Machine alarms may not occur in every blood loss situation.



Warning! Air may enter into the extracorporeal circuit at connection points downstream of the air detector, if pressures are negative. This can occur in cases such as single needle applications or central venous catheter applications.



Warning! The dialysate path is a closed fluidics system. Discontinue use immediately if a fluid leak is detected. Do not attempt to administer or continue dialysis treatment with a machine which has a fluid leak, this could result in excessive fluid removal from the patient leading to serious injury or death. System leaks may also pose a slip-and-fall hazard. Clean up spills immediately.



Warning! Replace a leaking *bi*bag disposable immediately. Spills can cause damage to carpeting and other surfaces. To contain such spills, the machine should be on a spill-tolerant surface. Spills can cause slips and falls; clean up spills immediately.



Warning! When using the *bi*bag system, the acid and bicarbonate pressures must not exceed 10 psi when using a Central Delivery System. It may be necessary to use pressure regulators in order to reach proper conductivity. When not using the *bi*bag system, the maximum supplied pressure is 2 psi.



Warning! High dose hydroxocobalamin (or any form of Vitamin B-12) causes discoloration of the spent dialysate. This discoloration may cause a false blood leak alarm, stopping the blood pump and preventing treatment unless the operator performs an override of the alarm. The blood leak alarm can be reset and overridden for up to three minutes repeatedly by following the blood leak alarm troubleshooting instructions in the operator's manual in cases where a blood leak test is negative for blood in the dialysate.

Discontinuation of the hemodialysis treatment could result in persistence or worsening of acidosis, hyperkalemia, and volume overload which can lead to serious injury or death.



Caution: Only the bags manufactured by Fresenius Medical Care may be used in the *bibag* connector.



Caution: System leaks may occur. Unattended operation of the machine (for example, during disinfection at night) may result in flooding and can cause property damage. Clean up spills immediately.



Caution: Be careful not to tip the machine when rolling over uneven surfaces. Push the machine from the middle when moving it.



Caution: Do not squeeze the blood pressure cuff when deflating it. Squeezing the blood pressure cuff may damage the machine's internal blood pressure module.



Note: The DIASAFE[®] *plus*_{US} filter is required when the *bibag* system is in use.



Note: A smoke detector should be properly installed in the room used for dialysis. Follow the manufacturer's instructions. The alarm should be tested according to the manufacturer's instructions. Replace the battery as specified.



Note: You must follow all environmental regulations regarding waste disposal and eventual machine disposal. Contact your clinic for more information. Prior to the disposal of your machine, any possible risk of infection from blood borne pathogens must also be eliminated by appropriate disinfection.



Note: The temperature of the bloodline and the durometer of the tubing affect the ability of the bloodline/blood pump system to prime during setup. Cold tubing may not prime as readily as warm tubing.

Fresenius Medical Care manufactures bloodlines for use with the model 2008T hemodialysis machine. The performance of bloodlines not manufactured by Fresenius Medical Care cannot be guaranteed by Fresenius Medical Care and are therefore the responsibility of the prescribing physician.



Note: The following materials come into contact with purified water, dialysate, or dialysate concentrate:

Dyflor (PVDF)	Polypropylene (PP)
Ethylene-propylene terpolymer (EPDM)	Polypropylene 20% glass fiber (PP-GF20)
Foraflon (PVDF)	Radel 10 & 20% glass fiber (PES)
Glass	Stainless steel (types 300 & 316)
Lupolen (PE)	Silicone (Si)
Makrolon (PC)	Teflon (PTFE)
Noryl (PPE & PS)	Thermocomp (PES)
Polyethersulfone (PES)	Titanium – TiAl 4 V6
Polyphenylene oxide (PPO)	Ultem (PEI)
Polyphenylene oxide 20% glass fiber (PPO-GF20)	Ultradur+ (PBT)
Polyphenylsulfone (PPSU)	Victrex (PEEK)
	Vinyl chloride polymer (PVC)

Using a Central Venous Catheter

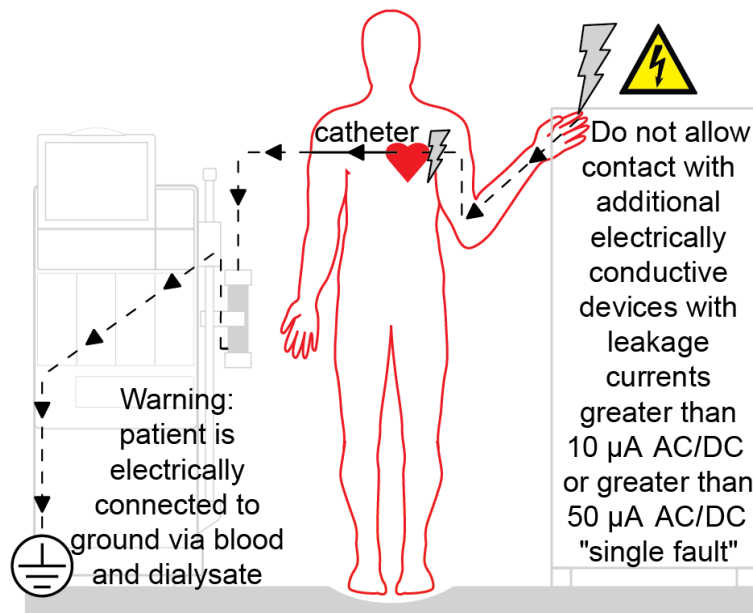

Shock Hazard: Ensure that no conductive electrical devices connected to or near the patient, including water and concentrate central delivery systems connected to the machine, have leakage currents above the maximum CF applied parts limit of 10 μA AC/DC and 50 μA AC/DC in a single fault condition. Failure to follow these precautions may result in serious injury or death.

Maintenance

Assembly, installation, adjustment, or repair is to be performed only by persons authorized by the facility medical director or by Fresenius USA, Inc.

Questions?

For further information regarding the operation, repair, parts, or maintenance of the 2008T hemodialysis machine, please contact:

Fresenius USA, Inc.

(800) 227-2572

Attention: Service Department
4040 Nelson Avenue
Concord, CA 94520
fmcna.com

Additionally, updates to this operator's manual are available for download here:
fmcna.com/product-support-documentation/

Overview

The 2008T hemodialysis machine is designed to perform hemodialysis in hospitals and dialysis clinics. It can be used for patients suffering chronic or acute renal failure.

Function of the 2008T Hemodialysis Machine

The 2008T hemodialysis machine is designed to provide hemodialysis treatment by controlling and monitoring both the dialysate and extracorporeal blood circuits.

In the extracorporeal blood circuit, the blood is continuously circulated from the patient through a dialyzer, where toxins are filtered out through a semi-permeable membrane, before being returned to the patient. During this process, the extracorporeal blood circuit is monitored for venous and arterial blood pressures, and for the presence of air and blood. The 2008T hemodialysis machine can also administer heparin evenly throughout the treatment.

In the dialysate circuit, the dialysate concentrates are mixed with purified water, heated, degassed, and delivered to the dialyzer. Balancing chambers ensure that the incoming flow of the dialysate is volumetrically equal to the outgoing flow in order to control ultrafiltration from the patient.

Organization of the 2008T Hemodialysis Machine

The 2008T hemodialysis machine is designed for functional efficiency. The back of the machine houses the utility connections such as water source, drain, and electrical connections. By mounting them to the back, the water lines and power cord remain out of the way during treatment.

The front of the machine contains all of the controls the operator needs access to during hemodialysis. It can be broken down into three main sections. The top section contains the control panel and houses the computer that runs the treatment program. The middle section contains the modules used for the safe transmission of the blood to and from the dialyzer. Dialysate is the primary concern of the bottom section of the 2008T hemodialysis machine. Here the concentrates used to make up the dialysate are mixed and pumped to the dialyzer.

The following pages contain front and rear views of the 2008T hemodialysis machine and a brief description of the machine's features. You should familiarize yourself with the location and purpose of these features.

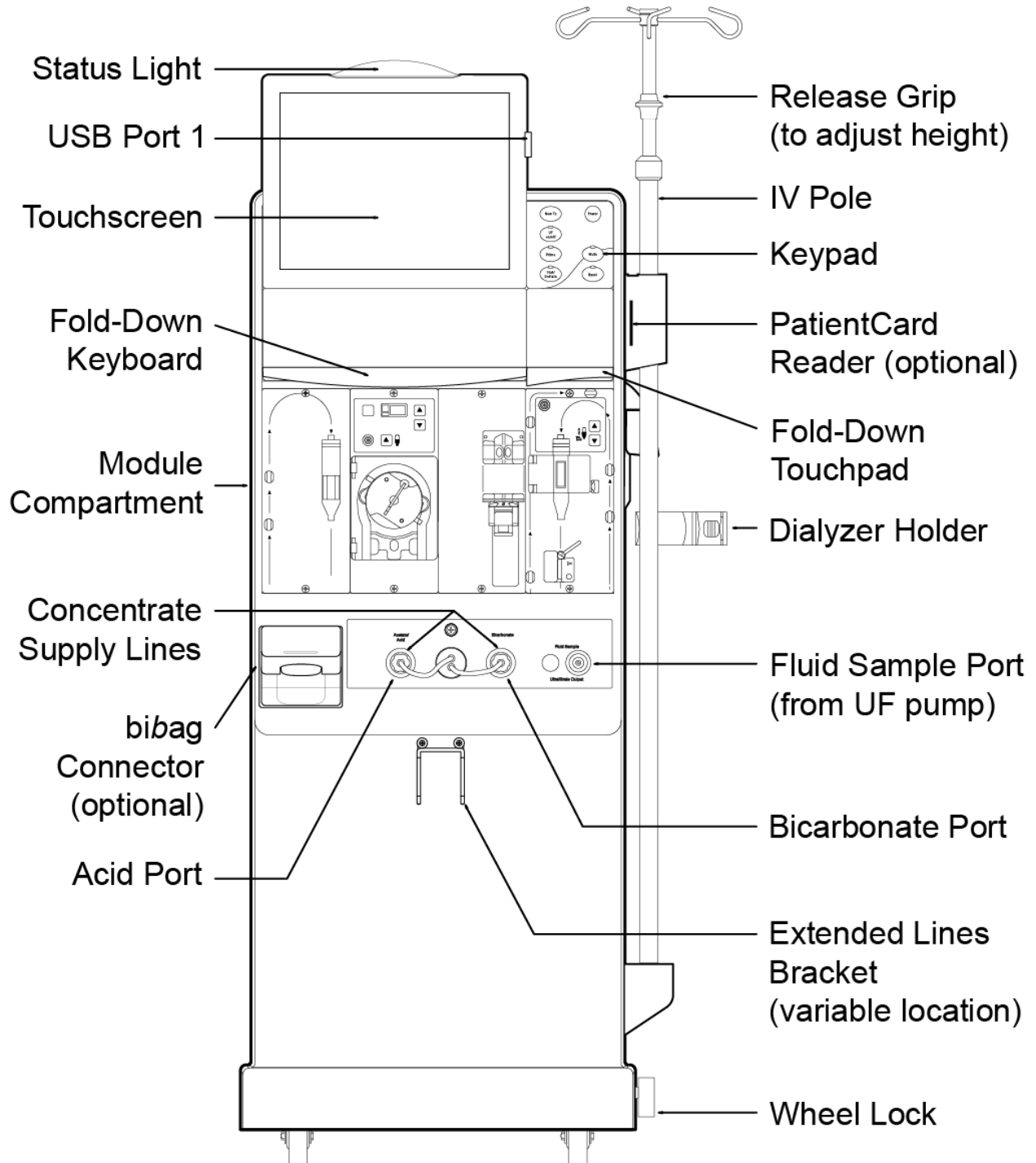

Figure 1 – 2008T Hemodialysis Machine—Front View

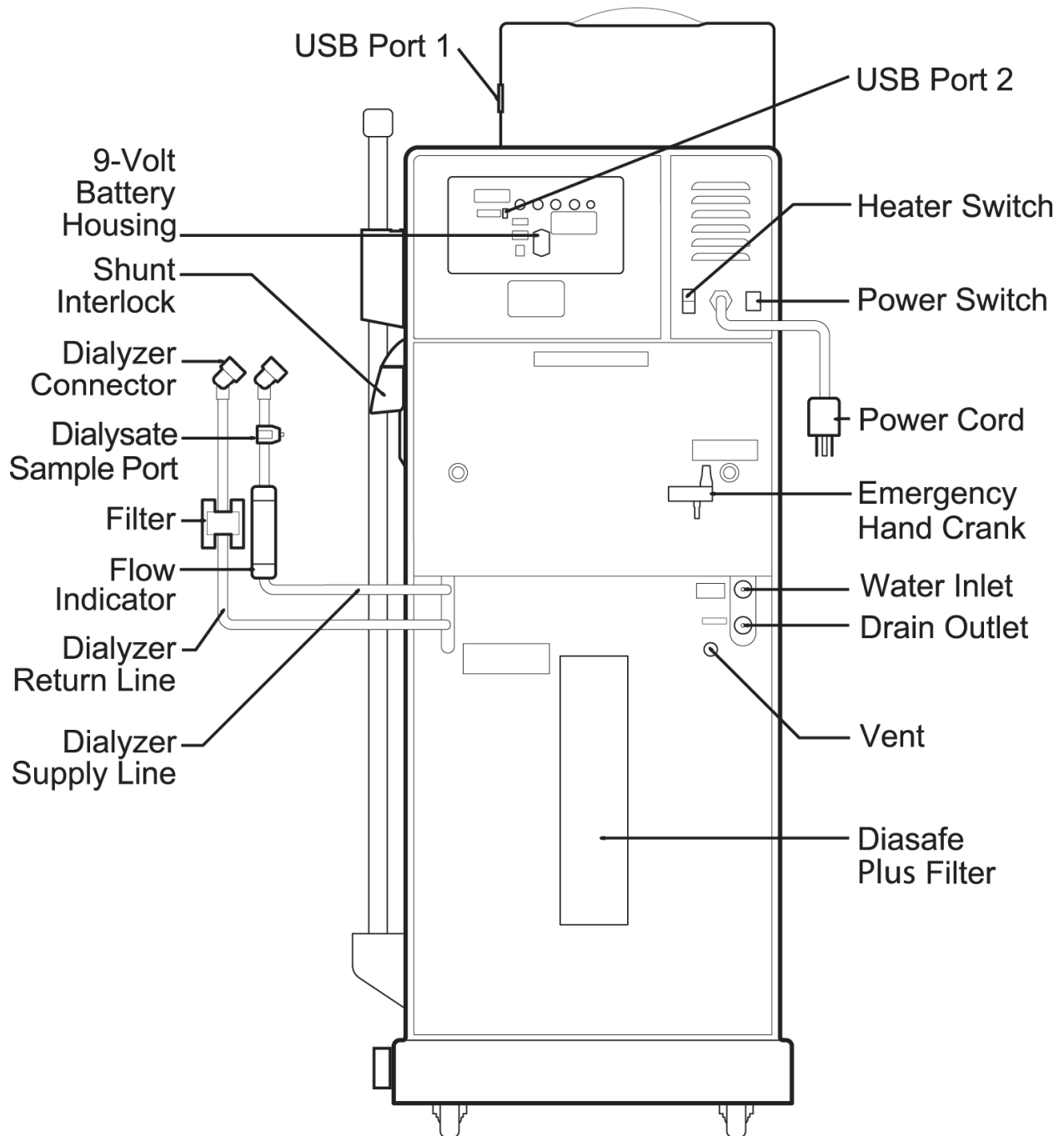

Figure 2 – 2008T Hemodialysis Machine—Rear View

The Control Panel

The control panel (see Figure 3) is located at the top, front of the 208T hemodialysis machine and contains keys that allow the user to control the operation of the 208T hemodialysis machine. Located at the top of the control panel is a display screen that can show a variety of treatment screens which the operator uses to set treatment parameters and monitor the treatment.

The treatment display screen provides a means of setting the treatment parameters and monitoring the treatment and patient status during dialysis. The operator can access treatment screens, select the Tx Clock, and set treatment parameters by selecting specific, identified sites (buttons) on the screen by using the touchpad cursor or by touching them directly with the touchscreen. Changes to settings and parameters selected on the screen must then be confirmed by pressing the **CONFIRM** key on the control panel.

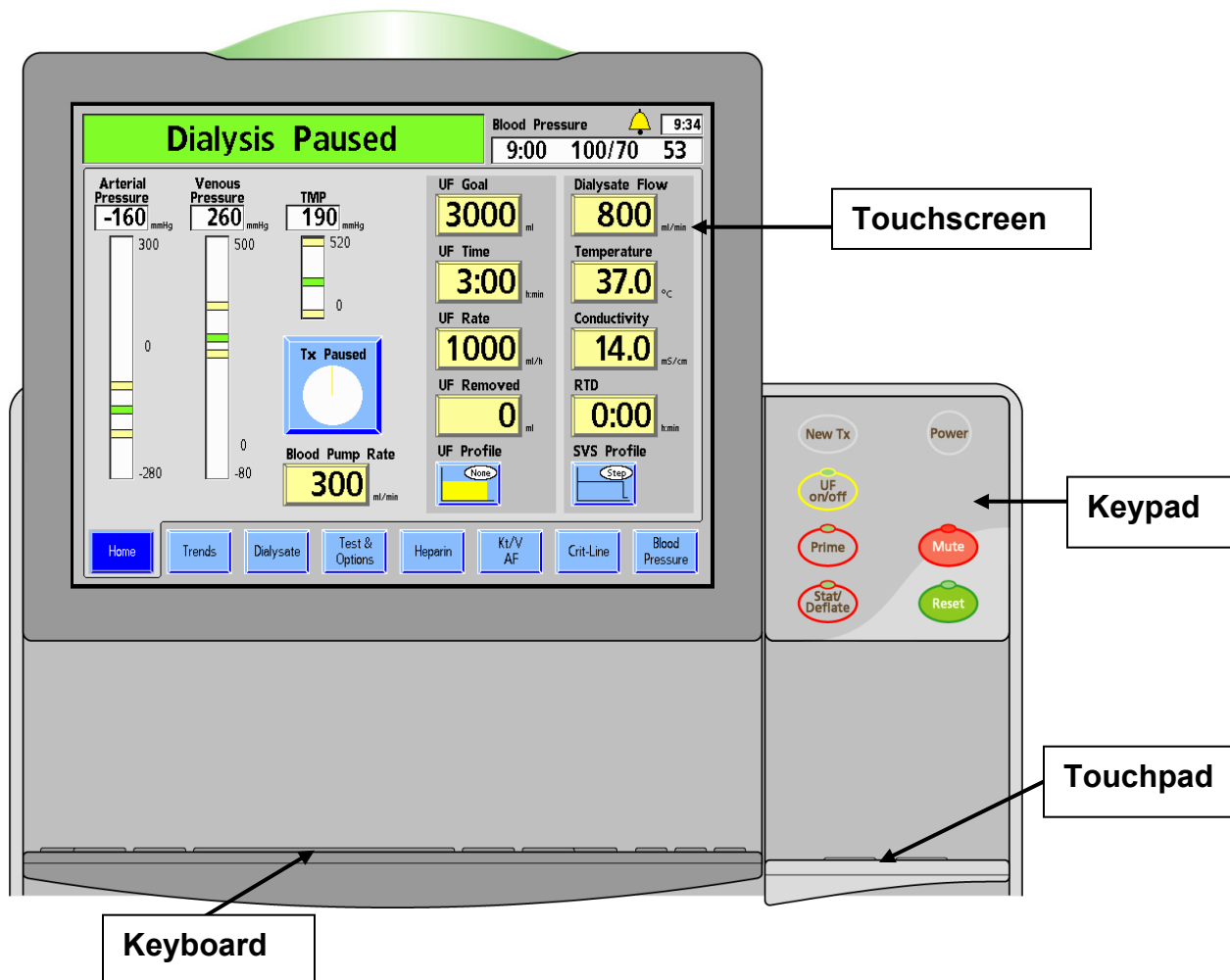

Figure 3 – The Components of the Control Panel

Control Panel Keypad

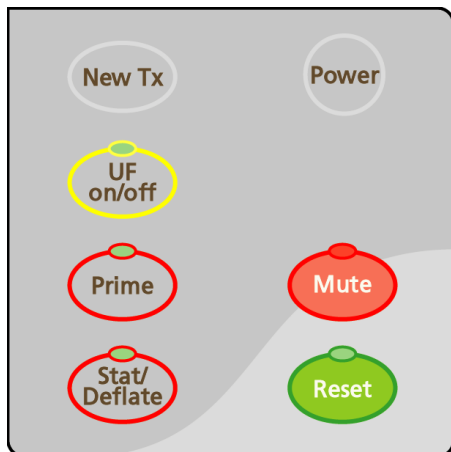

Figure 4 – Control Panel Keypad

The Control Panel Keypad contains seven keys associated with starting or stopping the basic power and alarm aspects of any dialysis treatment. The table below lists each key and its function.















Caution: Use a finger to press the keys and the touchscreen. Use of objects to press the keys or touchscreen may result in damage or premature failure.



Note: Pressing any control panel key (except for the **Power** key) while displaying CDX or in Low Power Mode will switch the machine back to full power Dialysis Mode. See page 297 for more information on CDX and page 341 for information about Low Power Mode.

Table 1 – Control Panel Keypad Keys

Press ...	To ...
	Turn the machine on. Hold for one second to turn the power off and, if blood is sensed, the machine will power down with an audible alarm. If the CDX Auto On feature is running for the day, pressing the Power key will only cause the machine to power down for two minutes, after which it will restart. See page 347 for more information about the CDX Auto On feature.
	Silence an alarm for two minutes or until another alarm occurs. The red light above the key is on if an alarm is muted. Functional software version 2.72 or later: A muted alarm is also indicated in the Dialogue Box, see page 31 for more information.
	 Note: The following alarms are muted for an extra four minutes (for a total of six minutes) when using a <i>bi</i> bag disposable for the bicarbonate source: Conductivity Low, Conductivity High, <i>bi</i> bag: Cond Low, Bicarb Cond 2 Low, Bicarb Cond 2 High, Low Temperature, and High Temperature.

Press ...	To ...
	<p>(New Treatment) Erase the current treatment information and move the summary information to the previous record in the “Trends” screen.</p> <p>Press the CONFIRM key on the touchpad or Enter on the keyboard to complete the action. To cancel, press the Escape key on the touchpad or the Esc key on the keyboard.</p> <p>If the Service Mode ‘Default Rx Screen’ option is set to ‘Yes’ and no PatientCard is used, pressing and confirming the New Tx key will instead display the “Default Parameters” screen. See page 119 for more information.</p>
	<p>Reset the machine after an alarm.</p> <p>Press and hold for two seconds to spread the alarm window by 300 mmHg for arterial and venous pressures and fully open the transmembrane (TMP) pressure window for 30 seconds. The light above the Reset key will not be on.</p> <p>During a blood leak alarm, press and hold for three seconds to override the alarm and keep the blood pump running for three minutes. The light above the Reset key will be on during an override.</p> <p> Note: The Reset key is only used to reset alarms; it does not reset or cancel changes to a parameter.</p>
	<p>Start an unscheduled, manual blood pressure measurement when the cuff is deflated, or instantly deflate the inflated blood pressure cuff.</p> <p> Warning! Too frequent measurements can cause injury to the patient due to blood flow interference.</p> <p> Note: Certain versions of the blood pressure module require a 30 second delay between blood pressure measurements.</p> <p>Note: Pressing the Stat/Deflate key while displaying CDX will only exit CDX. The operator must then press the Stat/Deflate key again in order to take a blood pressure measurement.</p>
	<p>Turn the ultrafiltration pump on or off. During ultrafiltration, the green light is illuminated. This light will flash when ultrafiltration is interrupted.</p> <p> Note: When the UF pump is turned off, there is no “minimum” ultrafiltration occurring.</p>
	<p>Prime the extracorporeal blood circuit. Pressing Prime will keep the blood pump running when air is sensed in the venous blood chamber and an air detector alarm is present (as is the case during initial set up when the blood circuit tubing is empty). The pump will run for:</p> <p>Two minutes, or</p> <p>Until an adequate fluid level is detected by the ultrasonic sensors in the level detector module, or</p> <p>Until the volume set in Service Mode is reached.</p>

Treatment Display Section

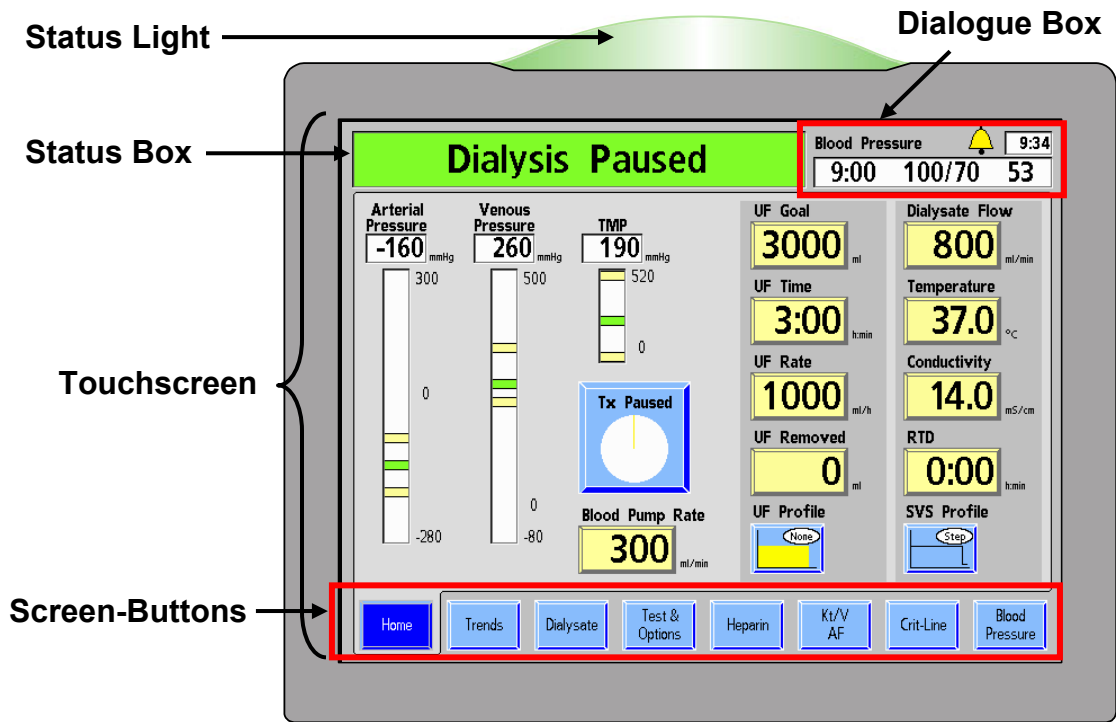

Figure 5 – Control Panel – Treatment Display Section

The Treatment Display section is used to display information and access and set all treatment parameters.

At the top of the Treatment Display Section is the Status Light. The Status Light indicates the machine’s status with an illuminated dome. Its color matches the Status Box (see Figure 5). The lights (red, green, or yellow) are used to display status information. This allows clinic personnel to monitor the status of each 2008T hemodialysis machine from a distance during treatment. There are several selections for the meaning of the lights described in the ‘Beacon’ option on page 321. When the Status Light flashes green with the display screen off, the machine is in Low Power Mode. To turn the display back on, simply touch the touchscreen, keyboard, or touchpad. For more information about Low Power Mode, see page 341.

The Status Box appears at the top left corner of every treatment screen. During normal operation it displays the operational mode of the machine—Dialysis or SLED. During alarm situations, it displays an informational message. It may also prompt the operator for a specific action in situations when the treatment parameters are being set.

To the right of the Status Box, is the Dialogue Box. During normal treatment, the Dialogue Box displays the current time, the time of the last blood pressure reading and the patient’s blood pressure and pulse rate at that time. Starting in functional software version 2.72, the Dialogue Box also displays the **Bell** button (see Figure 6). Selecting the **Bell** button displays a pop-up window allowing the operator to adjust the alarm volume **+** (plus) or **–** (minus) buttons. If an alarm is muted, the **Bell** button displays a red X over it.

The Dialogue Box also displays advisory messages when an action is required by the operator (for example, to correct a treatment parameter that is outside the range of allowable limits) or when more information about a situation is available. For a listing of advisory messages, see the “Troubleshooting” section on page 202.

<p>Dialogue Box</p>	<p>Bell button Current Time Pulse</p> <p>Blood Pressure 10:51</p> <p>10:45 120/90 100</p> <p>Time of last BP reading Blood Pressure</p>
<p>Adjusting Alarm Volume</p>	<p>Alarm Volume</p>
<p>Alarm Volume Locked at 'Medium'</p>	<p>Alarm Volume</p>
<p>Alarm Volume Adjusted by External Knob</p>	<p>Alarm Volume</p> <p>Use external knob to adjust</p>
<p>Alarm Muted</p>	<p>Blood Pressure 10:51</p> <p>10:45 120/90 100</p>
<p>Dialogue Box Advisory Message</p>	<p>Reset Treatment? CONFIRM or Escape</p>

Figure 6 – Dialogue Box Features (functional software version 2.72 with 2008T BlueStar Premium)

The treatment display screen, or touchscreen, contains the area for viewing and entering the various treatment settings. Adjustments to treatment parameters and options are made using buttons. For a description of the various types of buttons and their states, see Figure 7 on the next page.











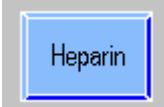

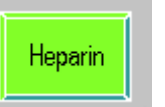

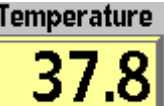
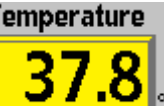

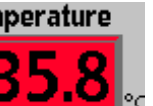
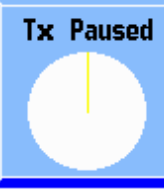

	Normal Light blue or light yellow with black text	Selected Dark blue, dark yellow, or gray X in toggle—must confirm or escape	Unavailable Gray	Running Green	Out of Range Red
Screen-Buttons					
Parameter-Buttons					
Action-Buttons	 	 			
Movement-Buttons					
Toggle-Buttons					

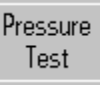
Figure 7 – Button Types and States

Screen-buttons along the bottom edge of the display screen are common to all treatment screens in the Dialysis and SLED programs. See Table 2 below for a description of these screen-buttons. Specific information regarding each treatment screen can be found in Chapter 3, “Setting Treatment Parameters” and Chapter 4, “Monitoring the Treatment.”

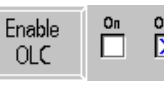
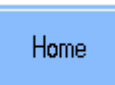
Table 2 – Common Screen-Buttons

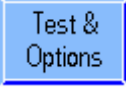
Select ...	To ...
	View current treatment data including treatment time remaining, UF data, arterial, venous, and transmembrane pressures, and dialysate data.

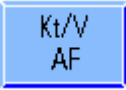
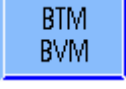
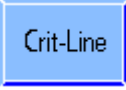
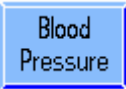
Select ...	To ...
	View charts that provide graphic views of treatment effectiveness (Kt/V), sodium variation system (SVS) and ultrafiltration (UF) profiles, and patient's blood pressure over time. Displays the summary data of the patient's treatment progress.
	View and select acid/bicarbonate concentrate type, bicarbonate, sodium, electrolyte concentrations, and conductivity settings.
	View Pressure test, Alarm test, and Diasafe test options and results. View treatment options for low volume and single needle patients, high flux dialyzers, enter a patient ID number, and access Auto Prime, Assisted Reinfusion, and dialysate sampling features.
	View options for administering heparin gradually over the course of the treatment and/or as a bolus injection. This button turns green during treatment when the heparin pump is running (functional software version 2.34 or later).
	View estimate of treatment effectiveness based on the actual dialyzer clearance. View the Access Flow messages and data
 Or 	View arterial and venous blood temperature data with machines equipped with the optional Blood Temperature Module. For more information, see <i>Blood Temperature Monitor Operating Instructions</i> (P/N 470164). View the relative blood volume data and trends with machines equipped with the optional Blood Volume Module. For more information, see <i>Blood Volume Monitor Operating Instructions</i> (P/N 490041). When the Crit-Line in a Clip (CLiC) device is used during the treatment, the "Crit-Line" screen replaces the "BTM BVM" screen. The "Crit-Line" screen can be configured (in Service Mode) to show either blood volume or hematocrit. Additionally, the "Crit-Line" screen can alternately display blood pressure or oxygen saturation graphs during the treatment. Most of the commonly viewed data from other screens are also grouped on the "Crit-Line" screen for convenient monitoring. For more information, see the <i>2008T Hemodialysis Machine with CLiC User's Guide</i> (P/N 490206).
	View all pulse and blood pressure test results taken during treatment. Blood pressure alarm limits and inflation pressure and frequency of blood pressure tests are set in this screen.

Fold-Down Keyboard



Figure 8 – Control Panel – Fold-Down Keyboard

The keyboard is located directly below the display screen. It folds down for entering treatment parameter values or making selections inside the treatment screens and folds up again to prevent accidental changes. Folding up the keyboard also provides an unobstructed view of the blood pump and arterial and venous drip chambers.

Table 3 – Keyboard Keys

Press ...	To ...
	Enter numerical values when setting parameters for such treatment options as ultrafiltration rate, times, goal, and volumes.
	Scroll up or down a list of parameter choices or to increase ↑ (up arrow) or decrease ↓ (down arrow) parameter values. To speed up the rate at which the value changes, press and hold the key down. Note: (CDX only) holding down the Shift key while pressing an arrow key will shift to the secondary function printed on the key.
	Save a treatment parameter entry or confirm an action initiated on the display screen. The Enter key is a backup, safety feature designed to prevent accidental changes to the intended treatment parameters. Note: The Enter key functions the same as the CONFIRM key on the touchpad
	Void the current entry and return to previously entered parameter value before CONFIRM is pressed. If the on-screen cursor disappears, press the Esc key to show it again. Note: The Esc key functions the same as the Escape key on the touchpad.
	CDX only: Pressing the blue CDX key will switch between displaying Dialysis or SLED and the optional Clinical Data Exchange (CDX) system. For more information, see page 297.
	CDX only: The blue Fn (Function) Lock key selects the secondary function of keys with blue function numbers (F1-F12) at the top of the keyboard. Press the Fn Lock key and then press a function key to select that function. The Fn Lock light in the upper left corner of the keyboard indicates the lock status: when the light is on, the function lock is on. Press the Fn Lock key again to turn off the function lock. Note: Older versions of the keyboard instead feature a Fn key which must be held down to select the secondary functions of the blue function number keys.

Fold-Down Touchpad

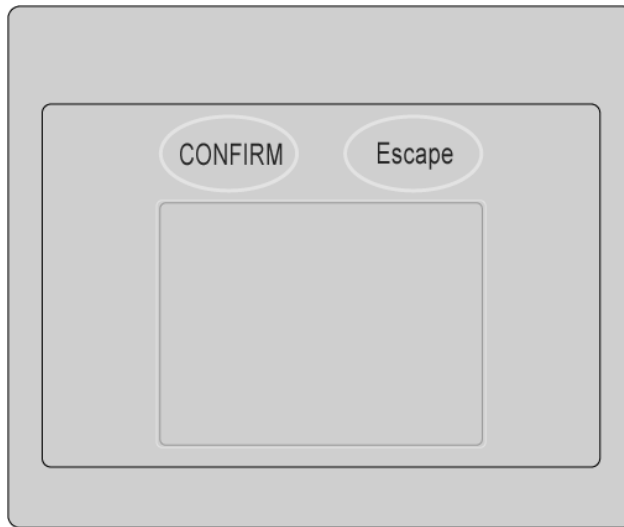
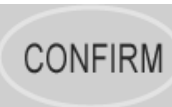
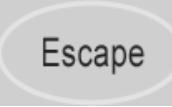



Figure 9 – Control Panel – Touchpad

The touchpad is located directly below the Control Panel Keypad. It folds down to reveal a touchpad which is used to move the on-screen cursor arrow. It also features two keys:

Table 4 – Touchpad Keys

Press ...	To ...
	<p>Select a field highlighted by the on-screen cursor arrow.</p> <p>Save a treatment parameter entry or confirm an action initiated on the display screen. The CONFIRM key is a backup, safety feature designed to prevent accidental changes to the intended treatment parameters.</p> <p>Note: The CONFIRM key functions the same as the Enter key on the keyboard.</p>
	<p>Void the current entry and return to previously entered parameter value before CONFIRM is pressed.</p> <p>Note: The Escape key functions the same as the Esc key on the keyboard.</p>
Touchpad	<p>Tap the touchpad to select a field highlighted by the on-screen cursor arrow </p> <p>Tap the touchpad again to confirm a change.</p>



Note: The on-screen cursor arrow will disappear if not moved for five seconds. Move the cursor using the touchpad for it to reappear.

It also disappears when a value is entered but not yet confirmed. To display the cursor again, press the **Escape** key to cancel the change or press the **CONFIRM** key to confirm the change.

The Back Panel

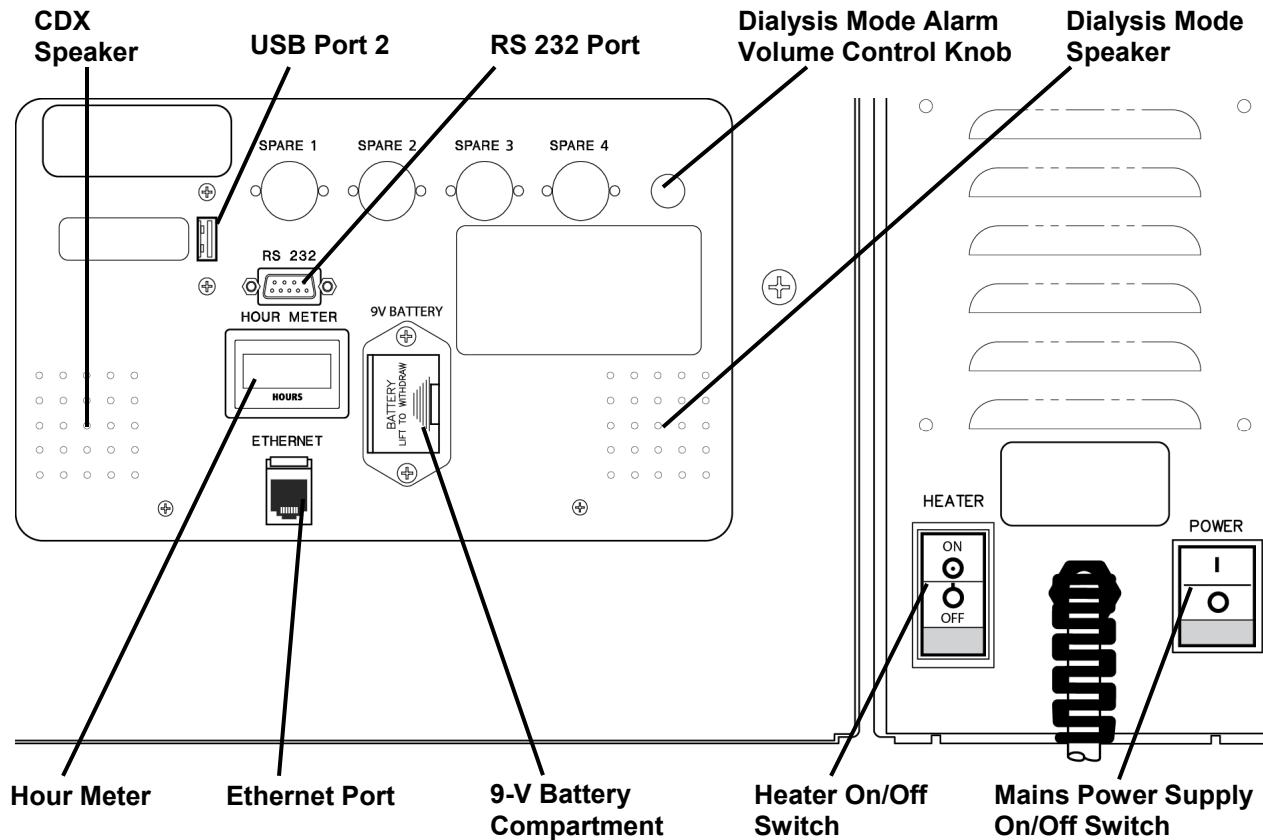



Figure 10 – Back Panel (with obsolete external hour meter and volume knob)

The back panel of the 2008T hemodialysis machine is located on the back of the machine at the top of the cabinet. It contains additional controls like audible volume, switches and various connections.

Table 5 – Back Panel Features

Feature	Function
CDX Speaker	Sound from the CDX PC (optional) will be produced by this speaker only when the machine is displaying CDX (see page 297 for more information). It is muted when displaying Dialysis/SLED treatment screens.
USB Port 2	Expansion for CDX PC (optional). Only self-powered USB devices may be connected when the 2008T hemodialysis machine is used with a patient.
	 <p>Warning! Do not connect devices requiring an external AC power connection to the machine's USB ports (for example: printers, card readers, or USB hard drives that plug into a wall outlet). Only freestanding (self-powered) devices such as USB flash drives are permitted. Inserting a powered USB device into your machine's USB ports may adversely affect the machine's electrical safety and patient isolation.</p>

Feature	Function
RS 232 Port	Electrically isolated RS 232 serial interface connector; hard wired, used for display terminal connection.
Volume Control (Dialysis Mode Only)	<p>Used to adjust the volume (sound pressure level) of the dialysis machine audible alarms. Does not affect the volume from the separate CDX speaker.</p> <p>For functional software version 2.72 or later, this external volume control knob may be disabled or absent. In this case, the alarm volume is controlled using buttons on the touchscreen. For more information, see page 31.</p>
Dialysis Mode Speaker	The Dialysis Mode speaker makes two different sounds: a Low Alarm sound, and a High Alarm sound. The two sounds are distinct; the first one is used for lower priority alarms, and the second for more important alarms.
Hour Meter	<p>This displays the number of hours the machine has run over its lifetime. See the “2008T Preventive Maintenance Procedures Manual” (P/N 508033) for information on scheduled maintenance.</p> <p>For functional software version 2.72 or later, this external hour meter may be disabled or absent. In this case, the machine hours are displayed on the “Select Program” screen (see Figure 22) and does not increment when the machine is running in Low Power Mode. For more information about Low Power Mode, see page 341.</p>
Ethernet Port	10/100 Ethernet connection for the CDX PC (optional); electrically isolated.
9-V Battery (Power Failure Alarm)	9-V heavy duty alkaline battery for main power failure. A steady, audible alarm will immediately sound for seven minutes that cannot be silenced with the Mute key. It can be silenced manually, however, by removing this 9-volt battery. See “Replacing the 9-Volt Battery” on page 278 for more information.
Heater On/Off Switch	This switch turns the power to the dialysate heater on or off. This switch must be in the ON position during treatment.
Mains Power Supply On/Off Switch	This switch turns the power to the whole machine on or off. This switch must be in the ON position (I) to operate the machine. If the CDX Auto On feature is running for the day, setting this switch to OFF will prevent the machine from automatically turning back on. See page 347 for more information about the CDX Auto On feature.



Note: Periodically check the power cord for damage (fraying, over-heating, cuts, scrapes, etc.)

PatientCard Reader (Optional)

The optional PatientCard Reader is housed inside the IV Pole mount on the right side of the 2008T hemodialysis machine. It is used to read the patient ID, prescription, patient settings, and treatment history stored on the PatientCard. The PatientCard Reader can also be used to write to a brand new PatientCard to save the patient's name, birthdate, and ID number. At the end of treatment, the updated treatment information is saved to the PatientCard. For more information, see page 126.



Note: The operator must select **Dialysis** from the “Select Program” screen to access information on the PatientCard.

Note: If the machine does not read the PatientCard within five seconds, remove the PatientCard and reinsert it to try again.

The PatientCard is inserted into the PatientCard Reader with the chip facing toward the machine cabinet (see below).

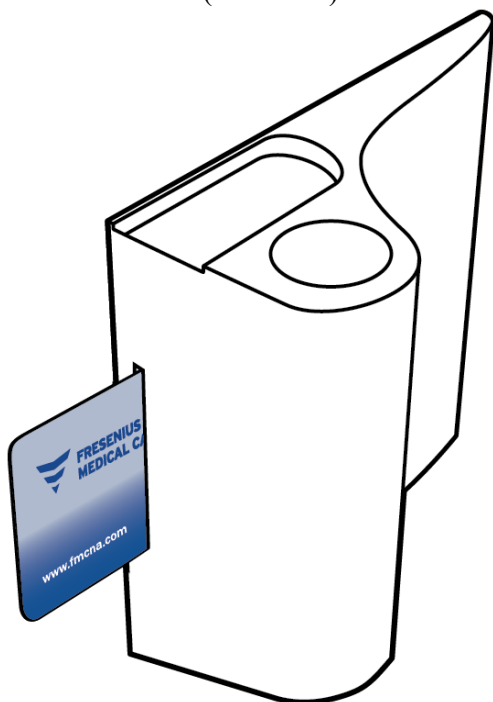

Figure 11 – Optional PatientCard Reader in the IV Pole Mount

Be sure to label the PatientCard per facility policy and protocol with the patient's ID number before using it for treatment.



Note: The PatientCard can be used with other equipment connected to a UDL card reader like the patient scale. Contact Fresenius Medical Care Spare Parts department or your sales representative for more information and pricing.

Note: When the PatientCard is used, concentrate names ending in -13 (used for barrel containers) will be displayed with an -08 ending (normally used for jugs). This only affects the display; the concentrate itself is not affected.

Modules

The modules accompanying the 2008T hemodialysis machine are located just below the control panel. The Arterial Drip Chamber, Blood Pump, Heparin Pump, and Level Detector modules contribute to the task of transmitting the blood from the patient, through the dialyzer and back to the patient. The red lines on the modules are guides for the arterial bloodline (from patient to the dialyzer). The blue lines are guides for the venous bloodline (from dialyzer to patient).

Any machine can be set up for a pre-pump or post-pump arterial chamber, or single-needle dialysis (requiring two blood pumps) by adding modules, or rearranging their order.

The preferred arrangements, shown in Figure 26 and Figure 27 on page 60, can help to simplify the routing of the blood tubing and minimize the possibility of kinking the bloodline.

Additionally, the internal blood pressure module is explained on page 44 and the shunt interlock is explained on page 48.

The Arterial Drip Chamber Module

The arterial drip chamber module is a panel with guides for blood tubing and a holder for the arterial drip chamber. The button used to raise the arterial drip chamber level is located on the Blood Pump module.

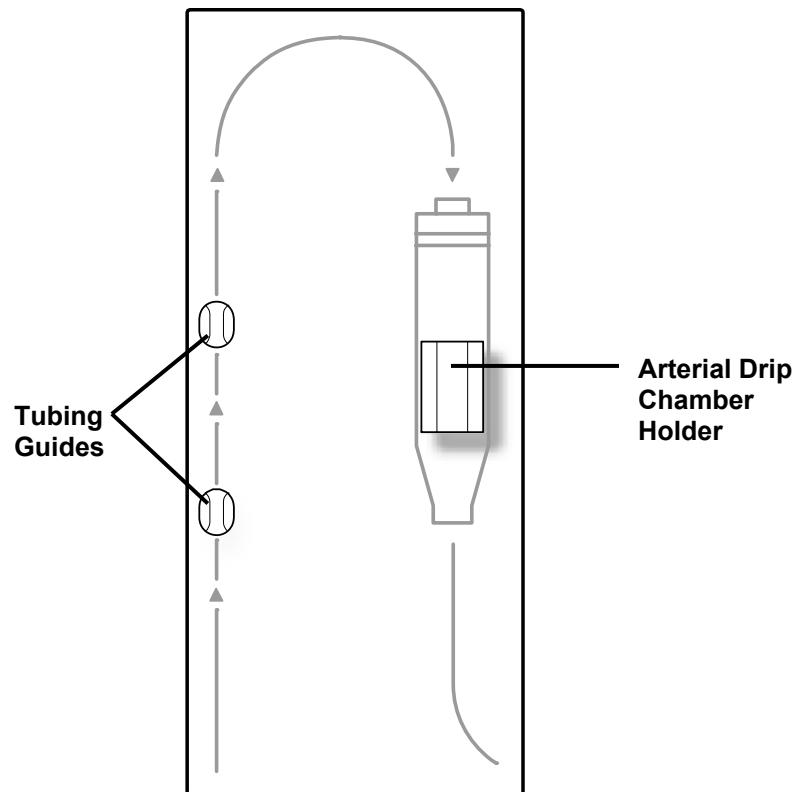

Figure 12 – The Arterial Drip Chamber Module

The Blood Pump Module

The blood pump draws blood from the patient and pumps it to the dialyzer and back to the patient in a closed circuit. To accomplish this, the pump segment of the blood tubing is threaded through the pump housing along a circular track. As the pump rotor rotates, twin rollers squeeze the pump segment, pulling and pushing the blood through the blood pump segment. The speed of the pump can be adjusted using the arrow keys on the blood pump or the **Blood Pump Rate** button on the “Home” screen (see page 94 for more information). The blood pump can be stopped by pressing the **Start/Stop** key or by opening the blood pump door. When the door is open, the diameter of the pump segment is shown in the display window.

Pressing the single ▲ key on the Blood Pump Module activates a small pump that raises the fluid level in the arterial chamber. This ▲ key (level adjust) can be used only to raise the level of blood in the chamber, and cannot be used to lower it. This is to avoid introducing air into the blood flow.



Warning! The ▲ key (level adjust) on the Blood Pump module can only be used to raise the level in the arterial chamber. Do not press the level adjust key so long that the pressure transducer protector becomes wet. Wet transducer protectors must be replaced to avoid erroneous pressure readings.



Note: A separate hand crank is supplied with the pump at the back of the machine that can be used to return the blood to the patient in case of a power failure.

Note: If the machine is in Low Power Mode (display screen is off and the Status Light flashing green), power to the Blood Pump module is turned off. To turn the blood pump module back on, simply touch the touchscreen, keyboard, or touchpad. For more information about Low Power Mode, see page 341 for more information.

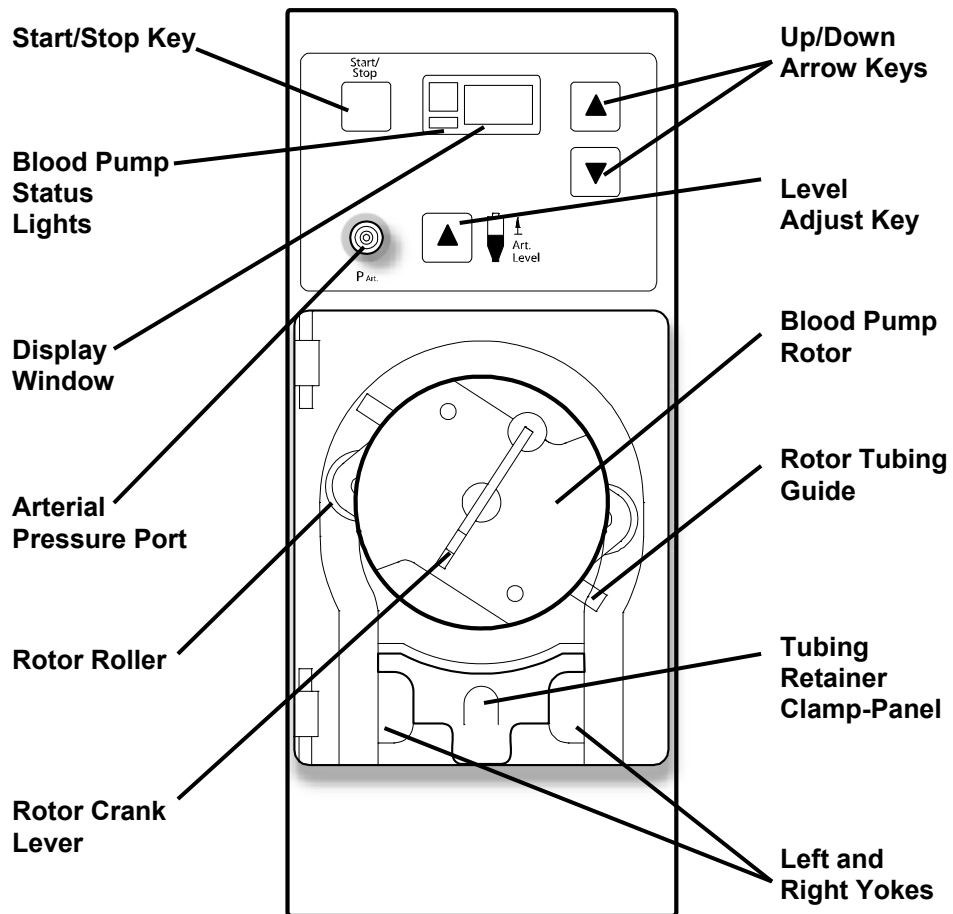

Figure 13 – The Blood Pump Module

The following table describes the operational features of the blood pump.

Table 6 – Blood Pump Features

Feature	Function
Start/Stop Key	Starts and stops the blood pump. Opening the door will also stop the blood pump.
Pressure Port	Line from arterial drip chamber is connected to a transducer protector and attached here to provide arterial pressure readings.
Level Adjust Key	Pressing the ▲ key (level adjust key on the Blood Pump module) will raise the level of the fluid in the arterial drip chamber.
Display Window	Displays the blood flow rate setting in increments of 5 ml/min during blood pump operation. When the door is open it displays the pump-segment diameter in mm. The left side of the Display Window features a green light, lit when the pump is running, and a red light for alarms.
Blood Pump Rotor	The Blood Pump Rotor turns to move the blood along the Blood pump tubing segment. In an emergency the rotor can be turned with a separate hand crank (on the back of the machine) to manually return the blood, see page 168 for more information.

Feature	Function
Up/Down Keys	Increases the speed of the pump when Up arrow (▲) is depressed, decreases the pump speed when Down arrow (▼) is depressed. When door is open, simultaneously press the ▼ and ▲ keys and then press the ▼ or ▲ key to select the pump segment diameter.
Tubing Retainer	A spring-loaded device that secures the pump segment in place.

The Heparin Pump Module

The heparin pump provides a means of injecting heparin into the blood circuit gradually over the course of the treatment and/or as a bolus. The pump can accommodate a variety of syringes that are commercially available. The pump works in conjunction with the “Heparin” screen where such parameters as the size and type of the syringe, infusion rate, infusion time, and bolus amount of heparin to be infused are selected.

If heparin is infused manually (by pushing in the carriage lock button while pushing on the slide carriage), the volume will not be added to the displayed amount, and must be added to the total heparin amount. Manually moving the carriage to infuse heparin is not recommended.

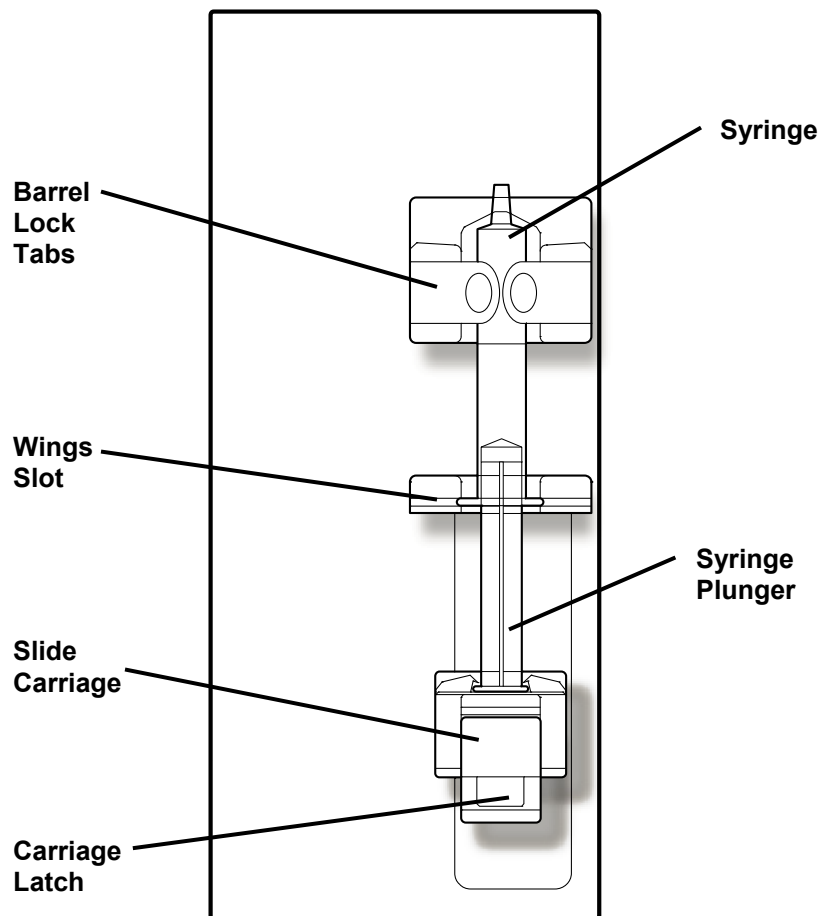

Figure 14 – The Heparin Pump Module (shown with syringe)

The Level Detector Module

The Level detector module is used to monitor the level of fluid in the venous drip chamber. The venous drip chamber is mounted inside its holder and the blood tubing leading back to the patient is threaded through the venous line clamp below it. An ultrasonic device inside the chamber holder monitors the drip chamber for the presence of air. If the level of blood in the chamber is too low and air is detected, the machine alarms, the blood pumps stops, and the clamp occludes the venous blood tubing.

An optical sensor located below the occlusion clamp recognizes whether or not blood, an opaque fluid, is detected in the venous line. When the dialysate supply lines are on the shunt, and the shunt door is closed, and blood is not sensed, the audible alarm is suppressed entirely.

Also located on the front of the module is a pressure port. The small monitor line from the drip chamber is connected to the transducer port. The pressure of the venous side of the blood circuit is read by the transducer mounted on the inside of the module, and the pressure is displayed in the “Home” screen.

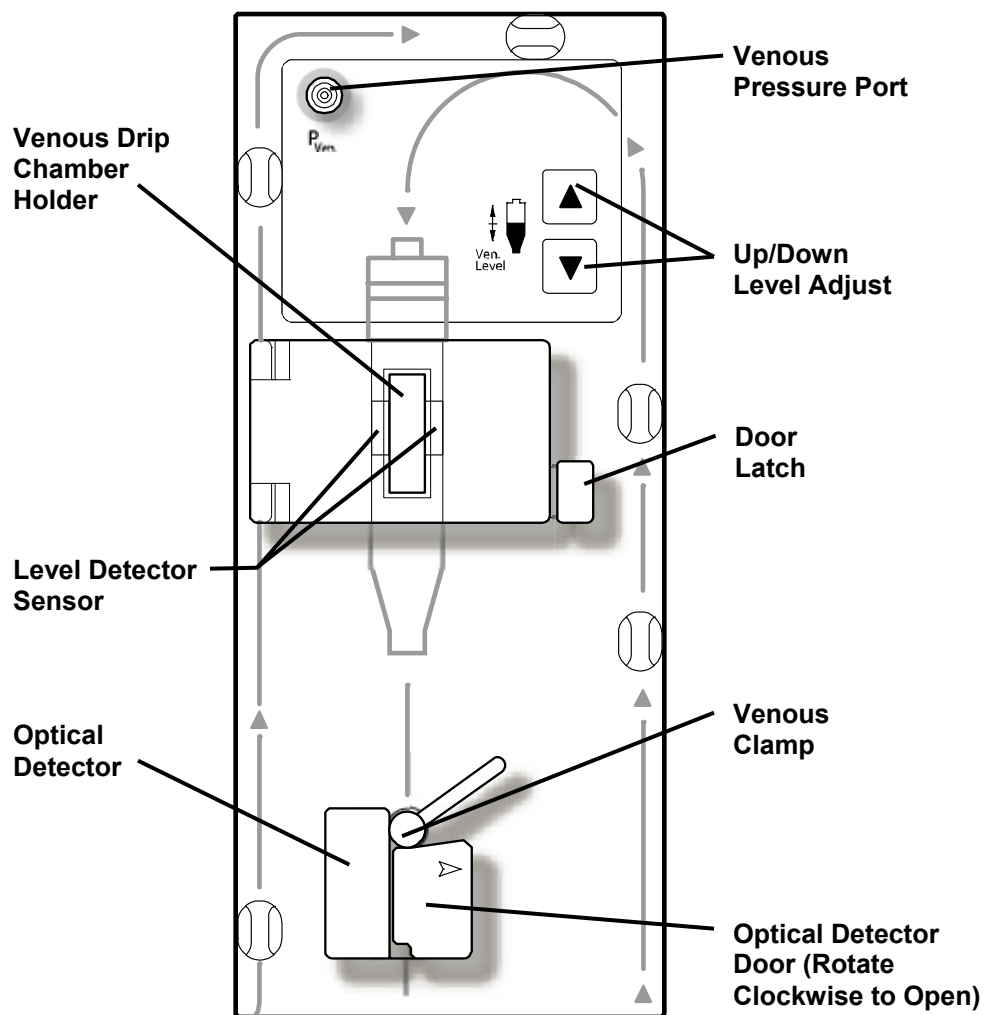

Figure 15 – The Level Detector Module

Table 7 – Level Detector Features

Feature	Function
Venous Pressure port (P _{Ven.})	Line from venous drip chamber is connected to a transducer protector and attached here to provide venous blood pressure readings.
Venous Drip Chamber Holder	Holds the drip chamber and aligns it with the ultrasonic level detector sensor. Latching door secures chamber in place.
Level Adjust Keys	Raises the level of the fluid in the chamber when the ▲ (up arrow) key is pressed, and lowers the level when the ▼ (down arrow) key on the level detector is pressed.
Optical Detector	Secures venous blood tubing leading back to the patient and houses venous line clamp and optical detector. The optical detector distinguishes between opaque fluid (blood) and a transparent medium such as saline.
Venous Line Clamp	Automatically occludes the blood tubing leading back to the patient during blood-alarm situations.



Note: If the machine is in Low Power Mode (display screen is off and the Status Light flashing green), power to the Level Detector module is turned off. To turn the Level Detector module back on, simply touch the touchscreen, keyboard, or touchpad. For more information about Low Power Mode, see page 341 for more information.

Blood Tubing System

The dialysate delivery machine can be used with a variety of blood-tubing configurations. The modules (Arterial Drip Chamber, Blood Pump, Level Detector, and Heparin Pump) can be arranged on the 2008T hemodialysis machine in a variety of ways to allow for pre- or post-arterial pump pressure monitoring. The machine can accommodate most standard blood tubing that have pump segments ranging from 2 to 10 mm internal diameter. An additional single needle blood pump and special arterial line with two pump segments and a compliance chamber is required on a machine set up for single-needle dialysis.

Blood Pressure Module

The Blood Pressure module is located internally with the pressure tubing running from the back of the machine to the cuff. The module can automatically take the patient's blood pressure at defined intervals, record the systolic, diastolic, MAP, and pulse values, and plot out the results on the "Blood Pressure" screen, "Trends" screen, and optional "Crit-Line" screen. The pressure cuffs come in a variety of sizes to accommodate low volume through large adult patients. The medium size comes standard with the 2008T hemodialysis machine and can accommodate patients with upper arm circumferences of 24-34 centimeters. Optional larger and smaller cuffs are also available.



Note: Circumferences may vary with other cuff styles.

The Dialysate Path

The 2008T hemodialysis machine is a three-stream dialysate delivery machine: it mixes the dialysate from three different sources and sends it to the dialyzer for treatment. The three main parts of the dialysate are: purified (RO) water, acid concentrate, and bicarbonate concentrate. After the machine heats and degasses the water, it mixes in the concentrates to form dialysate. The machine then filters the dialysate with the DIASAFE *plus*_{US} filter (see page 277). The ultra-pure dialysate pumps through dialysate lines to the ports on the side of the dialyzer. Meanwhile, the blood pumps through the bloodlines connected at each end of the dialyzer. The blood and dialysate meet in the dialyzer but never touch. The dialysate pulls waste from the patient’s bloodstream and then washes it out the drain. The Balancing Chamber makes sure that the incoming flow of the dialysate is equal to the volume of the outgoing flow to control ultrafiltration from the patient’s body. Ultrafiltration (UF) is the process of removing excess fluid during the treatment. The fluid that is removed is called UF Removed and the value is displayed on the machine’s “Home” screen.

The Dialysate Section

The Dialysate Section contains connectors for acid and bicarbonate concentrates.

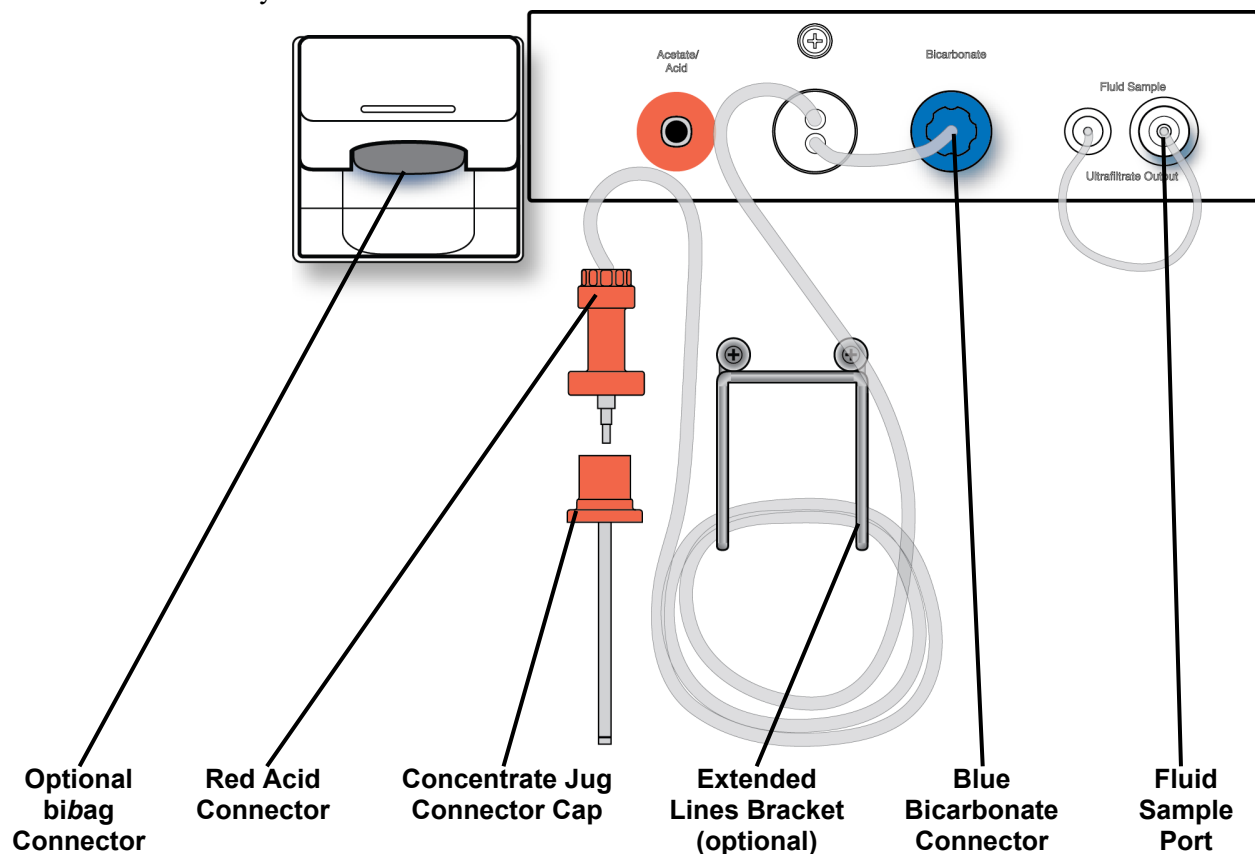

Figure 16 – The Dialysate Section



Note: The acid and bicarbonate lines can be extended to ten feet in length. Contact Fresenius Medical Care Spare Parts department or your sales representative for more information.

Table 8 – Dialysate Section Features

Feature	Function
Red acid and blue bicarbonate connectors	The concentrate connectors draw in acid and bicarbonate concentrates. The concentrate connectors pull out and connect to jugs of acid and bicarbonate concentrates or a concentrate central feed. When connecting, make certain to correctly match red to acid and blue to bicarbonate concentrates.
Concentrate Jug Connector Cap	The connector cap snaps onto the top of concentrate jugs. The Acid and Bicarbonate connectors connect to the cap so the machine can pull concentrate from the jugs.
Extended Lines Bracket	Optional bracket that is used to coil up extended acid and bicarbonate lines. The bracket can be mounted in a variety of locations.
Fluid Sample Port	The Fluid Sample Port allows testing of the UF pump.

bibag[®] System (Optional)

The *bibag* connector is part of the *bibag* system. It is a hardware option that allows use of a dry bicarbonate powder to make dialysate solution for the 2008T hemodialysis machine. The bicarbonate powder is contained in a bag called the *bibag* disposable. The machine adds purified (RO) water to the bag and pumps out the liquid bicarbonate concentrate to mix with the acid concentrate and more RO water.



Note: A “45x” concentrate must be selected in order to use the *bibag* system. When a 45x concentrate is selected with the *bibag* module installed, the machine will automatically detect whether or not a *bibag* disposable is connected upon entering Dialysis or SLED.

Note: When using the ‘Independent Cond Test’ Service Mode option (functional software version 2.72 or later) with the *bibag* disposable as the bicarbonate source, the 2008T hemodialysis machine will independently verify the conductivity and pH when running self-tests.

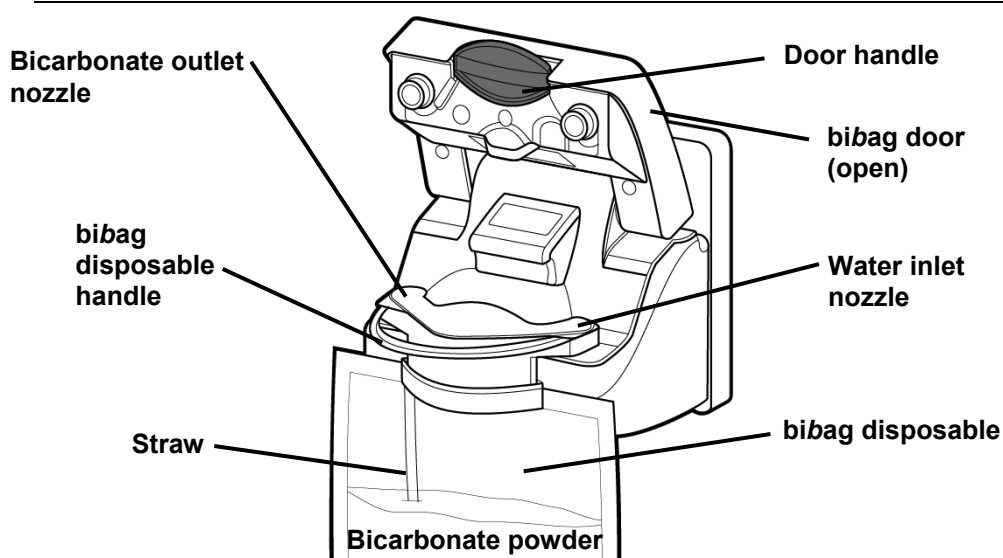

Figure 17 – The Optional *bibag* Connector (with *bibag* disposable)

Table 9 – Optional *bibag* Connector Features

Feature	Function
Optional <i>bibag</i> connector	The <i>bibag</i> connector connects the <i>bibag</i> disposable to the machine's dialysate path.
<i>bibag</i> Door	The <i>bibag</i> door covers the nozzles of the <i>bibag</i> connector. When the door is closed with no bag on the <i>bibag</i> connector, the nozzles form a loop in the dialysate path so the machine can rinse and disinfect the <i>bibag</i> connector. Pressing down on the <i>bibag</i> door locks the door in place. Lifting up on the door handle will open the <i>bibag</i> door.
Bicarbonate Outlet Nozzle	The machine pumps the liquid bicarbonate out of the <i>bibag</i> disposable through this opening.
Water Inlet Nozzle	The machine adds purified water to the bicarbonate powder in the <i>bibag</i> disposable through this opening.
<i>bibag</i> Disposable	<p>The <i>bibag</i> disposable is a bag filled with dry bicarbonate powder. At the top of the bag are special inlet and outlet ports. These ports match up with the nozzles on the machine's <i>bibag</i> connector.</p> <p>The Bicarbonate Outlet Nozzle connects to a straw inside the bag to reach the bottom of the bag.</p> <p>The handle on the bag allows you to easily lift the <i>bibag</i> disposable off the <i>bibag</i> connector.</p> <p>See the <i>bibag</i> estimated run time table on page 313 for more information.</p>

Dialyzer

The 2008T hemodialysis machine is compatible with commercially available dialyzers that are equipped with standard dialysate connections (ISO 8637). The dialyzer connects to the dialysate path via the dialysate lines on the shunt interlock.

The Shunt Interlock

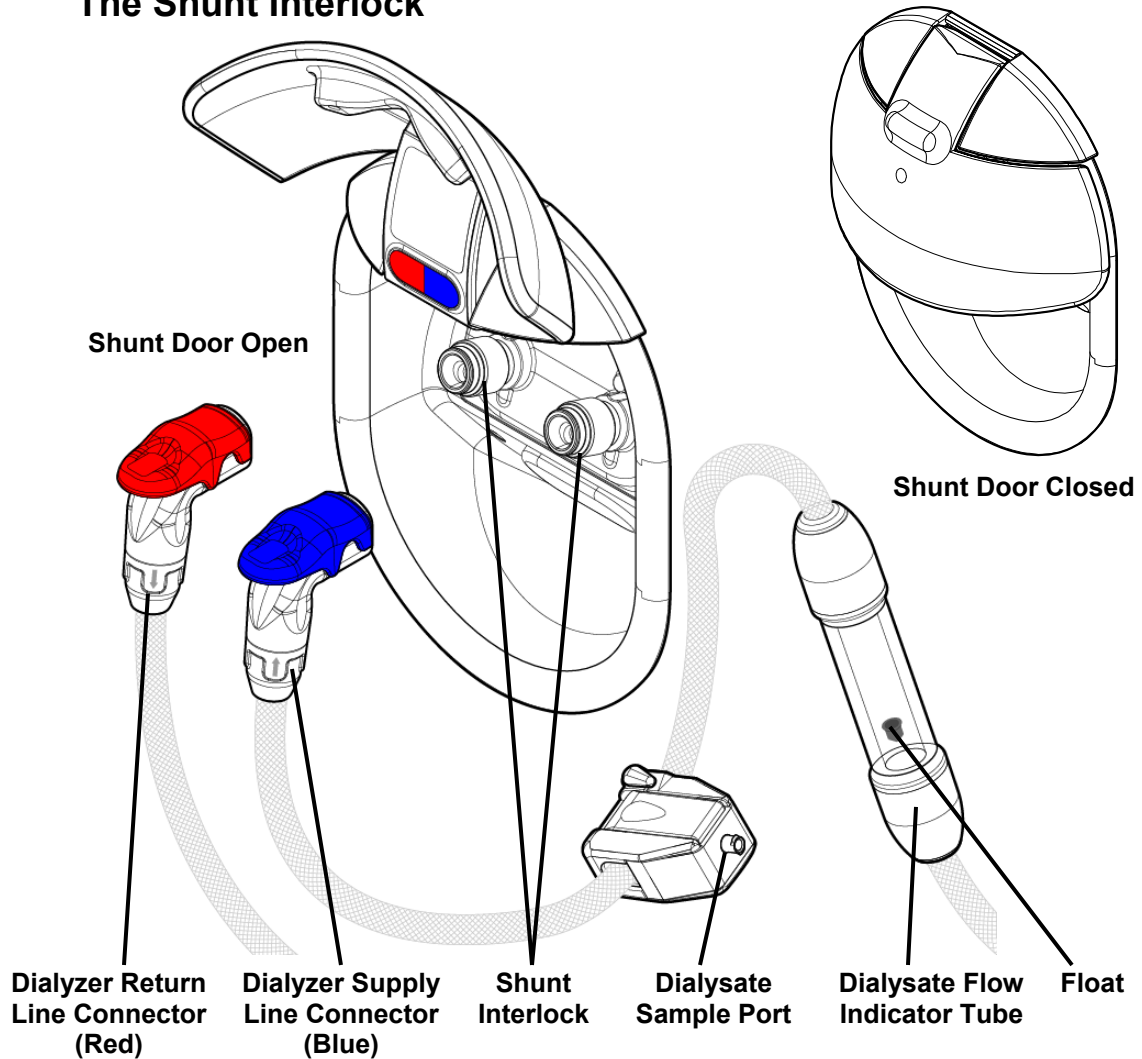

Figure 18 – Shunt Interlock, Flow Indicator & Dialyzer Connectors (viewed from back of machine)

The shunt interlock is located on the right side of the 2008T hemodialysis machine. It links the dialysate lines when they are connected to it. The shunt door flips up to reveal color-coded latching-connectors.

- Push the dialyzer connectors onto the shunt interlock to snap them in place
- Press down on the end of the red or blue lever and pull out the dialyzer connector to remove it from the shunt interlock

The dialyzer connectors attach to the dialyzer during dialysis or the shunt interlock during rinse programs. Make certain to correctly match red to red and blue to blue.

The blue dialyzer supply line features a dialysate flow indicator tube. A moving float in the tube allows the operator to see when dialysate is running through the lines and the dialyzer. The float does not move when the machine is in bypass mode. Lifting the shunt door will manually put the machine in bypass mode.

The dialysate sample port on the same line allows the operator to take a sample of the dialysate. For more information, see “Testing the Dialysate” on page 359.

IV Pole and Dialyzer Holder

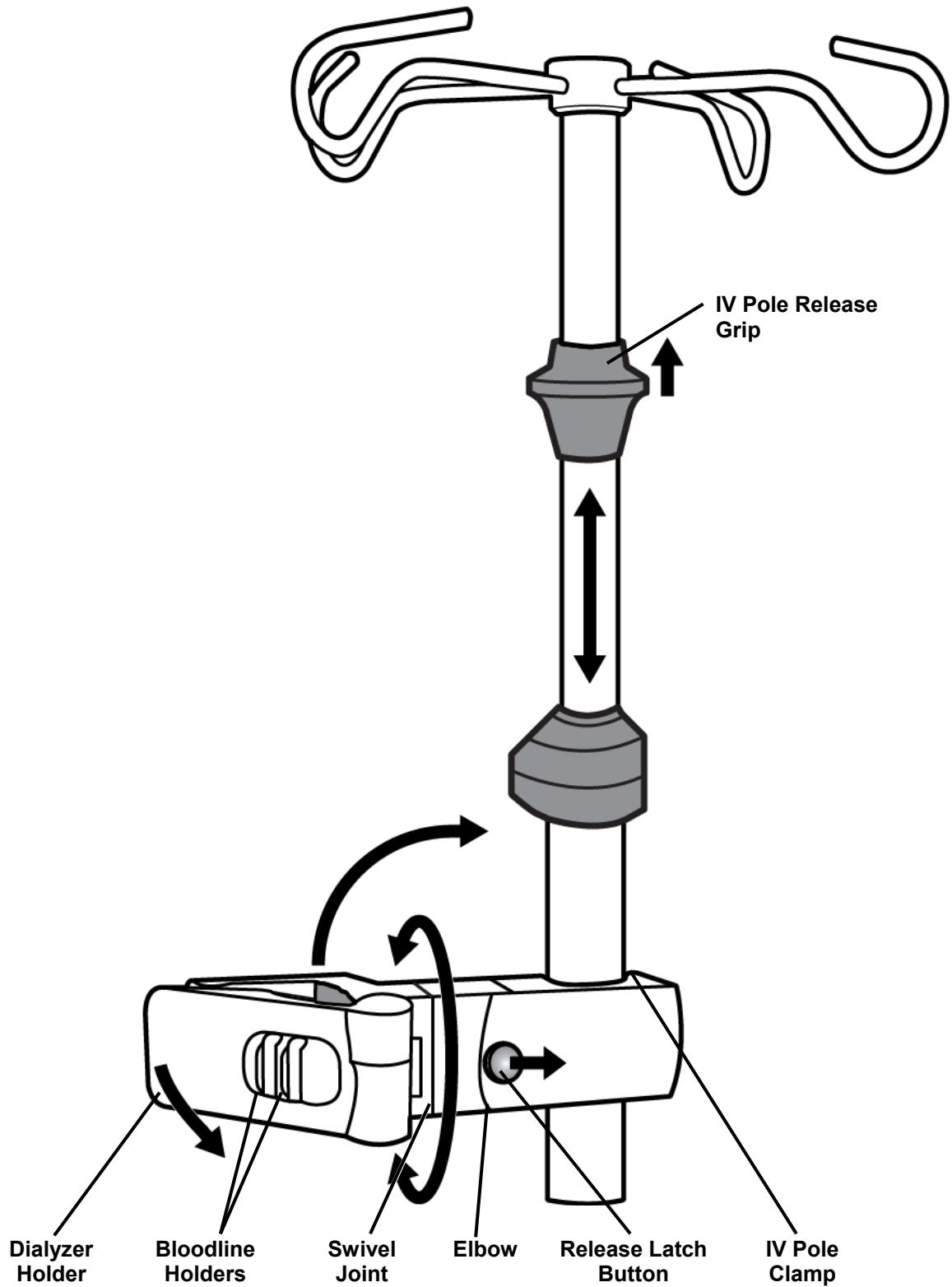

Figure 19 – The IV Pole and Dialyzer Holder

Table 10 – IV Pole and Dialyzer Holder Features

Feature	Function
IV Pole	<p>The IV pole is on the right side of the 2008T hemodialysis machine. This pole is utilized to hold various medications and solutions that may be required during a treatment.</p> <p>The IV pole mount near top half of the machine may feature the optional PatientCard Reader. For more information, see page 38.</p> <p>Near the top of the pole is a black release grip that is used to adjust the height of the IV pole. Lift up on the grip to slide the top of the IV pole up or down. Let go of the grip to lock the IV pole at its new height.</p>
Dialyzer Holder	<p>The dialyzer holder keeps the dialyzer in place during the treatment. The end of the dialyzer holder swings shut to clamp around a dialyzer. It rotates at the swivel joint on an arm. This is so the dialyzer can be easily flipped in the holder during treatment setup and end procedures.</p> <p>The opposite end of the arm clamps on the IV pole when the arm is straight. To move the arm up or down along the IV pole: slide the Release Latch Button toward the IV pole and bend the arm upward at the elbow. The arm's IV pole clamp will loosen and then the arm can move freely. To clamp the arm on the IV pole, straighten the arm at the elbow again.</p> <p>The dialyzer holder also has bloodline holders like the tubing guides on the machine's modules. Press the bloodlines into these holders to help keep them visible and free from kinks.</p>

Moving the Machine

The 2008T hemodialysis machine has wheels on the bottom to make it easy to move. Before moving the machine, make sure the IV pole is secured in its lower mount.

The wheel lock may need to be released before the machine will roll. The wheel lock is on the right side of the 2008T hemodialysis machine at the base. To unlock the wheels, press down on the front end of the foot pedal. To lock the wheels again, push down on the back end of the foot pedal.

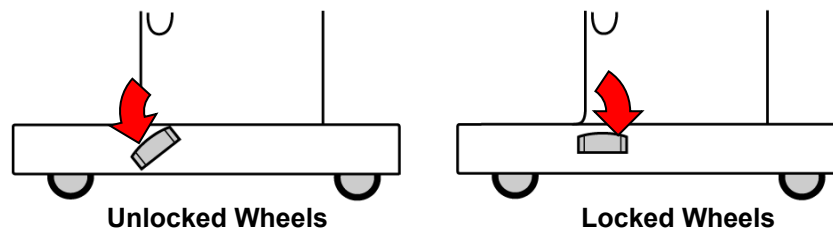

Figure 20 – The Wheel Lock



Warning! Tip Hazard. Do not push or lean against the machine when the wheel lock is set.

Warning! Be careful not to tip the machine when rolling it over uneven surfaces. Push the machine from the middle when moving it.

Moving across a level surface

Before moving the machine, properly secure the IV pole to its lower mount. Hold the IV pole below its upper mount as a handle to maintain control of the machine. Push the machine from the middle when moving it.

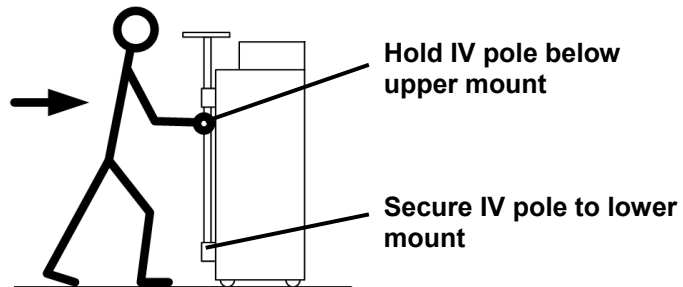

Moving over a ¾ inch threshold

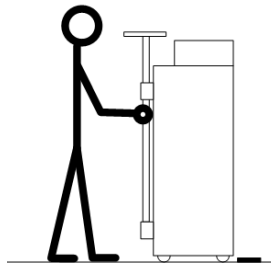

1. Stop machine at threshold.

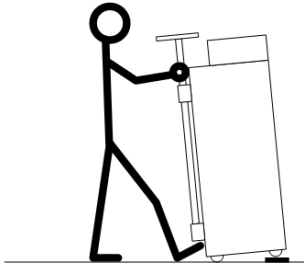

2. Brace foot against base. Use IV pole to raise forward wheels onto threshold. Do not tip machine too far back!

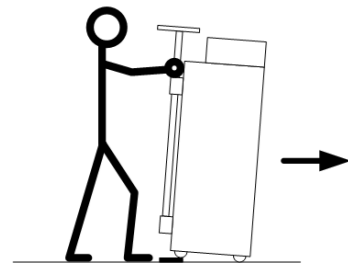

3. Push machine slowly over threshold. Keep firm hold on IV pole.

Moving down a 1 ½ inch step

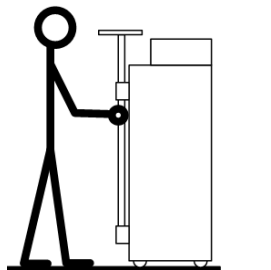

1. Stop machine at step.

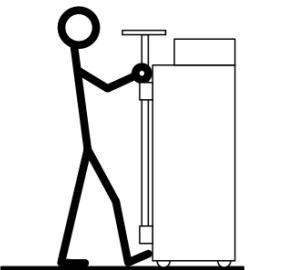

2. Brace foot against base. Hold IV pole above upper mount.

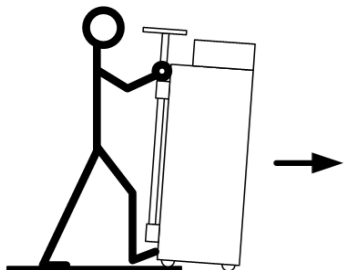

3. Slowly lower machine down step. Keep firm hold on IV pole. Do not tip machine too far forward!

Figure 21 – Moving the 2008T Hemodialysis Machine

Chapter 2

Daily Preparation for Treatment

This chapter provides the qualified operator with the recommended daily procedures for preparing the 2008T hemodialysis machine for regular hemodialysis operation.

To prepare the 2008T hemodialysis machine for Sustained Low Efficiency Dialysis (SLED), see Appendix B on page 293.

Covered here are the initial tasks that are to be performed before the patient is connected to the extracorporeal blood circuit. These tasks are not patient-specific, and are broken down into three categories:

- Setting up the dialysis delivery system
- Preparing the extracorporeal blood circuit
- Conducting pressure and alarm tests

Starting Point

The following is a checklist of conditions that should exist after installation of the 2008T hemodialysis machine by a qualified technician. Before beginning the daily preparation procedures, visually inspect the machine to verify that:

- ✓ The water supply line is connected to the water inlet and the water is turned on.
- ✓ The machine's drain line is inserted into a drain with an air gap.
- ✓ The power cord is plugged into a grounded, GFI-protected wall socket, and the main power switch located on the back of the machine is in the ON position.
- ✓ The heater switch is in the ON position.
- ✓ The acid/acetate suction line (red connector) is inserted into the red, acid/acetate, rinse port.
- ✓ The bicarbonate suction line (blue connector) is inserted into the blue, bicarbonate, rinse port.
- ✓ If the machine has the optional bibag connector, check that the bibag door is firmly closed
- ✓ The dialyzer supply line (blue connector) and dialyzer return line (red connector) are inserted into the matching-color connectors of the shunt interlock.
- ✓ The machine has been recently disinfected and rinsed, and is ready for use.
- ✓ Ensure the emergency hand crank for the blood pump is available.

If any of the conditions listed vary from those found on the machine, correct them before continuing with the daily preparation procedure.

Preparing the Dialysis Delivery System

There are two ways to prepare the 2008T hemodialysis machine for a treatment: the standard, manual setup method or the Auto Start method (functional software version 2.72 or later with 2008T BlueStar™ Premium). For instructions on using the Auto Start method to automatically set up the machine and begin testing without assistance from the operator, see page 57. To prepare the 2008T hemodialysis machine using the standard, manual method, see below.



Note: If the display screen is off and the Status Light flashes green, the machine is in Low Power Mode. To turn the display back on, simply touch the touchscreen, keyboard, or touchpad. If these are unresponsive, press the **Reset** key to exit Low Power Mode. For more information about Low Power Mode, see 341.

Note: If the machine is filled with disinfectant or Rinse is the only option that appears in the “Select Program” screen, the machine must complete a rinse cycle before being used for treatment. Select **Rinse** to start the rinse cycle. Upon completion of rinse cycle test the machine for any residual disinfectant according to the established guidelines of the facility.

Note: During the power up sequence a message is displayed for a few seconds: “Press Confirm for Service Mode”. If this is done, the machine enters the calibration screens instead of the “Select Program” screen.

Note: The “Select Program” screen displays any additional software applications (Apps) that are installed on the 2008T hemodialysis machine (see Figure 22 for an example).

Manual Machine Setup

To manually prepare the 2008T hemodialysis machine for operation:

1. Press the **POWER** key on the control panel. The “Select Program” screen (see Figure 22) will appear on the monitor after approximately one minute.



Note: If the message “Low Volume Mode Set!” is displayed on the “Select Program” screen and the current treatment will be for a patient weighing over 40 kg, be sure to set the ‘Low Volume’ option on the “Test & Options” screen to ‘Off’ before inserting the PatientCard.

2. Flip down the touchpad located below the Control Panel Keypad.

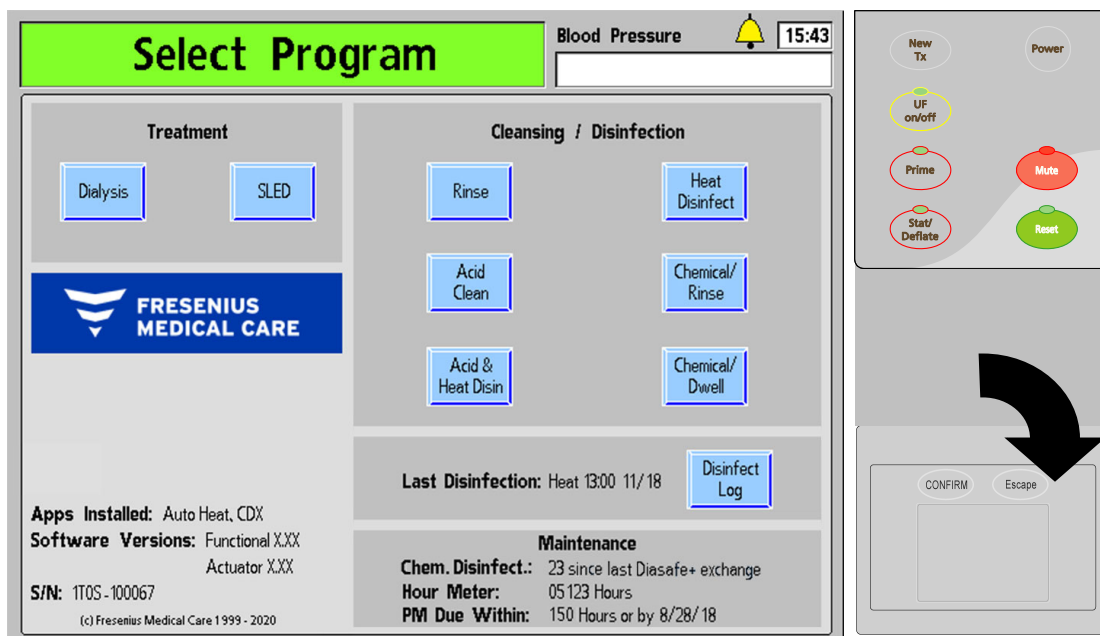

Figure 22 – The Select Program Screen (functional software version 2.81 or later) and Touchpad



Note: If the *bi*bag disposable is the bicarbonate source, do not pull the blue bicarbonate connector from the machine’s rinse port. Do the following to prepare the *bi*bag disposable:

- a) Remove the plastic seal from underneath the water and bicarbonate nozzles of the *bi*bag disposable.
- b) Open the *bi*bag door on the machine by lifting up on the dark-gray handle.
- c) With the white *bi*bag handle facing outward, hang the *bi*bag disposable on the *bi*bag connector nozzles. Push it down until it is fully seated on the *bi*bag connector nozzles.
- d) Close the door, making sure it latches firmly in place. An audible click means the door is closed.

Note: The *bi*bag disposable must hang freely below the *bi*bag connector. Make certain that there are no jugs or other objects obstructing or touching the *bi*bag disposable.

3. Insert the acid concentrate (red) connector into a centralized acid supply or a jug containing sufficient acid concentrate for an entire treatment. If acetate concentrate is being used, insert the red connector into the acetate supply.



Caution: Be sure the jug contains enough concentrate for the entire treatment. If the jug runs out during treatment, a condition known as “air lock” may occur, causing conductivity problems.

4. If the machine is being prepared for normal dialysis: select the **Dialysis** button on the display screen by highlighting the button with the touchpad and either tapping or pressing the **CONFIRM** key. The “Dialysate” screen will appear on the monitor (see Figure 23). (The optional touchscreen can be used by touching the **Dialysis** button directly.)

If the machine is being prepared for Sustained Low Efficiency Dialysis (SLED), select the **SLED** button instead. For more information on SLED, see Appendix B on page 293.

- Verify that the concentrate type, displayed near the top of the screen, correctly matches the prescribed concentrate type, and that the acid/bicarbonate or acetate concentrates connected to the machine match the type selected. If an incorrect concentrate type is displayed, the correct concentrate must be entered. To change the concentrate selection, see “Setting an Acid/Bicarbonate Type” on page 88.



Note: The machine will not allow usage of the *bi*bag disposable unless the 45x concentrate type is selected in Service Mode.

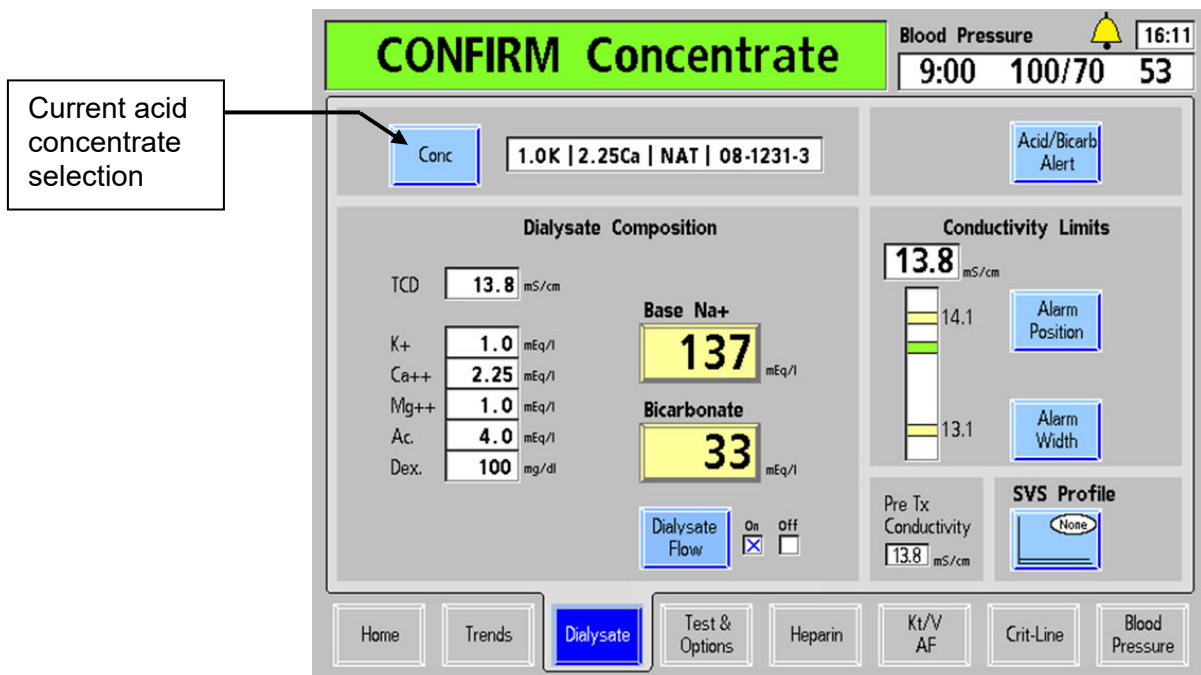

Figure 23 – Confirming Concentrates on the Dialysate Screen (functional software version 2.81 or later)



Note: If the machine is set up for use with Citrasate, a ‘Citrate’ meter box will be displayed in the dialysate constituent list.

- After the concentrate displayed is correct, verify that the Base Na⁺ and Bicarbonate are as prescribed. Press the **CONFIRM** key, and then select the **Home** screen-button.
- If a liquid bicarbonate is to be used for the treatment, insert the bicarbonate concentrate (blue) connector into a central bicarbonate supply or a jug containing sufficient bicarbonate concentrate for an entire treatment. Again, be sure the jug contains enough concentrate for the entire treatment.



Note: If the dry bicarbonate powder in the *bi*bag disposable will instead be the bicarbonate source, do not pull the blue bicarbonate connector out of your machine’s bicarbonate port. Doing so will stop the flow to and from the *bi*bag disposable.

Note: Bicarbonate solution is not stable over time. Make a fresh batch for each treatment according to the manufacturer’s instructions.



Note: Dialysate flow must be ON in order to fill the *bi*bag disposable with heated water.

Note: The *bi*bag disposable contains a fixed volume of bicarbonate powder. Refer to the run time tables on page 313 to verify that enough run time (including any set-up time and potential pre-treatment delays) is available to complete a treatment using one bag.

When the machine is ready (water at minimum temperature and no air in the hydraulics), it will begin mixing the concentrates. During this time, the message “**Stabilizing Dialysate**” will be displayed in the Status Box and the machine will not be ready for testing until this message clears. Or, if a *bi*bag disposable is connected, the machine will then fill the bag with heated water to be used as a bicarbonate concentrate for dialysate production. The machine’s conductivity and temperature readings should stabilize within ten minutes.

While the 2008T hemodialysis machine is preparing the dialysate, the bloodlines may be set up. Turn to page 60 for instructions on preparing the extracorporeal blood circuit.

Auto Start Machine Setup

The Auto Start method is a program that automatically powers on the 2008T hemodialysis machine at a scheduled time and, if the concentrates are connected, begins testing the machine to prepare it for stringing the bloodlines and running the final bloodline tests. If an Auto Start Rinse has been programmed (see page 345), ensure that the dialysate lines are on the shunt with the shunt door closed, the concentrate connectors are in their respective ports, no bibag is deployed and the bibag door is closed.

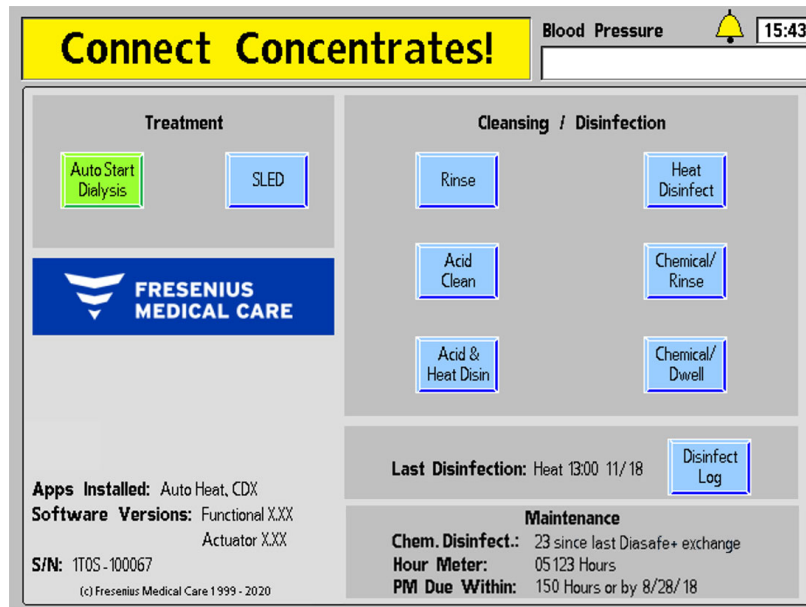

Figure 24 – The Auto Start Program Waiting for Concentrate Connection

To prepare the 2008T hemodialysis machine for Auto Start setup, the following conditions must also exist for the program to run:

- ✓ The Auto Start option has been set to run for the current treatment day (see page 345 for information on setting the Auto Start schedule and programming an Auto Start Rinse to precede Auto Start)
- ✓ The 2008T hemodialysis machine is either off, in Low Power Mode, or displaying the “Select Program” screen



Note: Auto Start does not cause the machine to exit Low Power Mode. To make the screen display visible, touch the touchscreen, keyboard, or touchpad.

- ✓ The red acid concentrate connector is inserted into a central acid supply or a jug containing sufficient acid concentrate for an entire treatment; if the connector is still in its port, the Auto Start Dialysis button will be green and the Status Box message “Connect Concentrates” will be displayed as in Figure 24 above. Once the connector is removed from its port, the machine will wait up to 10 minutes for dialysate conductivity and temperature to stabilize. If they do not, automatic testing will be cancelled and the self tests must be run manually.



Note: Both the acid and bicarbonate concentrate supplies must be connected to stabilize conductivity. Due to the 10-minute time limit, it is recommended to attach both acid and bicarbonate supplies at the same time. Follow clinic protocol and procedures.

- ✓ The bicarbonate source is connected:
- If a liquid bicarbonate is to be used: the blue bicarbonate concentrate connector is either inserted into a central bicarbonate supply or a jug containing sufficient bicarbonate concentrate for an entire treatment

Or

 - If the *bibag* disposable will instead be the bicarbonate source: the *bibag* disposable is connected to the *bibag* connector with the door closed and the blue bicarbonate concentrate connector is inserted in the blue, bicarbonate, rinse port



Note: If the *bibag* disposable is the bicarbonate source, do not pull the blue bicarbonate connector from the machine's rinse port. Do the following to prepare the *bibag* disposable:

- a) Remove the plastic seal from underneath the water and bicarbonate nozzles of the *bibag* disposable.
- b) Open the *bibag* door on the machine by lifting up on the dark-gray handle.
- c) With the white *bibag* handle facing outward, hang the *bibag* on the *bibag* connector nozzles. Push it down until it is fully seated on the *bibag* connector nozzles.
- d) Close the door, making sure it latches firmly in place. An audible click means the door is closed.

Note: The *bibag* disposable must hang freely below the *bibag* connector. Make certain that there are no jugs or other objects obstructing or touching the *bibag* disposable.

If any of the conditions listed vary from those found on the machine, correct them before running the Auto Start program.

When the scheduled Auto Start time occurs, the machine will automatically start the Dialysis program, confirm the concentrate, and, after the dialysate is prepared, run all of the listed self-tests. If there is an Air Detector Alarm, however, and Auto Prime is enabled, the Level Detector, Arterial Pressure, Venous Pressure and TMP tests will be skipped. They will run later during the Auto Prime program (if Auto Prime is disabled, no test will be skipped). At the beginning of the automatic self-test sequence, if no Air Detection Alarm occurs, the Status Box will display the message, “Standby for Test” until the tests begin (see Figure 25). Pressing keys or touching the touchscreen will interrupt the Auto Start testing.

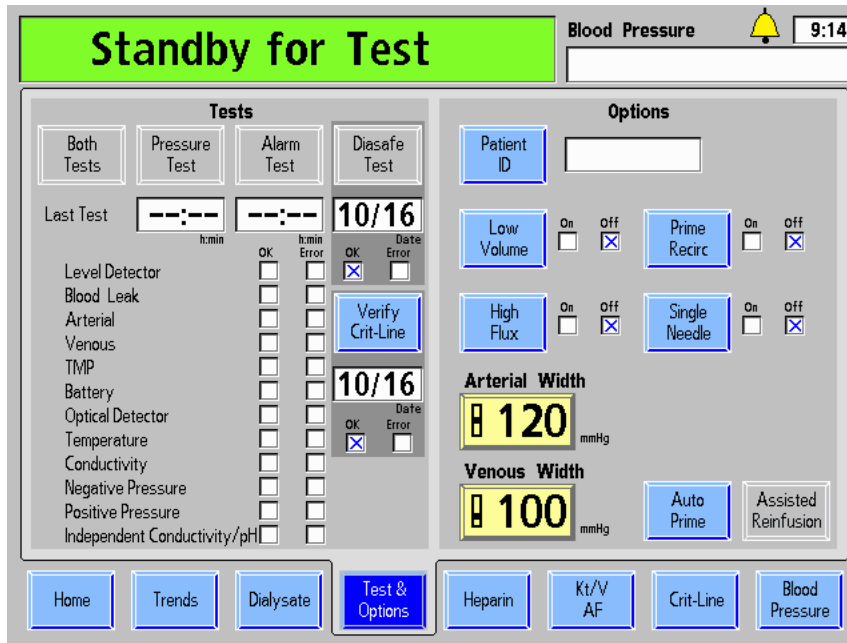

Figure 25 – Standby for Test



Note: On the “Test & Options” screen, a failure of any of the self-tests is indicated by a red X in the error box to the right of the test name. The right side of the screen provides additional information regarding the failure. A description of the test messages can be found in Chapter 6, “Troubleshooting”.

When the Auto Start self-tests have been successfully completed, the machine will display the message, “Auto Start: Complete” in the Status Box and the message, “Connect and prime bloodlines” in the Dialogue Box (see Figure 28). Press the **Reset** key to clear it and then follow the instructions on the next page to connect the bloodlines before priming.

Preparing the Extracorporeal Blood Circuit

Use Figure 26 or Figure 27, depending on the configuration of your machine, as a guide for connecting the bloodlines. The red lines on the machine are guides for arterial bloodline (from patient to dialyzer). The blue lines on the machine are guides for the venous bloodline (from the dialyzer to the patient). Be sure to use aseptic technique for all bloodline connections.



Note: To prepare the 208T hemodialysis machine for single-needle dialysis, see “Single Needle Dialysis” in Appendix A.

Note: The Post-pump arterial chamber configuration is incompatible with the Auto Prime and Assisted Reinfusion options.

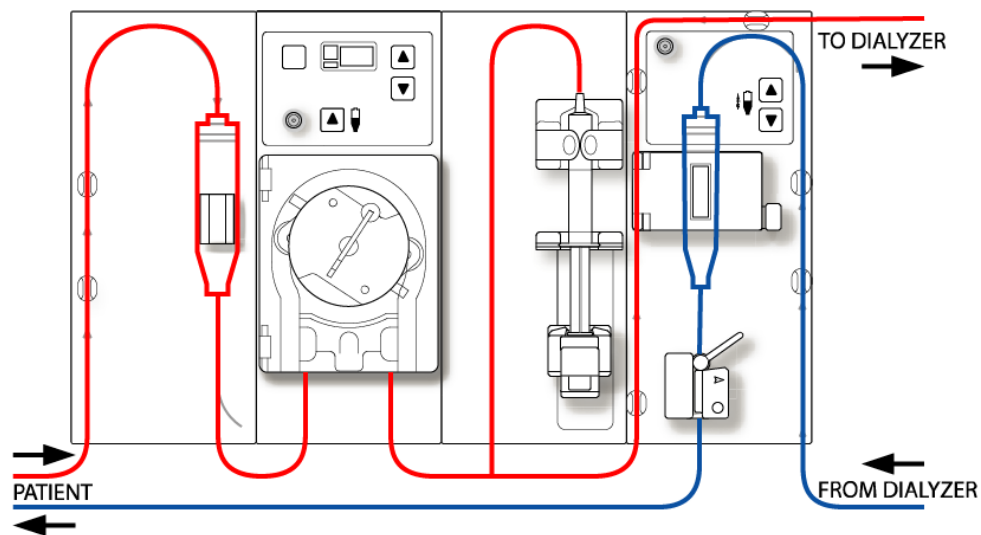

Figure 26 – Pre-pump Arterial Chamber Configuration

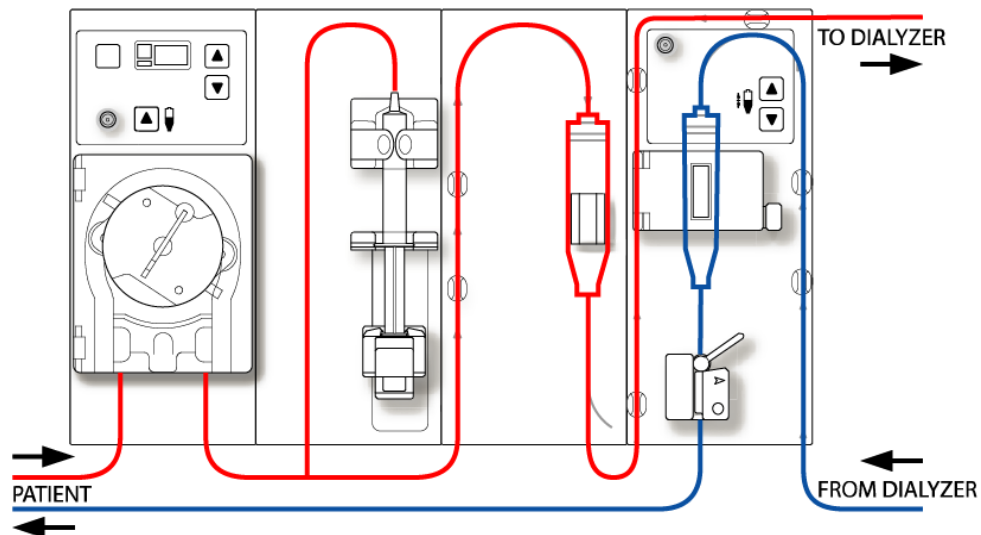

Figure 27 – Post-pump Arterial Chamber Configuration

Connecting the Extracorporeal Blood Circuit

For the following set of instructions, refer to Figure 13 – The Blood Pump Module on page 41 and Figure 15 – The Level Detector Module on page 43 regarding the names of the various module parts.

To connect the bloodlines:



Warning! Use aseptic technique.



Note: These are general instructions are for a new, dry-pack dialyzer. Your specific procedure should be consistent with the dialyzer manufacturer's instructions.

Arterial Bloodline Setup

1. Close medication port clamp.
 2. Snap the arterial chamber into its holder.
 3. Connect the arterial monitor line to the arterial pressure port using a transducer protector and verify that the monitor line is unclamped.
-



Warning! Transducer protectors should be used between transducers and each pressure monitor line of the extracorporeal system to prevent the transducers from getting wet. Wet transducer protectors must be replaced, as they will cause inaccurate pressure readings. If the external transducer protector and the internal transducer should become contaminated with blood, the transducer protectors **must** be replaced, and the transducer must be disinfected or replaced.

4. Open the blood pump door.
-



Warning! Inspect the blood pump rotor for proper operation (tubing guide posts not bent, rollers move freely, crank lever moves freely). Bent or loose tubing guide posts can damage bloodlines. Replace rotor if necessary. See page 184 for rotor diagram.

5. If necessary, set the pump for the diameter of the blood pump segment:
 - Press the Up (▲) and Down (▼) keys on the blood pump module simultaneously. The display will flash.
 - Press the Up (▲) or Down (▼) key on the blood pump module until the diameter of the pump segment being used is displayed.
 6. Load the blood pump segment:
 - a. Press and hold the **Start/Stop** key on the blood pump module to align rotor for line insertion.
 - b. Grasp the pump segment and, using thumb pressure, position it behind the left yoke by pressing the tubing retainer inward. Be sure the end of the segment clears the bottom of the yoke.
-



Warning! Make sure the collar of the pump segment is positioned below the bottom of the yoke. This will minimize the possibility of the segment kinking during pump operation.

Warning! Keep fingers free of rotor while it is turning to avoid possible injury.

- c. Press and hold the **Start/Stop** key. The rotor will rotate to the 5 o'clock position and stop. Relieve pressure on the retainer and release the segment. The beginning of the pump segment should be secured between the left yoke and the tubing retainer.

- d. Press and hold the **Start/Stop** key again and the rotor will rotate one full turn to automatically position the remainder of the segment within the pump housing. After loading, any extra pump segment tubing length should be on the right side of the pump.
 - e. Release the **Start/Stop** key when the pump segment has been inserted along the track inside the pump housing all the way to the right yoke.
 - f. Grasp the remaining portion of the segment and, using thumb pressure in a manner similar to step b, position it behind the right yoke.
 - g. Release the tubing retainer and close the pump door. Be sure the pump segment is free of kinks and both ends of the segment extend below the yoke.
7. Snap remaining arterial tubing in the clips along the red guidelines shown on modules.
 8. Aseptically place the patient end of the arterial line into the priming bucket clip. Snap the dialyzer end of the arterial bloodline into the dialyzer holder clip.



Warning! Do not allow the ends to touch the fluid in the bucket to prevent contamination.

Venous Bloodline Setup

1. Close medication port clamp.
2. Open the level detector door and roll the venous drip chamber into its holder with the filter below the sensor heads and the line on the chamber above the door. Close and latch the door.



Warning! The level detector must be calibrated to the venous line model being used.

Warning! If the venous chamber contains a filter, be sure the filter portion of the chamber is positioned below the ultrasonic sensor heads of the drip chamber holder.

3. Connect the venous pressure monitor line to the pressure port. Be sure to insert a transducer protector between the line and the port. Verify that the monitor line is unclamped.



Warning! Transducer protectors should be used between transducers and each pressure monitor line of the extracorporeal system to prevent the transducers from getting wet. Wet transducer protectors must be replaced, as they will cause inaccurate pressure readings. If the external transducer protector and the internal transducer should become contaminated with blood, the transducer protectors **must** be replaced, and the transducer must be disinfected or replaced.

4. Snap remaining venous tubing in the clips along the blue guidelines shown on modules (do not insert the venous bloodline into the venous clamp yet).
5. Snap the dialyzer end of the venous bloodline into the dialyzer holder clip.
6. Aseptically place the patient end of the venous line into the priming bucket clip.



Warning! Do not allow the ends to touch the fluid in the bucket to prevent contamination.

Dialyzer Setup

1. Mount the dialyzer in its holder, arterial-end up.
2. If the CLiC device will be used for this treatment, connect the Crit-Line Blood Chamber to the dialyzer's arterial port at this time. For more information, see the *2008T Hemodialysis Machine with CLiC User's Guide* (P/N 490206).

Priming the Blood Circuit

There are three different ways to prime the bloodlines on the 2008T hemodialysis machine: Standard Prime, Prime Amount, and Auto Prime (functional software version 2.72 or later with 2008T BlueStar Premium).

- The Standard Prime method allows the operator to prime the blood circuit by controlling the flow of the saline manually. Continue below to use the Standard Prime method.
- The Prime Amount method is a machine option that is set in the Service Mode, and limits the amount of saline used in the priming procedure to a preset volume. Turn to page 64 to use the Prime Amount method.
- The Auto Prime method aids the operator in automatically priming the bloodlines and running the bloodline self-tests. This method can be used after the machine has been automatically started using the Auto Start program (see page 57) but can also be used after the Auto Start portion of the self-tests have passed for subsequent treatments. Turn to page 66 to use the Auto Prime method.

Prime the blood circuit according to how your machine was set up. Follow your unit protocol or dialyzer manufacturer's instructions for priming and rinsing dialyzers.



Warning! Use aseptic technique.

Standard Prime Method

1. Connect the dialyzer end of the arterial bloodline to the arterial port of the dialyzer. Rotate the dialyzer to the arterial end down position.
2. Connect the dialyzer end of the venous bloodline to the venous port of the dialyzer.
3. Insert the venous line in the venous line clamp and the optical detector. Close the optical detector door.



Warning! The tubing beneath the venous drip chamber must be inserted into the venous line clamp and the optical detector.

4. Hang a saline bag and attach an administration line, if not already attached, to the saline port on the arterial bloodline. Aseptically spike the saline bag.
5. Gravity prime the patient end of the arterial bloodline below the saline “T” with saline. When primed, clamp the patient end of the arterial bloodline.
6. If the heparin pump is to be used: connect the heparin syringe, prime the heparin line with heparin, and load heparin syringe into heparin pump. If the heparin pump is not used, clamp the heparin line.

7. On the control panel keypad, press the **Prime** key.
8. Press the blood pump **Start/Stop** key and run the blood pump at a rate of 150 ml/min. Adjust the flow rate by pressing the ▲ (up) or ▼ (down) keys.
9. Fill the arterial drip chamber to an acceptable level using the ▲ key (level adjust) on the blood pump. Close the arterial pressure monitor line clamp and disconnect the line from the arterial pressure port so the port is open to atmosphere.



Warning! The ▲ Level Adjust key on the Blood Pump module can only be used to raise the level in the arterial chamber. Do not press the **Level Adjust** key so long that the pressure transducer protector becomes wet. Wet transducer protectors must be replaced to avoid erroneous pressure readings.

10. Run the blood pump to flush saline through the circuit until a fluid level is detected in the venous drip chamber. The blood pump will stop when the level detector senses a level of fluid or two minutes have elapsed, whichever comes first.
11. Press the **Reset** key on the control panel to restart the blood pump and continue flushing saline through the blood circuit in accordance with established facility protocol regarding dialyzer rinsing.
12. After the required saline amount has passed through the circuit, press the **Start/Stop** key on the blood pump to stop the pump.
13. Clamp the patient end of the venous bloodline.
14. Adjust the fluid levels in the drip chambers by pressing the appropriate ▲ or ▼ level adjust keys. Close the venous pressure monitor line clamp and disconnect the monitor line from the venous pressure port so the port is open to atmosphere.
15. Aseptically connect the patient end of the arterial bloodline to the patient end of the venous bloodline using a sterile recirculation piece. Unclamp both lines.
16. Set the blood pump rate to 350-400 ml/min. Press the blood pump **Start/Stop** key to start the pump and begin recirculation. If necessary, press the **Reset** key to clear any alarms.
17. Ensure that the extracorporeal circuit is free of air bubbles.

Next, turn to page 72 to run the self-tests and finish connecting the bloodlines.

Prime Amount Method

1. Connect the dialyzer end of the arterial bloodline to the arterial port of the dialyzer. Rotate the dialyzer to the arterial end down position.
2. Connect the dialyzer end of the venous bloodline to the venous port of the dialyzer.
3. Hang a saline bag and attach an administration line, if not already attached, to the saline port on the arterial bloodline. Aseptically spike the saline bag.

4. Gravity prime the patient end of the arterial bloodline below the saline “T” with saline. When primed, clamp off the patient end of the arterial bloodline.
5. If the heparin pump is to be used: connect the heparin syringe, prime the heparin line with heparin, and load heparin syringe into heparin pump. If the heparin pump is not used, clamp the heparin line.
6. On the control panel keypad, press the **Prime** key.
7. Press the blood pump **Start/Stop** key and run the blood pump at a rate of 150 ml/min. Adjust the flow rate by pressing the ▲ (up) or ▼ (down) keys.
8. Fill the arterial drip chamber to an acceptable level using the ▲ key (level adjust) key on the blood pump. Close the arterial pressure monitor line clamp and disconnect the line from the arterial pressure port so the port is open to atmosphere.



Warning! The ▲ Level Adjust key on the Blood Pump module can only be used to raise the level in the arterial chamber. Do not press the **Level Adjust** key so long that the pressure transducer protector becomes wet. Wet transducer protectors must be replaced to avoid erroneous pressure readings.

9. The blood pump will start and continue to run until the pre-set amount of saline has been flushed through the circuit. When blood pump stops, clamp the patient end of the venous bloodline.
10. Insert the venous bloodline into the venous line clamp and optical detector on the level detector module. Close the optical detector door.



Warning! The tubing beneath the venous drip chamber must be inserted into the venous line clamp and the optical detector.

11. Adjust the fluid levels in the drip chambers by pressing the appropriate level adjust keys. Close the venous pressure monitor line clamp and disconnect the monitor line from the venous pressure port so the port is open to atmosphere.
12. Aseptically connect the patient end of the arterial bloodline to the patient end of the venous bloodline using a sterile recirculation piece. Unclamp both lines.
13. Set the blood pump rate to 350-400 ml/min. Press the blood pump **Start/Stop** key to start the pump and begin recirculation. If necessary, press the **Reset** key to clear any alarms.
14. Ensure that the extracorporeal circuit is free of air bubbles.

Next, turn to page 72 to run the self-tests and finish connecting the bloodlines.

Auto Prime Method with Auto Start Self-Tests Already Run

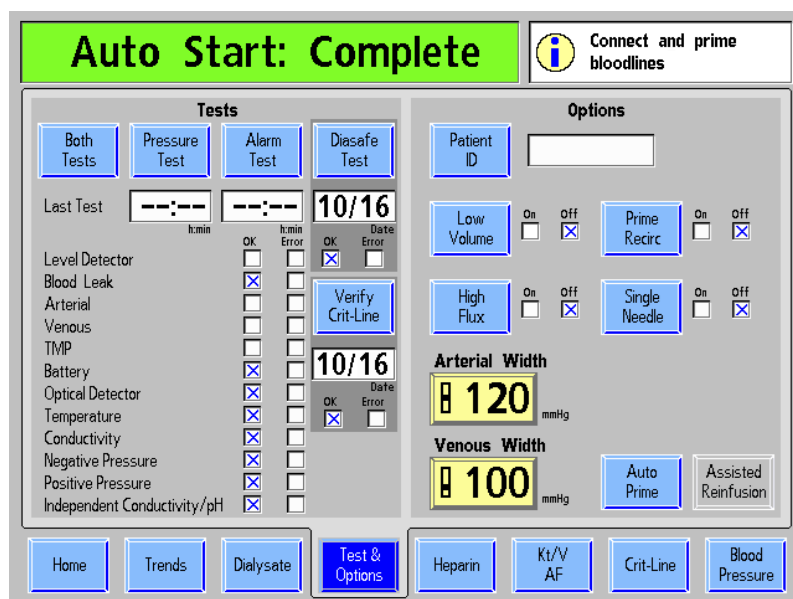

Figure 28 – Auto Prime Button on the Test & Options Screen with Auto Start program

If the ‘Auto Prime’ option is set in Service Mode, the **Auto Prime** button is displayed on the “Test & Options” screen. This button is available when the Tx Clock is paused and no blood is sensed and is used to aid the operator in automatically priming the bloodlines after the Auto Start portion of the self-tests have been run (with the exception of the Level Detector, Arterial, Venous, and TMP self-tests). If the Independent Conductivity test is shown at the end of the test list, the conductivity has also been independently verified by the machine and the independent conductivity reading is displayed on the “Dialysate” screen under the heading “Pre Tx conductivity” (see Table 11 on page 83 for more information). If a *bi*bag disposable is the bicarbonate source, the conductivity and approximate pH have already been independently verified by the Independent Conductivity/pH test.

To begin priming the bloodlines using the Auto Prime method, select the **Auto Prime** button, listen for the beep, and continue on to the next page.



Warning! After selecting and confirming the **Auto Prime** button, the machine will beep. As a test of the audible alarm system, make certain that the sound occurs. If the machine fails this or any of the Pressure, Alarm, and Diasafe tests and the cause cannot be corrected, or if it fails subsequent tests, it should not be used for treatment. Remove the machine from service and have it inspected by a qualified technician to correct the problem.



Note: This feature completes the remainder of the automatic testing performed during the Auto Start program. If the Auto Start program’s self-tests were not run, both the Alarm and Pressure tests must be run before using Auto Prime; turn to page 72 to first run the self-tests.

Note: The Auto Prime feature is disabled when the ‘Single Needle’ option is set.



Note: This procedure is shown using CombiSet® bloodlines (P/N 03-2722-9) and a new, dry-pack dialyzer; if a different bloodline set is used, the clinic is responsible for providing instructions.

Note: If the dialyzer requires more saline than is programmed as the default ‘Prime Amount’ in Service Mode, follow clinic protocol to resolve the issue.

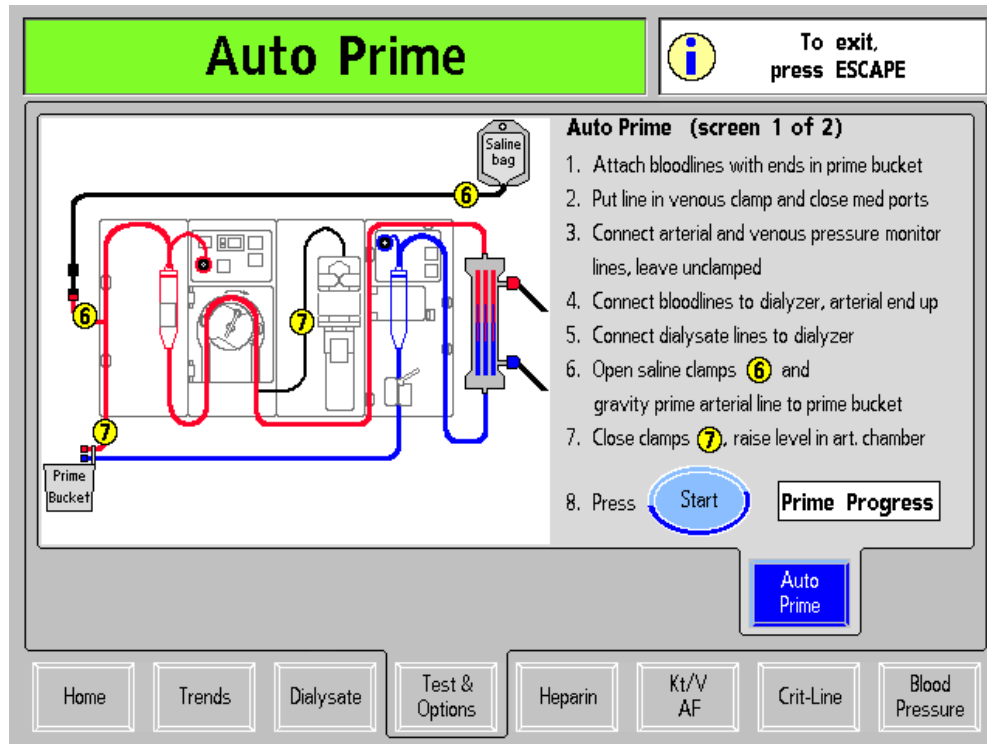

Figure 29 – First Auto Prime Screen

After selecting the **Auto Prime** button, the first “Auto Prime” screen is displayed (see above). Follow the on-screen instructions to prime the bloodlines before treatment:



Note: Pressing the **Escape** key will cancel priming and exit the “Auto Prime” screens and display the “Test & Options” screen.

1. Attach bloodlines with ends in prime bucket

Follow the on-screen diagram to snap the drip chambers into their holders and aseptically place the patient ends of the bloodlines into the priming bucket clip. Make sure the line on the venous drip chamber is positioned above the Level Detector door to prevent the transducer protectors from getting wet. Snap the dialyzer ends of the bloodlines into the bloodline holders on the dialyzer holder.



Warning! Do not allow the ends to touch the fluid in the bucket to prevent contamination.

2. Put line in venous clamp and close med ports

Ensure the venous bloodline is inserted into the venous line clamp below the optical detector. Close the clamps on the medication ports on each of the drip chambers.



Warning! The tubing beneath the venous drip chamber must be inserted into the venous line clamp and the optical detector.

3. Connect arterial and venous pressure monitor lines, leave unclamped

The arterial and venous pressure monitor lines must be unclamped and connected to their pressure ports.

4. Connect bloodlines to dialyzer, arterial end up

Connect the arterial and venous bloodlines to the dialyzer with the red, arterial bloodline at the top of the dialyzer.

5. Connect dialysate lines to dialyzer

With the bloodlines already connected as shown in the on-screen diagram, connect the dialysate lines to the dialyzer. Pull on the dialyzer connectors to make sure they are firmly connected to the dialyzer and close the shunt door afterward.



Note: All dialyzer connectors must be fastened tightly to prevent air from entering the dialysate circuit or to prevent dialysate from leaking from the dialyzer.

6. Open saline clamps **6 and gravity prime arterial line to prime bucket**

Open the saline port clamp on the arterial bloodline then gravity prime the patient end of the arterial bloodline below the saline “T” with saline.

7. Close clamps **7, raise level in art. chamber**

When the arterial bloodline below the saline “T” is primed with saline, close the clamp at the patient end of the arterial bloodline and close the heparin line clamp. Use the ▲ key (level adjust) on the blood pump to set the arterial drip chamber to an acceptable level if necessary.

8. Press Start button to prime

Press the **Start** button to automatically start the blood pump and run saline through the bloodlines. The **Start** button will be grayed-out during priming. When the Prime Progress bar graph reaches 100%, the next set of instructions will be displayed to recirculate the saline, see the next page. In software versions 2.81 and later, the bar will progress to 100% twice before the next screen appears.

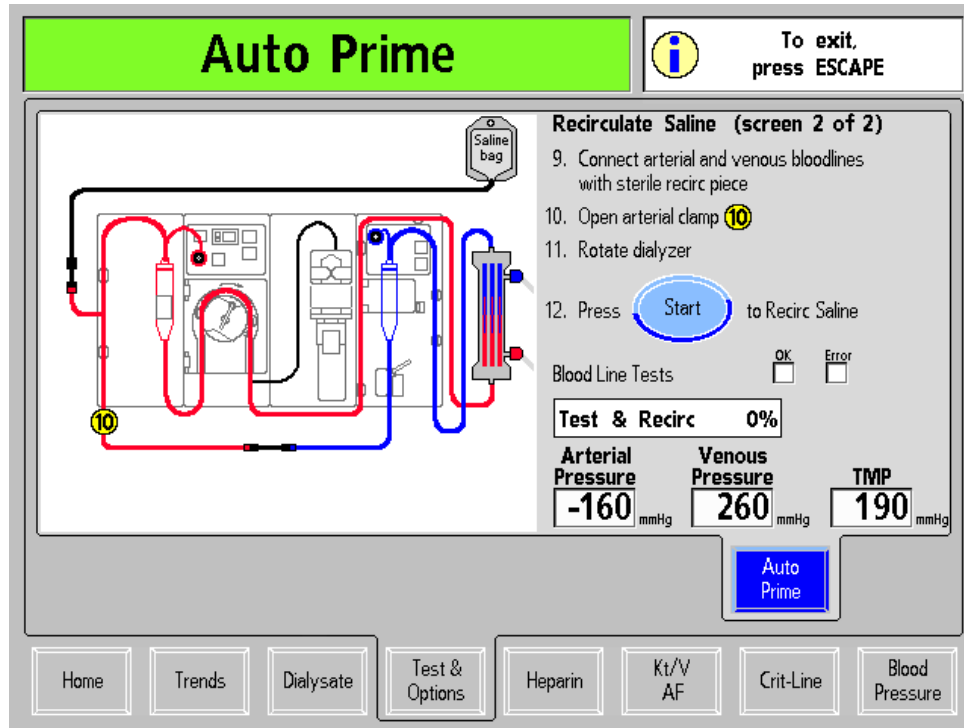

Figure 30 – Second Auto Prime Screen: Recirculate Saline

Follow the on-screen instructions to recirculate saline in the bloodlines before treatment:

9. Connect arterial and venous bloodlines with sterile recirc piece

Aseptically connect the patient end of the arterial bloodline to the patient end of the venous bloodline using a sterile recirculation piece as shown in the diagram.

10. Open arterial clamp 10

Open the clamp at the patient end of the arterial bloodline.

11. Rotate dialyzer

Rotate the dialyzer to venous end up to clear the remaining air out of the dialyzer. The Auto Prime method requires the dialyzer to be flipped only once during setup and the treatment can be run with the dialyzer venous end up if desired.

12. Press Start button to Recirc Saline

Press the **Start** button to start the blood pump and recirculate the saline. The bloodline test will begin, followed by the saline recirculation program. A bar graph will fill to show the progress of the test and recirculation program. The **Start** button will be grayed-out as the test runs.



Note: The recirculation time depends on the Recirc Goal and Recirc Time settings in Service Mode.

When the Test & Recirc bar graph shows 100%, the machine will display the message, “Auto Prime Complete, Press Confirm” in the Dialogue Box. Press the **CONFIRM** key to exit this screen and view the “Test & Options” screen (see next page).

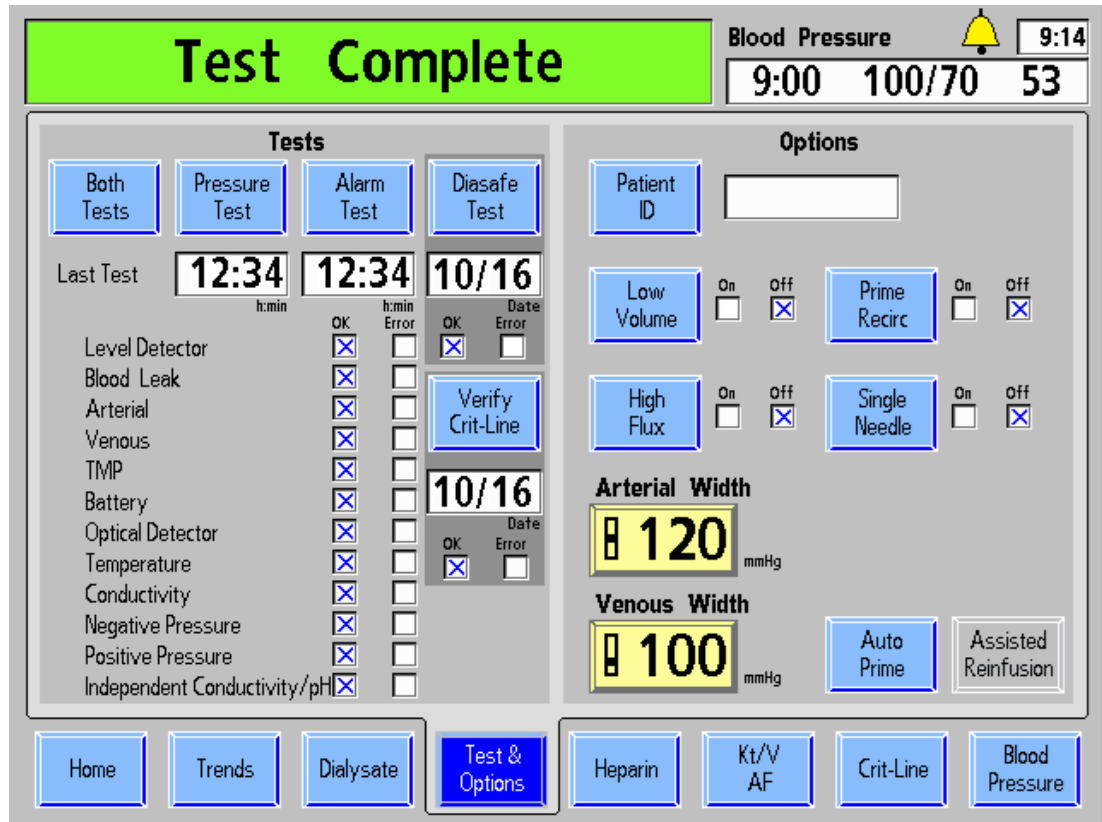

Figure 31 – Test & Options Screen with Independent Conductivity/pH and all tests complete

The “Test & Options” screen will display all the completed tests. The message “Test Complete” will be displayed in the Status Box. Press the **RESET** key to clear the message. For more information on reviewing test results on the “Test & Options” screen, see page 73.



Note: If the Pressure and Alarm tests have not been successfully completed, select the **Both Tests** button to run the remaining tests.

Continue on the next page to perform the final setup of the machine before entering the treatment parameters.

Final Setup when using Auto Prime Method

At this point, all self-tests should have been successfully completed and the saline should be recirculating in the bloodlines. If the ‘Independent Conductivity’ test (functional software version 2.72 or later with 2008T BlueStar Premium) was run as part of the self-tests and a *bibag* disposable is the bicarbonate source, the conductivity and approximate pH have already been independently verified by the Independent Conductivity/pH test.

- If the Independent Conductivity self-test was successfully completed but a *bibag* disposable is not the bicarbonate source, check the dialysate’s pH level.
- If the Independent Conductivity self-test is not listed in the self-tests on the “Test & Options” screen, check the dialysate’s conductivity and pH level.



Warning! Always verify the conductivity and approximate pH of the dialysate solution through independent means before initiating each dialysis treatment. Independent means could be by using an external conductivity meter, pH meter, pH paper or by using the machine’s independent conductivity test. An approximate pH check is also part of the machine’s independent conductivity test when a *bibag* disposable is connected. Verify that the conductivity is within 0.4 mS/cm of the theoretical conductivity value (TCD) and the pH is between 6.9 and 7.6 if using a pH meter or pH paper. If conductivity and pH are not within these limits, do not initiate dialysis. The machine’s independent conductivity test relies on the use of prequalified manufactured acid concentrates or verified batch concentrates; the pH check relies on the use of these concentrates and the *bibag*. For more information on collecting a dialysate sample for external testing, see “Testing the Dialysate” on page 359.

Continue below with the final setup steps:

1. Check blood tubing to ensure that there are no kinks, especially between the blood pump and the dialyzer.



Warning! Check all bloodlines for kinking. Improper blood flow may cause hemolysis of the blood.

2. Replace the saline bag with a fresh bag if necessary.
3. Check for a normal dialysate flow by observing the rise and fall of the external flow indicator located on the dialyzer supply line. The float should drop four times in about 15 seconds for a 500 ml/min flow, or four times in 10 seconds for an 800-ml/min flow.
4. Open the shunt door and verify that the machine goes into bypass mode. In bypass mode, the float in the flow indicator of the dialyzer supply line should drop and remain at the bottom of the indicator and an audible alarm may sound.



Note: The 2008T hemodialysis machine can be configured (in Service Mode) so that audible alarms occur only when the optical detector senses blood. If this option is not selected, an audible alarm will sound when the shunt interlock door is open.

Next, turn to page 77 to enter the treatment parameters and prepare to connect the patient to the machine for treatment.

Testing the 2008T Hemodialysis Machine

Before beginning treatment, the 2008T hemodialysis machine should undergo Pressure and Alarm tests to ensure that it is functioning properly. There are four different ways to run self-tests for the machine:

- If the machine has been automatically started up using the Auto Start program and the Auto Prime program (functional software version 2.72 or later with 2008T BlueStar Premium) has been completed, then all testing has already been automatically run; turn to page 77 to enter the treatment parameters and prepare to connect the patient to the machine for treatment.
- If the bloodlines have not been primed yet, the majority of self-tests can be run before selecting the Auto Prime program (during which the remaining four self-tests will be completed). Select the **Both Tests** button in the “Test & Options” screen to run the Auto Start self-tests before priming then turn to page 66 to run the Auto Prime program.
- If the Auto Start program has been run but Auto Prime is not desired, then four alarm self-tests remain: the Level Detector, Arterial Pressure, Venous Pressure, and TMP self-tests (see below). Select either the **Both Tests** or the **Alarm Test** button to complete the remaining self-tests. Turn to page 75 to perform the final setup procedure.
- If the machine has not been automatically started up using the Auto Start program and the bloodlines have already been primed, all pressure and alarm tests must be run at this time. Select the **Both Tests** button in the “Test & Options” screen to start the test, see below:



Note: The 2008T hemodialysis machine can be configured so that this testing is mandatory after power up with the Service Mode ‘Forced Test’ option selected (see page 315 for more information). In this case, the test will start on its own shortly after the operator powers the machine on.

To run the test sequence using the **Both Tests**, **Alarm Test**, or **Pressure Test** button,

- The dialyzer lines must be connected to the shunt with the interlock door closed.
- The machine must be in an alarm-free condition by allowing sufficient time for the dialysate to reach proper conductivity and temperature. This takes about five minutes from the time the concentrate is confirmed on the “Dialysate” screen (see Figure 23 on page 55).
- Arterial and venous monitor lines must be clamped and removed from the pressure monitor ports so the monitor ports are open to atmosphere.
- UF and SVS must be off.



Warning! It is essential that the 2008T hemodialysis machine’s balancing system is operating properly. The machine must successfully complete a Pressure test before each treatment, especially when using high-flux dialyzers.



Note: If the Service Mode ‘Independent Cond Test’ option is enabled (functional software version 2.72 or later), the Independent Conductivity self-test will be listed among the self-tests. Running this test will independently verify the conductivity of the dialysate. If the *bi*bag disposable is the bicarbonate source for the treatment, the Independent Conductivity/pH self-test will be listed and the machine will independently verify both the conductivity and pH of the dialysate. See page 322 for more information.

To run the Pressure and Alarm tests:

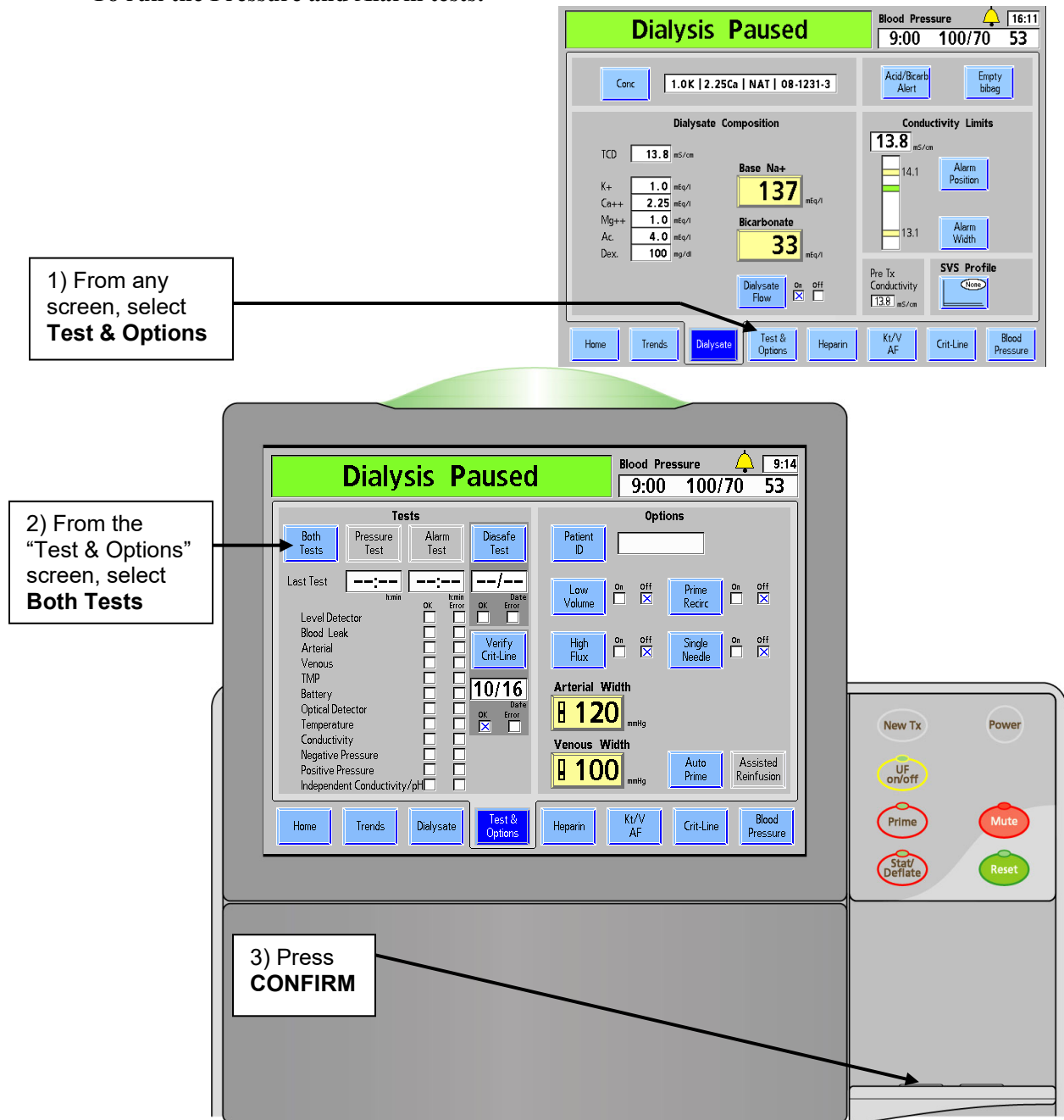

Figure 32 – Starting Automatic Tests (functional software version 2.81 or later with lines on shunt)

Test Sequence

The automated test sequence consists of two distinct parts—Alarm tests and Pressure Holding tests. The Pressure Holding Test, the Alarm test, or both tests can be started by selecting the corresponding button on the “Test & Options” screen and pressing the **CONFIRM** key on the touchpad. After a long power down, however, only the **Both Tests** button is enabled.

Individual tests are identified as shown on the “Test & Options” screen. A failure of any of the tests is indicated by a red X in the error box to the right of the test name.

The Alarm test consists of tests that verify the integrity of the settable alarm limits of the system. Both the alarm and pressure tests should be conducted by the operator prior to each treatment.

The Pressure Holding Test (PHT) consists of two separate tests that are conducted sequentially. The purpose of the PHT test is to ensure the pressure integrity of the hydraulic system under actual pressures generated during the normal operation of the system. PHT must be performed before each high-flux treatment.

If all tests are completed successfully, a message “Test Complete” appears in the Status Box. The operator must press **Reset** once to clear the message. Patient-specific treatment parameters (other than UF related) can be entered at any time during the test.

An audible alarm sounds only if a test has failed. In a failure situation, after all of the tests have been completed, the message “Test Failed,” “Alarm Test Failed,” or “Pressure Test Failed” is displayed in the Status Box depending on the nature of the failure. A red X appears in the Error box designating the test(s) failed. The right side of the screen provides additional information regarding the failure. A description of the test messages can be found in Chapter 6, “Troubleshooting”. Pressing the **Reset** key once mutes an alarm; pressing it a second time resets the right side of the screen.

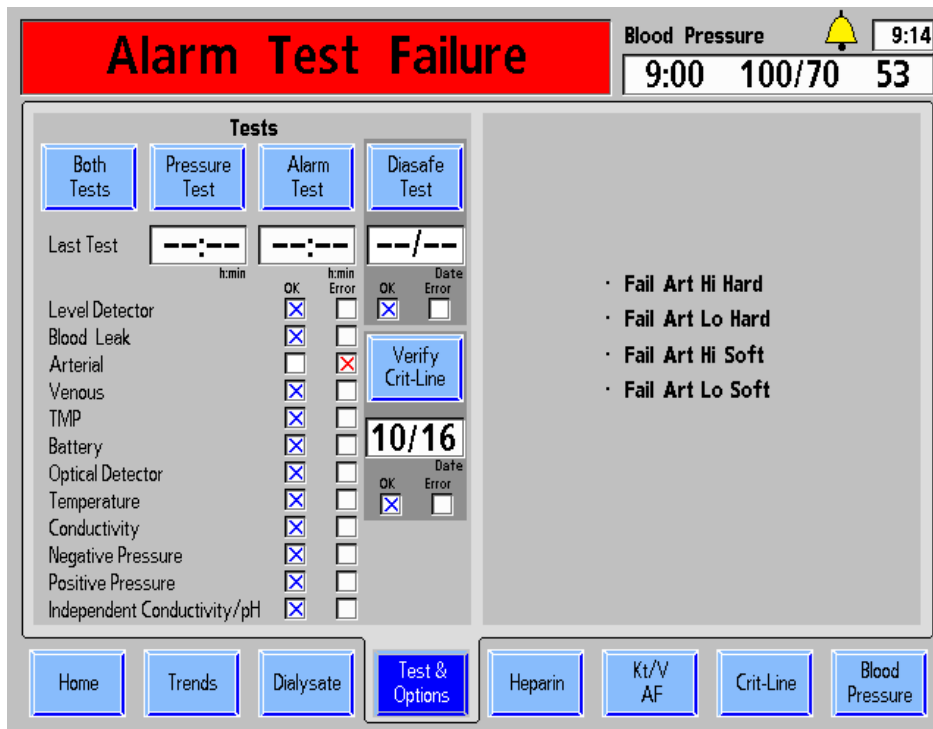

Figure 33 – Test Failure Screen (showing functional software version 2.72 or later with 2008T BlueStar Premium)



Warning! After selecting and confirming a test button, the machine will beep. As a test of the audible alarm system, make certain that the sound occurs. If the machine fails this or any of the Pressure, Alarm, and Diasafe tests and the cause cannot be corrected, or if it fails subsequent tests, do not use it for treatment. Remove the machine from service and have it inspected by a qualified technician to correct the problem.

The 2008T hemodialysis machine can be set up to perform online PHTs during treatment. These tests routinely happen every 12 minutes, and check the integrity of the hydraulic system. In the event of a failure, an alarm sounds and a message is displayed in the Status Box. For more information see “Online Pressure Holding Test” on page 165.

Recirculation and Final Set-Up Procedure

If the Auto Prime program (functional software version 2.72 or later with 2008T BlueStar Premium) has been successfully completed, then all setup and testing is complete. Turn to page 77 to enter the treatment parameters and prepare to connect the patient to the machine for treatment.

If the 2008T hemodialysis machine has been set-up using the Standard Prime or Prime Amount methods, the following steps must still be performed:

1. Rotate dialyzer to arterial inlet up.
2. Check the conductivity and pH of the dialysate. If the optional ‘Independent Conductivity Test’ (see page 72 for more information) is enabled, the dialysate conductivity has already been independently verified and the reading is displayed on the “Dialysate” screen. If a *bibag* disposable is the bicarbonate source for the treatment, the pH has also been independently confirmed as a result of this test. If using a reuse dialyzer, test for residual disinfectant before connecting the dialysate lines to the dialyzer. For more information on collecting a dialysate sample for external testing, see “Testing the Dialysate” on page 359.



Warning! Always verify the conductivity and approximate pH of the dialysate solution through independent means before initiating each dialysis treatment. Independent means could be by using an external conductivity meter, pH meter, pH paper or by using the machine’s independent conductivity test. An approximate pH check is also part of the machine’s independent conductivity test when a *bibag* disposable is connected. Verify that the conductivity within 0.4 mS/cm of the theoretical conductivity value (TCD) and the pH is between 6.9 and 7.6 if using a pH meter or pH paper. If conductivity and pH are not within these limits, do not initiate dialysis. The machine’s independent conductivity test relies on the use of prequalified manufactured acid concentrates or verified batch concentrates; the pH check relies on the use of these concentrates and the *bibag*. For more information on collecting a dialysate sample for external testing, see “Testing the Dialysate” on page 359.



Note: If 1.5x or 2x dialysate flow (Auto Flow) is selected, be sure that the dialysate flow rate is at least the minimum required rate (depending on facility procedure and manufacturer’s instructions).

3. Connect dialysate lines to dialyzer by matching the color of the dialyzer connector to the color of the blood tube fitting and then close the shunt door. When done correctly, the red arterial blood tubing connector and the red dialyzer connector of the dialysate line should be connected to the corresponding ports at the top of the dialyzer. This is to create a counter-current flow (blood flowing from top to bottom, dialysate flowing from bottom to top) inside the dialyzer to maximize clearance.
4. Pull on the dialyzer connectors to make sure they are firmly connected to the dialyzer.



Note: All dialyzer connectors must be fastened tightly to prevent air from entering the dialysate circuit or to prevent dialysate from leaking from the dialyzer.

5. Reconnect arterial and venous monitor lines to their respective ports. Unclamp the lines.
6. When the dialysate compartment is filled, rotate the dialyzer so the arterial inlet is down.
7. After priming the extracorporeal blood circuit, press **Reset** to clear all alarms. Set the blood pump rate to 350-400 ml/min and start the blood pump to begin recirculating the saline through the circuit.
8. Press the ▼ (down) key on the Level Detector module to lower the fluid level in the drip chamber. Verify that the blood pump stops and the venous clamp occludes.



Warning! The test of the level detector system must be run as a precaution and aid to identifying potential failures. Remove the machine from service if it fails this test.

9. Press the ▲ (up) key on the Level Detector module to raise the fluid level in the drip chamber to an acceptable level.
10. Check blood tubing to ensure that there are no kinks, especially between the blood pump and the dialyzer.



Warning! Check all bloodlines for kinking. Improper blood flow may cause hemolysis of the blood.

Warning! If using a dialyzer that has been stored in a liquid disinfectant such as formaldehyde, test the recirculating saline solution for residual disinfectant according to established facility protocol or the manufacturer's instructions. Special rinsing techniques must also be employed to assure the concentration of disinfectant is reduced and maintained at an appropriate level. These rinsing procedures are the responsibility of the medical director. The procedure must include a test for residual disinfectant and techniques to avoid rebound of the disinfectant. Turning the dialysate flow off when using a reused dialyzer may allow the chemical disinfectant to rebound (increase) to an unacceptable level.

11. Replace saline bag with a fresh bag if necessary.
12. Check for a normal dialysate flow by observing the rise and fall of the external flow indicator located on the dialyzer supply line. The float should drop four times in about 15 seconds for a 500 ml/min flow, or four times in 10 seconds for an 800-ml/min flow.
13. Open the shunt door and verify that the machine goes into bypass mode. In bypass mode, the float in the flow indicator of the dialyzer supply line should drop and remain at the bottom of the indicator and an audible alarm may sound.



Note: The 2008T hemodialysis machine can be configured (in Service Mode) so that audible alarms occur only when the optical detector senses blood. If this option is not selected, an audible alarm will sound when the shunt interlock door is open.

Next, turn to page 77 to enter the treatment parameters and connect the patient to the machine for treatment.

Setting Treatment Parameters

This chapter instructs the patient care specialist on the procedures for entering patient-specific treatment parameters. The procedures for preparing the machine for daily use, in Chapter 2, must be completed prior to setting treatment parameters.

Before proceeding, be sure that:

- ✓ The machine has passed the alarm and pressure tests.
- ✓ The dialysate is at the proper temperature, conductivity, and pH.
- ✓ The dialysate has been tested and found free of residual disinfectant.

The treatment parameters can be entered in a variety of ways: screen-by-screen entry (see page 78), using the “Default Parameters” screen, or using the PatientCard to automatically download them to the 2008T hemodialysis machine.

- The “Default Parameters” screen is available by pressing and confirming the **New Tx** key when the Service Mode ‘Default Rx Screen’ option is set to ‘Yes’ (functional software version 2.72 or later), see page 119 to continue.
- To use the PatientCard and “Prescription” screen (using functional software version 2.72 or later), turn to page 126 to continue.



Warning! Do not connect a patient to the machine or attempt to set treatment parameters until these conditions have been met.

Warning! The values shown in pictures here are for example only. Parameters must be entered as prescribed by the patient’s physician. Failure to enter correct parameters could result in serious injury or death.

Recommended Order for Screen-by-Screen Entry

The process of setting patient-specific treatment parameters screen-by-screen should be done in a specific order. The table below lists the order the screens should be opened, and parameter to set in each of them.

- **Dialysate Screen**—Access the Sodium and Bicarbonate level of the dialysate and display the constituent concentration as prescribed by the physician.
- **Home Screen**—Access the UF and Sodium Variation System (SVS) parameters, dialysate flow, dialysate temperature, display conductivity, and later, start the treatment.
- **Test & Options Screen**—Settings to perform single-needle or Low Volume dialysis or use high-flux dialyzers are activated in this screen. The patient ID (if applicable) is also entered here.
- **Heparin Screen**—Set the parameters for administering heparin.
- **Kt/V AF Screen**—Set the parameters for the Kt/V display and run the Access Flow measurement.
- **BTM/BVM Screen or Crit-Line Screen**—If applicable, set the BTM and BVM or Crit-Line[®] parameters.
- **Blood Pressure Screen**—Set pressure and interval settings to facilitate taking pulse and blood pressure readings automatically.

Before entering treatment parameters, the existing parameters and settings should be reverted to their defaults. This is done using the **New Tx** key, continue to the next page.

New Treatment Key

When the 2008T hemodialysis machine is first turned on in preparation for daily operation (after a long power down), all treatment parameters revert to their default settings. This can also be accomplished by pressing the **New Tx** (New Treatment) key when in Dialysis/SLED. The **New Tx** key allows the operator to reset patient treatment parameters to their default settings without interrupting the power to the machine. If the PatientCard is not used, the **New Tx** key should be used to prepare the 2008T hemodialysis machine for each treatment.

After pressing and confirming the **New Tx** key or after a long power down:

- All treatment data (blood pressure, Kt/V, Patient ID) are deleted. The treatment summary information is moved to the previous record in the “Trends” screen.
- Crit-Line/BVM settings are reset to default values
- The RTD counter is reset to zero
- All heparin treatment parameters are reset to zero
- SVS profile is reset to None
- UF treatment parameters are reset as follows:
 - UF profile is reset to None
 - UF Removed is reset to zero
 - UF Goal = 3000
 - UF Time = 3:00
 - UF Rate = 1000
- The “Dialysate” screen is displayed and the concentrate will need to be confirmed



Note: If the Service Mode ‘New Tx Rx Warning’ (New Treatment Prescription Warning) option is enabled (functional software version 2.72 or later), resetting the treatment using the **New Tx** key will display pop-up windows if the Base Na⁺ and Bicarbonate values do not match the nominal concentrate settings. The operator must then confirm the values are not nominal. See page 328 for more information. This option is disabled when using the PatientCard.

When the Service Mode ‘Default Rx Screen’ option is set to ‘Yes’ (functional software version 2.72 or later), pressing and confirming the **New Tx** key will display the “Default Parameters” screen where the operator may conveniently access most treatment parameters in one place, see page 119 for more information.

To activate the New Treatment Option:

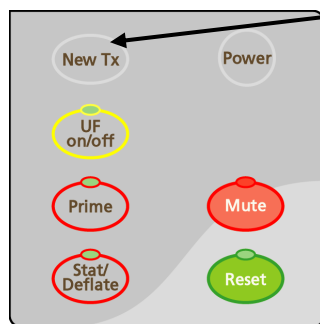
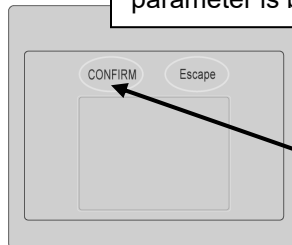

Figure 34 – New Tx key

1) Press the **New Tx** key.
Note: When pressing the **New Tx** key, the cursor will disappear because a new parameter is being entered.



2) Press **CONFIRM** or press **Escape** to cancel.
Note: Pressing **CONFIRM** or **Escape** will cause the cursor to reappear.

Entering a Treatment Parameter

Treatment parameters can be entered quickly and easily using the keyboard, touchpad, and touchscreen. All editable treatment data are displayed in yellow rectangular buttons in the treatment screens (for a description of the different types of buttons, see page 32). To change a treatment parameter in any screen, highlight the parameter to change by selecting the corresponding button on the display screen. The selected button changes to a brighter shade of yellow when highlighted. Enter the new value using the numbers or **↑** / **↓** (up or down) keys located on the keyboard. After entering the new value, press the **CONFIRM** key to save it in the 2008T hemodialysis machine's memory. The following example illustrates this procedure.

To set a treatment parameter:

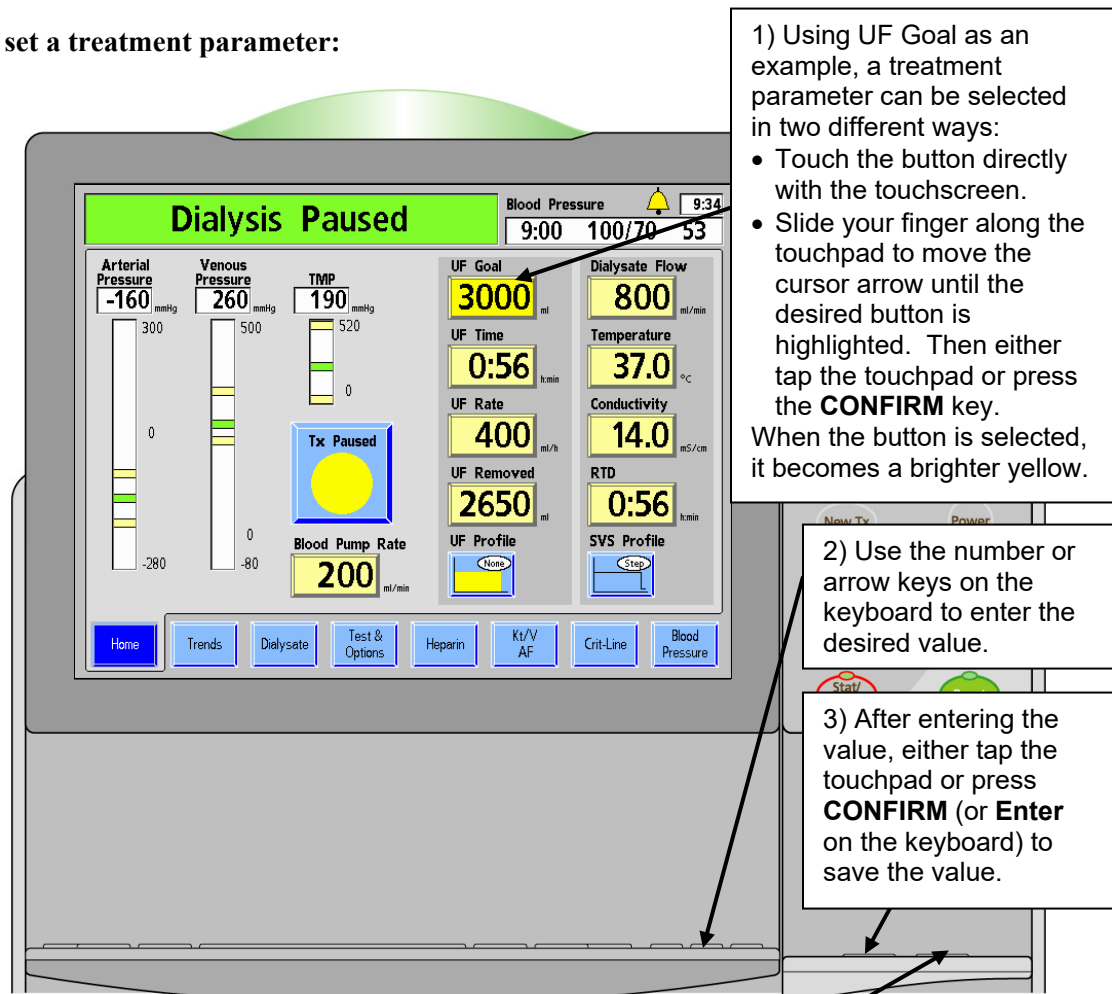

Note: If an incorrect parameter value was entered, press the **Escape** key on the touchpad or the **Esc** key on the keyboard to cancel. You can only cancel an entry before the **CONFIRM** key has been pressed. If a parameter value entry has been confirmed, follow steps 1 - 3 to re-enter the correct parameter value.

Figure 35 – Entering Treatment Parameters

An operator may attempt to enter data that is invalid. Some examples are:

- Attempting to enter a time of 1:80. The time format is hours:minutes. Anything over 59 minutes is not valid.
- Attempting to enter a time of 0:62. Until the **CONFIRM** key or another parameter entry button is selected, this is allowed because the operator may be intending to enter 6:20, which is valid.
- Attempting to enter a value that is above or below the allowed range of a parameter entry box. For instance, entering a Na⁺ value above 155 mEq/l is not allowed and therefore is an invalid entry.

When the **↑** / **↓** (up or down) keys are used to enter a value, the scrolling will stop at the upper or lower allowed values. If the operator enters an invalid time with the numbers on the keyboard, a Dialogue Box message shows the erroneous value and explains to press the **Escape** key. If an invalid parameter other than time is entered, the value will be entered as the lowest or highest allowed value, accompanied with a message in the Dialogue Box.

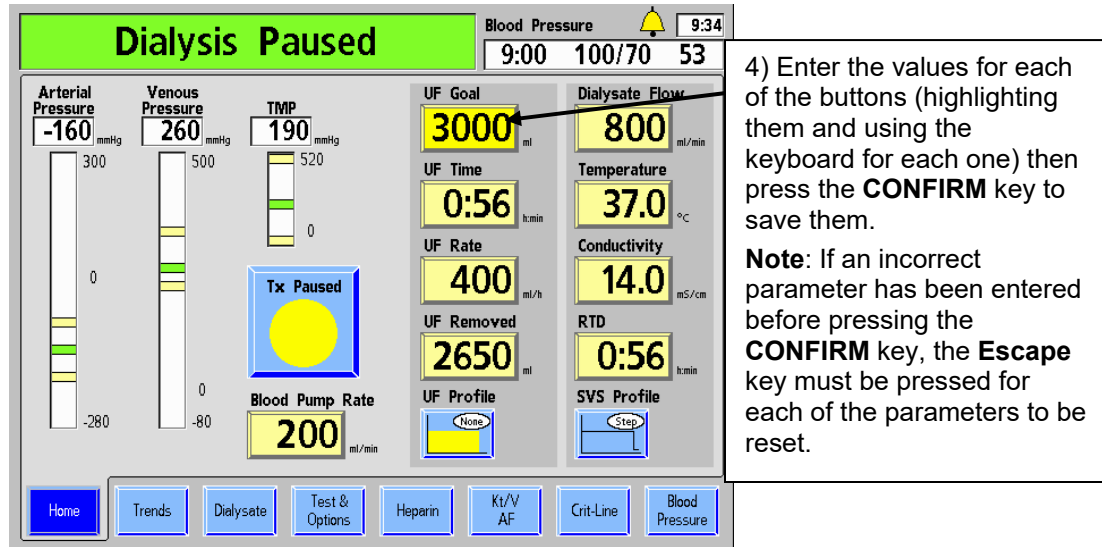

Figure 36 – Entering Parameters, continued

To set an option for the treatment:

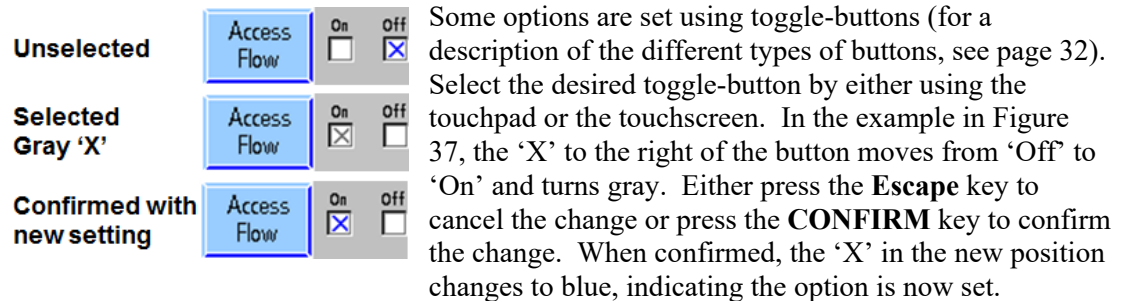

Figure 37 – Changing a toggle-button setting



Note: The on-screen cursor will disappear if not moved for five seconds. It also disappears when a value is entered but not yet confirmed. To display the cursor again the operator can do one of the following: tap the touchpad, press the **CONFIRM** or **Escape** key on the touchpad or press the **Enter** or **Esc** key on the keyboard.

Dialysate Screen Settings

The “Dialysate” screen is displayed automatically at start up. It is also shown when either the **Dialysate** button or **Conductivity** button in the “Home” screen is pressed.

Within the “Dialysate” screen, the concentrations of base sodium (Na^+), bicarbonate, and other constituents are displayed. The Theoretical Conductivity (TCD)—the conductivity of the dialysate based on these concentrations—is displayed in the left side of the screen. The actual conductivity of the dialysate is displayed on the right side, above the Conductivity bar graph.

Most dialysate or dialysate-related alarm parameters are accessed from the “Dialysate” screen. Unless otherwise described, enter or change a dialysate-related value by following the procedure described in “Entering a Parameter” on page 80.

What to do from this screen...

Enter the prescribed dialysate settings for:

- Concentrate type
- Base Na^+ level
- Bicarbonate level
- Sodium Variation (SVS) profile

Set Alarm limits for:

- Low Acid/Bicarbonate alert
- Position and width of Conductivity Alarm window

Turn Dialysate Flow on or off (functional software version 2.34 or later)

View the independent conductivity reading when dialysate lines are on the shunt



Warning! The specific acid and bicarbonate concentrates, including the sodium, bicarbonate, and electrolyte compositions, must be prescribed by a physician.



Warning! The values shown in pictures here are for example only. Parameters must be entered as prescribed by the patient’s physician. Failure to enter correct parameters could result in serious injury or death.



Note: If the machine is set up for use with Citrasate, a ‘Citrate’ meter box will be displayed in the dialysate constituent list.

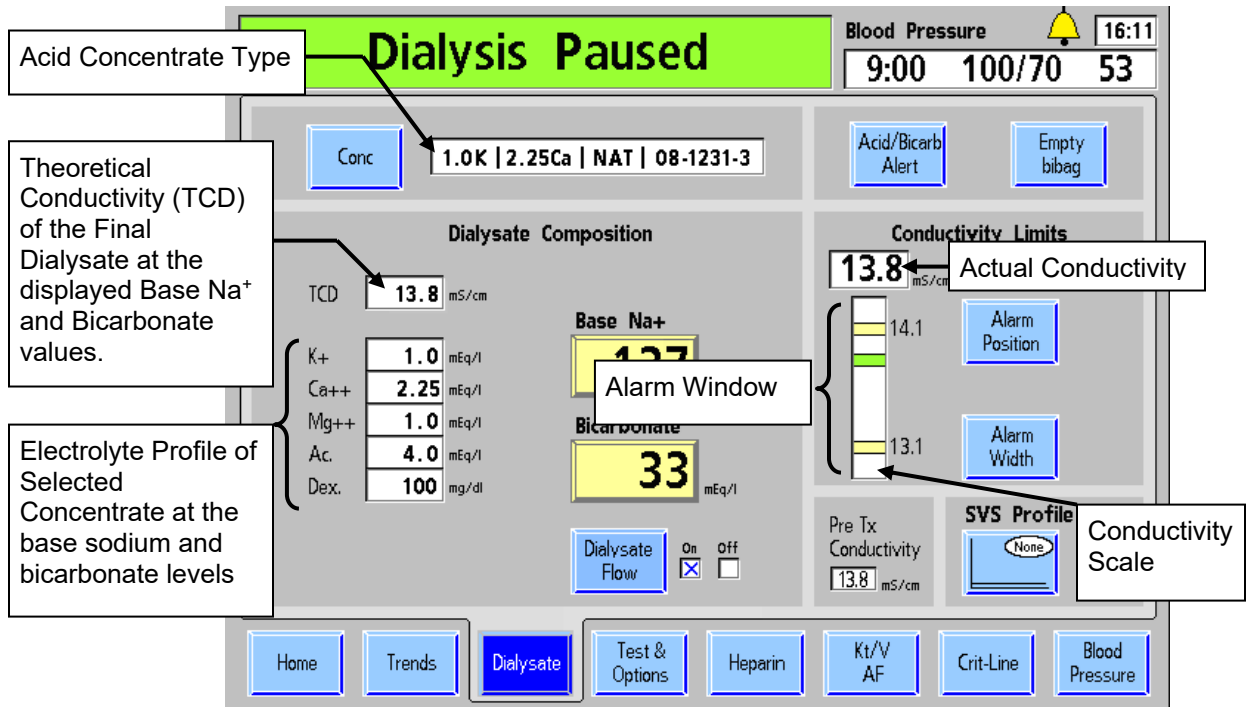
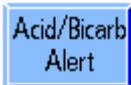



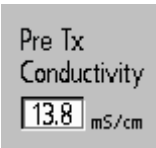



Figure 38 – The Dialysate Screen (functional software version 2.81 or later with lines on shunt)

The following table describes the features that are found in the “Dialysate” screen.

Table 11 – Dialysate Screen Features

Button	Function
	Concentrate —Selecting the Concentrate button opens a subscreen to allow for the selection of a concentrate type from a drop down menu. See “Figure 40 – Entering Concentrate Information” on page 89.
	Base Na⁺ —This is the prescribed base sodium (Na ⁺) that will be delivered to the dialyzer in the Final Dialysate (post proportioning and the reaction of the acid and bicarbonate concentrates). Selecting this button and using the ↑ or ↓ (up or down) keys on the keyboard, the operator can set the base sodium content of the dialysate in milliequivalents per liter (mEq/L). The values of some of the other constituents will change as this parameter is adjusted (see Table 12 on page 85 for more information).
	Bicarbonate —This is the prescribed bicarbonate that will be delivered to the dialyzer in the Final Dialysate (post proportioning and the reaction of the acid and bicarbonate concentrates). Selecting this button and using the ↑ or ↓ (up or down) keys on the keyboard, changes the bicarbonate level in milliequivalents per liter (mEq/L). The values of some of the other constituents will change as this parameter is adjusted (see Table 13 on page 86 for more information).
	Dialysate Flow On/Off —Selecting and confirming this toggle-button will turn off dialysate flow. The value displayed in the Dialysate Flow button on the “Home” screen will flash when dialysate flow is turned off with this toggle-button. Select and confirm this button again to resume dialysate flow at the previously set rate (functional software version 2.34 or later).

Button	Function
	<p>Acid/Bicarbonate Alert—Selecting this button opens a subscreen with options to notify the user when there is only 20 percent concentrate remaining in either supply jug. See “Setting the Acid/Bicarbonate Alert” on page 90.</p>
	<p>Empty bibag—At the end of a bibag-based treatment, a blue Empty bibag button is displayed in the upper right corner of the “Dialysate” screen to empty the bag for easy disposal (see page 177 for more information).</p>
	<p>Alarm Position—Selecting this button and using the \uparrow or \downarrow (up or down) keys on the keyboard, the operator can shift the conductivity alarm window, up or down in 0.1 mS/cm increments. The alarm window can be shifted 0.5 mS/cm above or below the TCD of the selected concentrate type within the maximum upper limit of 16.0 mS/cm, and the minimum lower limit of 12.5 mS/cm. For more information, see “Conductivity Limits” on page 91.</p> <p>If the Service Mode ‘Cond Alarm Position’ option is set to ‘Locked’, this button is un-selectable and the alarm position cannot be adjusted. See page 319 for more information.</p>
	<p>Alarm Width—Selecting this button and using the \uparrow or \downarrow (up or down) keys on the keyboard, the operator can change the width of the conductivity alarm window from 0.6 to 1.0 mS/cm width. For more information, see “Conductivity Limits” on page 91.</p>
	<p>Pre Tx Conductivity Reading (functional software version 2.72 or later)—This box appears only if the Service Mode ‘Independent Cond Test’ option is set to ‘Yes’. This reading is frozen after the self tests and will not change in the course of the treatment. The reading will not change until the start of self tests for the next treatment.</p>
<p>SVS Profile</p> 	<p>SVS Profile—This button, which also appears in the “Home” screen, opens the “Sodium Variation System (SVS) Profile” subscreen. For more information, see “Sodium Variation System” on page 103. This button is colored green when an SVS profile is running (functional software version 2.34 or later).</p> <p>If the SVS option is set to ‘No’ in Service Mode, this button will not be displayed.</p>

Final Dialysate Composition

Final Dialysate contains sodium, bicarbonate, and the minor dialysate constituents shown on the “Dialysate” screen. The 2008T hemodialysis machine maintains dialysate sodium and bicarbonate at the prescribed levels using a volumetric proportioning system. The conductivity of the dialysate is displayed and used to monitor, but not control, the Final Dialysate composition.

The dialysate constituents depend on the sodium and bicarbonate selections; they will change if either the sodium or bicarbonate selection changes. When the operator changes the prescribed bicarbonate (set in the **Bicarbonate** button), the acid stream also changes in order to keep the prescribed Final Dialysate sodium constant. Similarly, when the operator changes the prescribed sodium (set in the **Base Na⁺** button), the bicarbonate stream also changes in order to keep the prescribed Final Dialysate bicarbonate level constant.

The minor electrolyte constituents of potassium, calcium, and magnesium are part of the acid stream and will change from nominal settings when the bicarbonate or sodium is changed from nominal. For the NaturaLyte, GranuFlo, and Citrasate brand concentrates, Table 12 provides examples of how potassium, calcium, and magnesium are affected as the prescribed sodium changes, first from the nominal 137 mEq/L to the lowest limit of 130 mEq/L and then the highest limit of 155 mEq/L. These changes to the dialysate composition keep the prescribed Final Dialysate bicarbonate level constant.

Note: Because the exact minor electrolyte constituent values will vary depending on the Base Na⁺ and Bicarbonate values prescribed by the physician, actual values in the electrolyte profile on the “Dialysate” screen may not always exactly match the table in the acid concentrate package label.

Table 12 – Final Dialysate Ranges in mEq/L with Bicarbonate Constant at 33 mEq/L

NaturaLyte 2251-0 with 4 mEq/L Acetate							
Prescribed Sodium	Sodium	Bicarbonate	Potassium	Calcium	Magnesium	Acetate	Dextrose
137 mEq/L nominal setting	137	33	2.0	2.5	1.0	4.0	100
130 mEq/L lowest setting	130	33	1.9	2.3	0.9	3.7	93
155 mEq/L highest setting	155	33	2.3	2.9	1.2	4.7	117
GranuFlo 2251-3B with 8 mEq/L Acetate (4 mEq/L Acetic Acid + 4 mEq/L Sodium Acetate)							
Prescribed Sodium	Sodium	Bicarbonate	Potassium	Calcium	Magnesium	Acetate	Dextrose
137 mEq/L nominal setting	137	33	2.0	2.5	1.0	8.0	100
130 mEq/L lowest setting	130	33	1.9	2.3	0.9	7.5	93
155 mEq/L highest setting	155	33	2.3	2.9	1.2	9.4	117

Citrasate 2251-CA with 2.7 mEq/L Acetate (2.4 mEq/L Citrate + 0.3 mEq/L Acetate)								
Prescribed Sodium	Sodium	Bicarbonate	Potassium	Calcium	Magnesium	Citrate	Acetate	Dextrose
137 mEq/L nominal setting	137	34	2.0	2.5	1.0	2.4	0.3	100
130 mEq/L lowest setting	130	34	1.9	2.3	0.9	2.2	0.2	93
155 mEq/L highest setting	155	34	2.4	2.9	1.2	2.8	0.3	118

Table 13 below provides examples of how these same constituents are affected as the prescribed Final Dialysate bicarbonate instead changes, first from the nominal 33 mEq/L (34 mEq/L for Citrasate) to the lowest limit of 20 mEq/L and then the highest limit of 40 mEq/L. These changes to the dialysate composition keep the prescribed Final Dialysate sodium level constant.

Table 13 – Final Dialysate Ranges in mEq/L with Sodium Constant at 137 mEq/L

NaturaLyte 2251-0 with 4 mEq/L Acetate								
Prescribed Bicarbonate	Sodium	Bicarbonate	Potassium	Calcium	Magnesium	Acetate	Dextrose	
33 mEq/L nominal setting	137	33	2.0	2.5	1.0	4.0	100	
20 mEq/L lowest setting	137	20	2.3	2.8	1.1	4.5	113	
40 mEq/L highest setting	137	40	1.9	2.3	0.9	3.7	93	
GranuFlo 2251-3B with 8 mEq/L Acetate (4 mEq/L Acetic Acid + 4 mEq/L Sodium Acetate)								
Prescribed Bicarbonate	Sodium	Bicarbonate	Potassium	Calcium	Magnesium	Acetate	Dextrose	
33 mEq/L nominal setting	137	33	2.0	2.5	1.0	8.0	100	
20 mEq/L lowest setting	137	20	2.3	2.8	1.1	9.0	113	
40 mEq/L highest setting	137	40	1.9	2.3	0.9	7.5	93	
Citrasate 2251-CA with 2.7 mEq/L Acetate (2.4 mEq/L Citrate + 0.3 mEq/L Acetate)								
Prescribed Bicarbonate	Sodium	Bicarbonate	Potassium	Calcium	Magnesium	Citrate	Acetate	Dextrose
34 mEq/L nominal setting	137	34	2.0	2.5	1.0	2.4	0.3	100
20 mEq/L lowest setting	137	20	2.3	2.8	1.1	2.8	0.3	114
40 mEq/L highest setting	137	40	1.9	2.4	0.9	2.3	0.2	94

The following table shows the full extent of those changes to the electrolyte constituents in the Final Dialysate composition with sodium (Base Na⁺) at 137 mEq/L and post-reaction bicarbonate at 33 mEq/L (34 mEq/L for Citrasate), 20 mEq/L, and 40 mEq/L:

Table 14 – Example of “Dialysate” Screen Dialysate Composition Ranges with Sodium Constant at 137 mEq/L

Naturalyte®	GranuFlo®	Citrasate®
<p>Nominal Bicarbonate Setting</p> <p>Dialysis Paused Blood Pressure 9:00 100/70 53 16:37</p> <p>Conc 2.0K 2.5Ca NAT 08-2251-0</p> <p>Dialysate Composition: TCD 13.6, Base Na⁺ 137, Bicarbonate 33</p> <p>Conductivity Limits: 14.1, 13.1</p>	<p>Nominal Bicarbonate Setting</p> <p>Dialysis Paused Blood Pressure 9:00 100/70 53 16:19</p> <p>Conc 2.0K 2.5Ca GRA 0FD2251-3B</p> <p>Dialysate Composition: TCD 13.5, Base Na⁺ 137, Bicarbonate 33</p> <p>Conductivity Limits: 13.5, 13.0</p>	<p>Nominal Bicarbonate Setting</p> <p>Dialysis Paused Blood Pressure 9:00 100/70 53 15:09</p> <p>Conc 2.0K 2.5Ca CITL 08-2251-CA</p> <p>Dialysate Composition: TCD 13.7, Base Na⁺ 137, Bicarbonate 34</p> <p>Conductivity Limits: 13.7, 13.2</p>
<p>Minimum Bicarbonate Setting</p> <p>Dialysis Paused Blood Pressure 9:00 100/70 53 16:40</p> <p>Conc 2.0K 2.5Ca NAT 08-2251-0</p> <p>Dialysate Composition: TCD 14.1, Base Na⁺ 137, Bicarbonate 20</p> <p>Conductivity Limits: 14.6, 13.6</p>	<p>Minimum Bicarbonate Setting</p> <p>Dialysis Paused Blood Pressure 9:00 100/70 53 16:27</p> <p>Conc 2.0K 2.5Ca GRA 0FD2251-3B</p> <p>Dialysate Composition: TCD 13.9, Base Na⁺ 137, Bicarbonate 20</p> <p>Conductivity Limits: 14.4, 13.4</p>	<p>Minimum Bicarbonate Setting</p> <p>Dialysis Paused Blood Pressure 9:00 100/70 53 15:08</p> <p>Conc 2.0K 2.5Ca CITL 08-2251-CA</p> <p>Dialysate Composition: TCD 14.1, Base Na⁺ 137, Bicarbonate 20</p> <p>Conductivity Limits: 14.6, 13.6</p>
<p>Maximum Bicarbonate Setting</p> <p>Dialysis Paused Blood Pressure 9:00 100/70 53 16:43</p> <p>Conc 2.0K 2.5Ca NAT 08-2251-0</p> <p>Dialysate Composition: TCD 13.4, Base Na⁺ 137, Bicarbonate 40</p> <p>Conductivity Limits: 13.9, 12.9</p>	<p>Maximum Bicarbonate Setting</p> <p>Dialysis Paused Blood Pressure 9:00 100/70 53 16:31</p> <p>Conc 2.0K 2.5Ca GRA 0FD2251-3B</p> <p>Dialysate Composition: TCD 13.3, Base Na⁺ 137, Bicarbonate 40</p> <p>Conductivity Limits: 13.8, 12.8</p>	<p>Maximum Bicarbonate Setting</p> <p>Dialysis Paused Blood Pressure 9:00 100/70 53 15:21</p> <p>Conc 2.0K 2.5Ca CITL 08-2251-CA</p> <p>Dialysate Composition: TCD 13.4, Base Na⁺ 137, Bicarbonate 40</p> <p>Conductivity Limits: 13.9, 12.9</p>

Setting an Acid/Bicarbonate Type

Acid concentrates for use in Dialysis/SLED are selected ahead of time in Service Mode. The acid and bicarbonate concentrate types are paired together when setting dialysate parameters on the “Dialysate” screen. If the current patient’s prescribed dialysate differs from the previous patient’s, or if the machine is new or has been recalibrated, a new acid/bicarbonate concentrate type matching the dialysate prescribed by the current patient’s physician must be entered.

To enter the acid/bicarbonate concentrate type:

Dialysis Paused

Blood Pressure

16:11
9:00 100/70 53

Conc

1.0K | 2.25Ca | NAT | 08-1231-3

Acid/Bicarb Alert

Empty bibag

Dialysate Composition

TCD	13.8	mS/cm			
K+	1.0	mEq/l	137	mEq/l	
Ca ⁺⁺	2.25	mEq/l	33	mEq/l	
Mg ⁺⁺	1.0	mEq/l			
Ac.	4.0	mEq/l			
Dex.	100	mg/dl			

Dialysate Flow

On Off

Conductivity Limits

13.8

mS/cm

14.1

13.1

Alarm Position

Alarm Width

Pre Tx Conductivity

13.8 mS/cm

SVS Profile

None

Home
Trends
Dialysate
Test & Options
Heparin
Kt/V AF
Crit-Line
Blood Pressure

1) From the “Dialysate” screen, select the **Conc** button. The “Concentrate” subscreen opens.

Figure 39 – Enter Acid & Bicarbonate Type

1) The electrolyte profile of the highlighted selection is displayed in this column.
Note: If the machine is set up for use with Citrasate a 'Citrate' meter box will be displayed in the dialysate constituent list.

2) Highlight the desired selection by scrolling through the choices using the \uparrow or \downarrow (up or down) keys on the keyboard.

3) When the desired type is highlighted, press the **Enter** key or **CONFIRM** key on the Touchpad to save the selection and return to the "Dialysate" screen.
Note: Be sure the acid/bicarbonate concentrates connected to the machine match the type selected from the Concentrate menu.

4) Enter the prescribed Base Na+ and Bicarbonate values as described in "Entering a Treatment Parameter" on page 80.

Dialysis Paused | Blood Pressure 11:02 | 9:00 100/70 53

Conc 1.0K | 2.25Ca | NAT | 08-1231-3

Select Concentrate
 use Up and Down keys to scroll

- 3.0K | 2.5 Ca | CITL | 08-3251-CA
- 2.0K | 2.25Ca | GRA | OFD2231-3B
- 1.0K | 2.25Ca | NAT | 08-1231-3
- 2.0K | 2.25Ca | CITL | OFD2231-DA

Na+ 100.0 mEq/l
 K+ 1.0 mEq/l
 Ca++ 2.25 mEq/l
 Mg++ 1.0 mEq/l
 Ac. 4.0 mEq/l
 Dex. 100 mg/dl

Home Trends Dialysate Test & Options Heparin Kt/V AF Crit-Line Blood Pressure

CONFIRM Escape

Dialysis Paused | Blood Pressure 16:11 | 9:00 100/70 53

Conc 1.0K | 2.25Ca | NAT | 08-1231-3

Acid/Bicarb Alert Empty bibag

Dialysate Composition

CD 13.8 mS/cm

Base Na+ 137 mEq/l

Bicarbonate 33 mEq/l

Dialysate Flow On off

Conductivity Limits

13.8 mS/cm

14.1 Alarm Position

13.1 Alarm Width

Pre Tx Conductivity 13.8 mS/cm

SVS Profile None

Home Trends Dialysate Test & Options Heparin Kt/V AF Crit-Line Blood Pressure

Figure 40 – Entering Concentrate Information

Setting the Acid/Bicarbonate Alert

The Acid/Bicarbonate Alert option sounds an alarm when the fluid level in either of the concentrate jugs has been drained to 20 percent of its original amount. In addition to the alarm, a Low Alarm message such as “Low Acid Warning” or “Low Bicarb Warn” will appear in the Status Box. This alert aids the operator in maintaining adequate amounts of concentrate in the containers during treatment. Be sure to set the new volume in this screen whenever the concentrate containers are refilled.

1) From the “Dialysate” screen, select **Acid/Bicarb Alert**. The “Acid/Bicarb Alert” subscreen appears.

2) Select **Acid**. Using the keyboard, enter the actual amount, in liters, of concentrate in the acid jug.

3) Select **Bicarbonate**. Using the keyboard, enter the actual amount, in liters, of concentrate in the bicarbonate jug.

4) Select **Alert** until an **X** appears in the On checkbox.

5) Press **CONFIRM** to save the change.

6) Select **Dialysate** to exit the “Acid/Bicarb Alert” subscreen. The volume of each concentrate will count down as it is used.

Note: If the facility is on a centralized acid or bicarbonate supply system, enter zero to deactivate the alarm for that concentrate.

The top screenshot shows the following data:

- Conc:** 1.0K | 2.25Ca | NAT | 08-1231-3
- Dialysate Composition:**
 - TCD: 13.8 mS/cm
 - K+: 1.0 mEq/l
 - Ca⁺⁺: 2.25 mEq/l
 - Mg⁺⁺: 1.0 mEq/l
 - Ac: 4.0 mEq/l
 - Dex: 100 mg/dl
 - Base Na⁺: 137 mEq/l
 - Bicarbonate: 33 mEq/l
- Conductivity Limits:** 13.8 mS/cm (current), 14.1 mS/cm (Alarm Position), 13.1 mS/cm (Alarm Width)
- Alert Settings:** Pre Tx Conductivity: 13.8 mS/cm, SVS Profile: None

The bottom screenshot shows the following data:

- Volume in Container:**
 - Acid: 5.0 L
 - Bicarbonate: 6.0 L
- Alert Settings:** Alert: On (checked)

Figure 41 – Setting Acid & Bicarbonate Alerts

Conductivity

The Theoretical Conductivity (TCD) represents the expected conductivity for the selected concentrate at the set Na⁺ and bicarbonate levels. It is displayed above the electrolyte constituents on the left side of the “Dialysate” screen (see Figure 38 on page 83). The actual conductivity of the Final Dialysate is displayed above the conductivity bar graph on the right side of the “Dialysate screen.” It is represented by a horizontal bar in the conductivity graph. The bar appears green when the conductivity is within alarm limits, and turns red when the actual conductivity is outside the alarm window. With both concentrate supplies connected to the machine, a stable, accurate conductivity reading should be attained about five minutes after the concentrate is confirmed in the “Dialysate” screen.

If the ‘Independent Conductivity’ Service Mode option is set, the machine’s independent conductivity reading is also displayed on the “Dialysate” screen under the heading “Pre Tx Conductivity” (see Figure 38 on page 83).

Conductivity Limits

As the operator changes the sodium or bicarbonate settings, the TCD (Theoretical Conductivity) will change. The alarm limits are set around the TCD. The alarm window is the area between the upper and lower alarm limits. The upper and lower alarm limits are shown by yellow horizontal lines in the conductivity bar graph. They are set 0.5 mS/cm above and below the TCD by default. The conductivity alarm sounds when the actual conductivity of the dialysate climbs or falls outside of this window. The alarm window can be shifted up or down to within 0.5 mS/cm of the default setting using the **Alarm Position** button (and the keyboard), and widened or narrowed using the **Alarm Width** button (and the keyboard). The width of the alarm window can be set from a minimum of 0.6 mS/cm to a maximum of 1.0 mS/cm, within the range of 12.5–16.0 mS/cm.

The following examples illustrate how to set the conductivity alarm window:

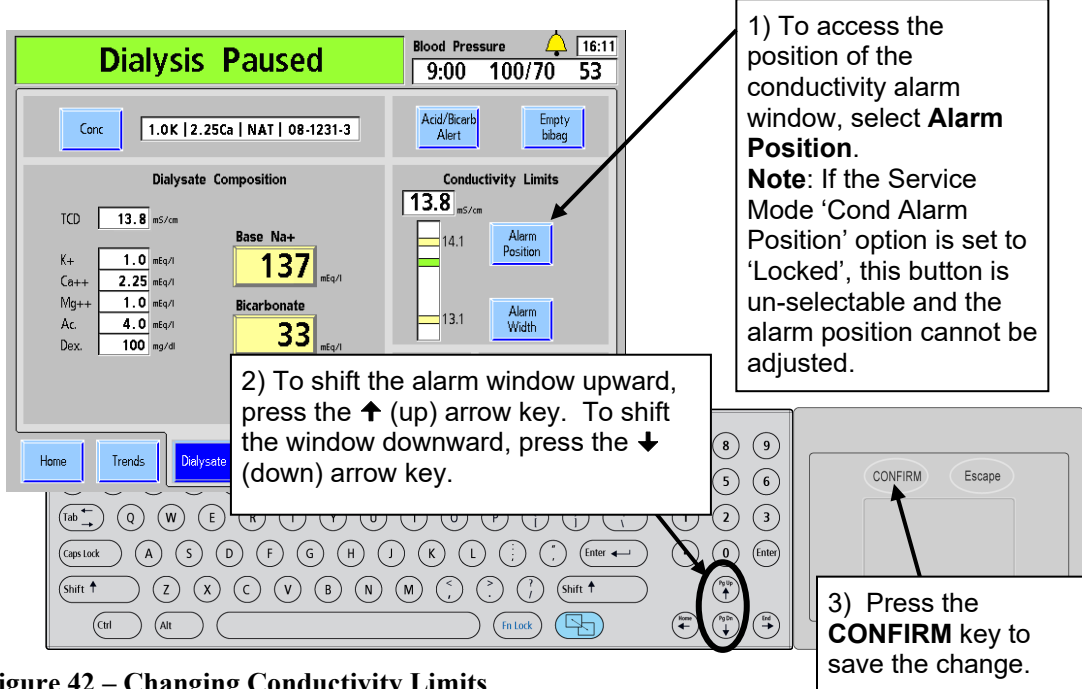

Figure 42 – Changing Conductivity Limits

Dialysis Paused

Blood Pressure 16:11
9:00 100/70 53

Conc 1.0K | 2.25Ca | NAT | 08-1231-3

Acid/Bicarb Alert Empty bibag

Dialysate Composition

TCD 13.8 mS/cm

K+ 1.0 mEq/l

Ca++ 2.25 mEq/l

Mg++ 1.0 mEq/l

Ac. 4.0 mEq/l

Dex. 100 mg/dl

Base Na+ 137 mEq/l

Bicarbonate 33 mEq/l

Dialysate Flow On Off

Conductivity Limits

13.8 mS/cm

14.1

Alarm Position

13.1

Alarm Width

Pre Tx Conductivity 13.8 mS/cm

SVS Profile None

Home

2) Press the ↑ (up) arrow key to increase the distance between the upper and lower alarm limits. Press the ↓ (down) arrow key to decrease it.

Kt/V AF Crit-Line Blood Pressure

CONFIRM Escape

3) Press **CONFIRM** to save the new alarm settings.

Figure 43 – Changing Conductivity Limit Width



Warning! Always verify the conductivity and approximate pH of the dialysate solution through independent means before initiating each dialysis treatment. Independent means could be by using an external conductivity meter, pH meter, pH paper or by using the machine’s independent conductivity test. An approximate pH check is also part of the machine’s independent conductivity test when a bibag disposable is connected. Verify that the conductivity is within 0.4 mS/cm of the theoretical conductivity value (TCD) and the pH is between 6.9 and 7.6 if using a pH meter or pH paper. If conductivity and pH are not within these limits, do not initiate dialysis. The machine’s independent conductivity test relies on the use of prequalified manufactured acid concentrates or verified batch concentrates; the pH check relies on the use of these concentrates and the bibag. For more information on collecting a dialysate sample for external testing, see “Testing the Dialysate” on page 359.

Home Screen Settings

After entering the data in the “Dialysate” screen, treatment parameters regarding treatment length, ultrafiltration, and the administration of sodium can be entered in the “Home” screen. The “Home” screen can also provide a view of the status of the treatment once it has begun (see “Home Screen Monitoring” on page 138). Unless otherwise described, enter or change a dialysate-related value by following the procedure described in “Entering a Parameter” on page 80.



Note: The 2008T hemodialysis machine is equipped with both visual cues and audible alarms to alert the operator to potential problems. In every alarm condition, assess the patient for any changes in his/her physiologic state. Ensure that the patient’s access is exposed and all connections in the extracorporeal circuit are secure and visible during the entire procedure. It is the responsibility of the dialysis personnel to provide safe and effective dialysis treatment. Document all unusual events.

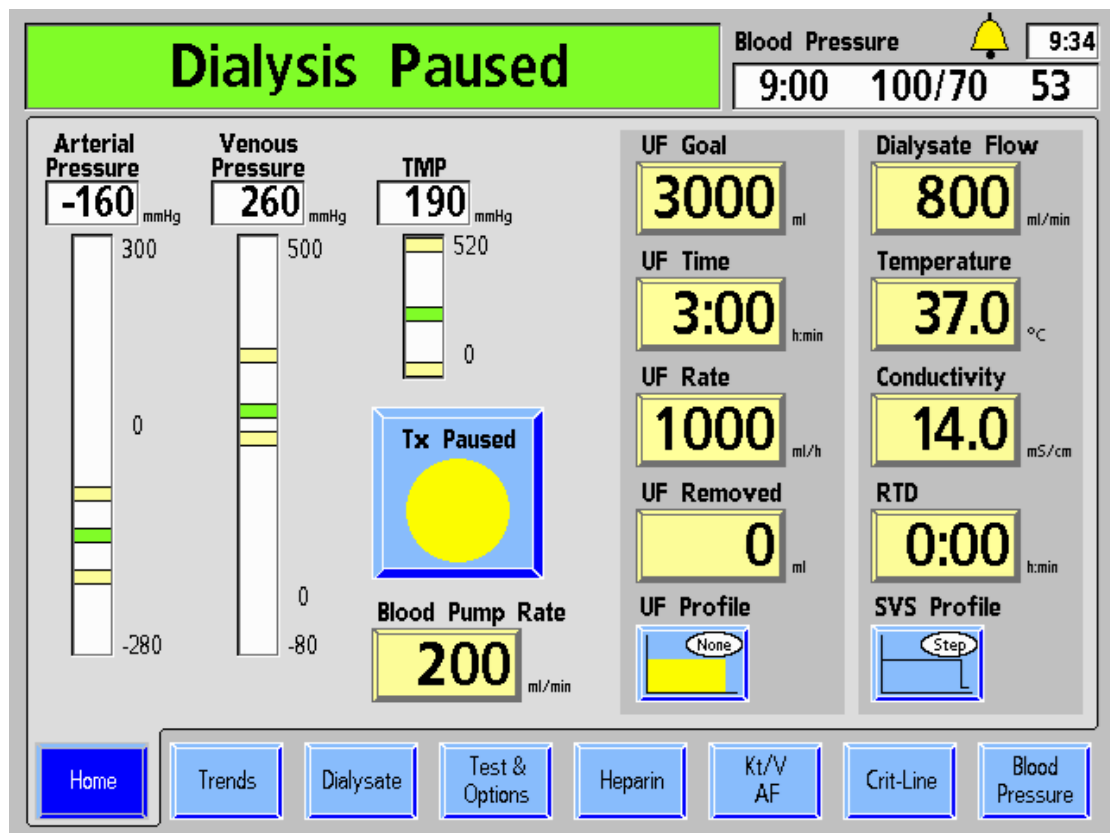

Figure 44 – The Home Screen (showing functional software version 2.72 or later)



What to do from this screen...





Enter the prescribed treatment settings for:

- UF Goal
- UF Time
- Check UF Rate (Calculated from UF Goal and UF time)
- Dialysate Flow
- Dialysate Temperature
- Treatment Time (RTD) (optional; RTD will transfer from UF time if UF removed is 0 when UF is turned on.)
- Start or pause the Tx Clock
- Set the speed of the blood pump
- If prescribed, access the proper screen to set treatment parameters for:
 - UF profile
 - Sodium Variation (SVS) profile

The following table provides a description of the data buttons available in the “Home” screen.

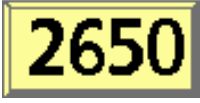
Table 15 – The Home Screen Features

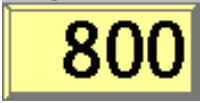
Feature	Function
<p>UF Goal</p> 	<p>The amount of fluid (in ml) to be removed during the entire treatment is entered here. This button is also available in the “UF Profile” subscreen if a profile is to be used to vary the rate of ultrafiltration during treatment. If the UF Goal is set to zero, the UF Time will also change to zero; the UF Rate may then be set independent of UF Time and UF Goal.</p> <p> Note: Setting the UF Goal to zero while the blood pump is still running will cause the UF Rate to be set to a minimum of 10 ml/hr. If the blood pump is stopped, setting the UF Goal to zero causes the UF Rate to be set to a minimum of 70 ml/hr (or 300 ml/hr if the High Flux option is set on the Test & Options screen). To stop ultrafiltration entirely (with a UF Rate of zero), simply press the UF on/off key on the control panel keypad to set it to 'off'.</p>
<p>UF Time</p> 	<p>The length of treatment time during which ultrafiltration will occur is entered here in hours and minutes (hr: min). UF Time will generally be equal to treatment time and will automatically transfer to the RTD button. Once treatment begins, this button acts as a countdown timer indicating the amount of time left for ultrafiltration. This time can be increased or decreased by the operator at any time. Changing the UF Time or UF Goal will change the UF Rate accordingly except when the UF Goal is set to zero. If the UF Rate is adjusted, the UF Time will be automatically calculated without affecting the UF Goal. To run Isolated Ultrafiltration, see “Running Isolated UF as Sequential Dialysis” on page 101. Blood alarms or online pressure holding tests temporarily stop this timer.</p>

Feature	Function
UF Rate 	Enter here, in 10 ml/hr increments, the rate fluid will be drawn from the patient (ultrafiltration). Generally the UF rate is not entered, but rather automatically calculated from the UF Goal and UF Time. If the UF Rate value is manually changed, the UF Time value will automatically change accordingly.
UF Removed 	<p>Displays the total amount of ultrafiltration removed in ml. The counter keeps track of the UF in 1 ml increments.</p> <p> Warning! UF Removed must be reset to 0 before initiating treatment. If the UF Removed is not reset, the amount displayed will be used in the UF calculation, resulting in incorrect UF removal from the patient.</p>
Dialysate Flow 	<p>The prescribed dialysate flow rate, in ml/min, is entered here. The rate, displayed in ml/min, can be entered from 0 to 800 in increments of 100 (plus the setting of 150 ml/min). If flow is set for sequential dialysis (Isolated UF), the button displays 'SEQ'. For more information on sequential dialysis, see page 101.</p> <p>To turn off dialysate flow, select the Dialysate Flow button and either use the ↓ key to scroll down to OFF or press the 0 key and then press the CONFIRM key. To turn dialysate flow back on, select the Dialysate Flow button, set it to the desired value, and press the CONFIRM key.</p> <p>1.5x or 2x auto flow may be selected by scrolling up past 800. If this automatic selection is set, the dialysate flow rate will be set to approximately 1.5 or 2 times the blood flow rate between 500 and 800 ml/min, in 100 ml/min increments. When 1.5x or 2x is selected and confirmed, the dialysate flow rate will be indicated with the letter “a” preceding the dialysate flow rate, such as: “a500”.</p> <p> Warning! Setting the dialysate flow to a rate that is too low can adversely affect dialyzer clearance and reduce treatment efficacy. If 1.5x or 2x selects a flow rate below that prescribed, the dialysate flow may be manually set to the desired value.</p> <p> Note: The value displayed in the Dialysate Flow button will flash when dialysate flow is set to 'OFF' from the “Dialysate” screen (see page 83 for more information). Select the Dialysate Flow toggle-button and press the CONFIRM key to turn the dialysate flow back on when desired.</p> <p>Note: Dialysate flow changes are generally delayed about 30 seconds after a change in the blood pump rate to prevent unnecessary flow adjustments during priming and to allow the machine to stabilize before determining the new dialysate flow rate.</p> <p>Note: With Auto Flow, even though the dialysate flow is expressed as a multiple of the blood flow rate, the dialysate flow is not exactly the calculated multiple of the blood flow. The dialysate flow changes in increments of 100 ml/min only. In order to be conservative with lower dialysate flow rates, each transition point to the next higher dialysate flow rate is somewhat earlier than one would calculate. See the table on page 364 for more details.</p>





Feature	Function
Temperature 	<p>The desired temperature of the dialysate in degrees Celsius is set here. Once this setting is confirmed, the button will display the actual temperature. The allowable temperature setting range from 35 °C to 39 °C. A temperature alarm occurs when the actual temperature rises or falls 2 °C beyond the set temperature. If the dialysate flow is set to OFF or SEQ, the temperature is “N/A”, since there is no dialysate flow.</p>
Conductivity 	<p>The actual conductivity is displayed here. Selecting this button displays the “Dialysate” screen where the Theoretical Conductivity (TCD) is displayed for the selected concentrates settings. See page 82 for more information.</p>
RTD 	<p>RTD (Remaining Time of Dialysis)—At the start of the treatment, the time entered in the UF Time button is automatically transferred to the RTD button if UF removed is 0. If it is necessary to change the treatment time, RTD can be entered here. A dialysate or blood alarm will stop this timer.</p>
UF Profile 	<p>Ultrafiltration (UF) Profile—Opens the “UF Profile” subscreen from which a profile for executing variable rate ultrafiltration can be selected. The button displays the current profile selection. For more information, see “Setting a UF Profile” on page 98.</p>
SVS Profile 	<p>Sodium Variation System (SVS) Profile—This button opens the “SVS Profile” subscreen from which the operator can select how sodium is varied during the course of the treatment. For more information, see “Sodium Variation System” on page 103. This button is colored green when an SVS profile is running (functional software version 2.34 or later).</p> <p>If the SVS option is set to ‘No’ in Service Mode, this button will not be displayed.</p>
 	<p>The Treatment Clock button is selected and confirmed to start or pause the treatment. The green segment of the pie chart represents the amount of treatment completed. The green segment grows as the treatment progresses. The circle will be completely green when RTD is equal to zero. During treatment, this button displays the message, “Tx Running.”</p> <p>Selecting and confirming this button will pause the treatment clock and the button will display the message, “Tx Paused.” When the treatment is paused, the RTD, heparin infusion time, and UF time each stop counting down, the UF and heparin pumps stop, and the SVS time is paused. The UF key LED indicators will flash. Turning the Treatment Clock back on will restore operation of these parameters unless turned off with the respective front panel on/off key or on-screen button.</p> <p>The first time the Treatment Clock is turned on, the UF Removed is reset to 0 and the UF, Heparin pumps and SVS & UF programs are turned on and a blood pressure reading is taken, if applicable.</p>
Blood Pump Rate 	<p>Blood Pump Rate—Displays the speed of the blood pump and allows the operator to set it from the display screen in addition to the module. The rate, displayed in ml/min, can be entered from 0 to 600 in Dialysis or 0 to 300 in SLED in increments of 5. Setting the blood flow rate to zero will stop the blood pump. The blood flow rate flashes when the blood pump is stopped.</p>

Table 16 – UF Control Key

Key	Function
 <p>The image shows a rectangular button with a grey background. At the top center, there is a small green circle representing a light. Below the circle, the text 'UF on/off' is printed in a dark grey font. A yellow oval highlights the entire button area.</p>	<p>The UF on/off key turns the ultrafiltration pump on or off. During ultrafiltration, the green light is illuminated.</p> <p>This light flashes when ultrafiltration is interrupted, and the UF Time countdown stops. Operation will resume when the Treatment Clock is turned on or the UF on/off key is pressed.</p> <p>If the UF on/off key is pressed during dialysis to turn off the UF pump, it will not resume with the Treatment Clock button.</p>

Ultrafiltration

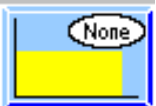
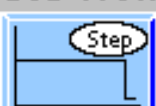
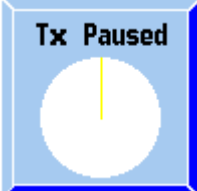
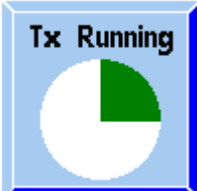
Use the **UF Goal** and **UF Time** buttons to determine the necessary UF rate for the treatment. The maximum UF rate (set in Service Mode) is limited to between 1000 ml/hr or 4000 ml/hr (at 1000 ml/hr intervals), depending on the option selected. The UF Goal is limited to 9990 ml. Reset the UF removed to zero after setting the UF time. The ultrafiltration will be at a steady rate throughout the treatment. When the **UF on/off** key is turned off, no ultrafiltration is occurring. When the **Tx Clock** button is turned on, the UF pump (as well as a number of other functions) is automatically started. When the UF goal has been achieved, the UF time is set to 0:00, and the UF rate goes to 70 ml/hr (conventional dialyzers) or 300 ml/hr (high flux dialyzers). If a profile (variation during treatment) is desired for the UF rate, use the **UF Profile** button.



Warning! When using high-flux dialyzers with low UF rates there is a possibility of back-filtration. Back filtration depends on: type of high-flux dialyzer, flow resistance on dialysate and blood sides, and blood viscosity.



Warning! Weigh the dialysis patient before and after treatment to check against fluid removal discrepancies.





Setting a UF Profile

The different UF Profiles available are used to improve patient comfort during dialysis by providing alternating patterns of high and low rates of ultrafiltration. This also allows the fluid in the patient to equilibrate more completely between the intracellular and extracellular compartments. A UF profile divides the UF Time into twelve equal segments of differing UF rates, based on the profile, in order to reach the prescribed UF Goal.

To view the available profiles, select the **UF Profile** button on the “Home” screen. The “UF Profile” subscreen (see Figure 46) will open displaying up to eight possible profiles and a selection for “None.” The first four profiles are standard profiles. The fifth through eighth profiles are programmable to meet the needs of the clinic.

Table 17 – The UF Profile Subscreen Buttons

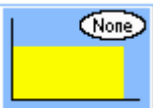
Button	Function
	<p>Profile 1 – Increases the UF rate for approximately the first 40% of the treatment then gradually decreases</p>

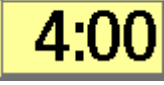
Button	Function
	<p>Profile 2 – Aggressive level UF with a gradual decline.</p>
	<p>Profile 3 – Moderate level UF increase throughout approximately the first 60% of treatment and declines to a minimum.</p>
	<p>Profile 4 – Low-level UF moving into a series of decreasing peaks and valleys for the first two-thirds of the treatment followed by a plateau of moderate UF to completion.</p>
	<p>Profiles 5, 6, 7, 8 – Customizable in Service Mode, see page 338 for more information. The images on these buttons will match the appearance of the customized profiles.</p>
	<p>None – Ultrafiltration occurs at a constant minimum rate calculated from the set UF Time in order to reach the set UF Goal. It does not mean that no ultrafiltration will occur.</p>
<p>UF Goal</p> 	<p>UF Goal – This is the value from the “Home” screen, see page 94 for more information.</p>
<p>Maximum UF Rate</p> 	<p>Maximum UF Rate – Once the UF Goal and UF Time are entered, the Maximum UF Rate for the selected profile is calculated and displayed here. The calculated rate cannot exceed the Maximum UF Rate limit set in Service Mode, see “Max UF Rate” on page 329.</p>
<p>UF Time</p> 	<p>UF Time – This is the value from the “Home” screen, see page 94 for more information. When a UF profile is selected and confirmed, the machine will apply the new UF profile to the remaining UF time in twelve equal segments.</p>



Note: Any of the four customizable profiles (5 through 8) that are not programmed will function the same as the None profile. See “UF Profile Screen: Creating Custom UF Profiles” on page 338 for instructions on how to customize these profiles.

To initiate an ultrafiltration profile, select one of the profiles by selecting the appropriate button. Enter the desired UF Goal and UF Time values using the numeric keys or the **↑** or **↓** (up or down) keys on the keyboard and confirming with the **Enter** or **CONFIRM** keys. The UF Goal and UF Time values from the “Home” screen will appear in the “UF Profiles” subscreen. Once the UF Goal and UF Time are entered, the Maximum UF Rate for the selected profile is calculated and displayed in the corresponding text box on the screen.

To enter an ultrafiltration profile:

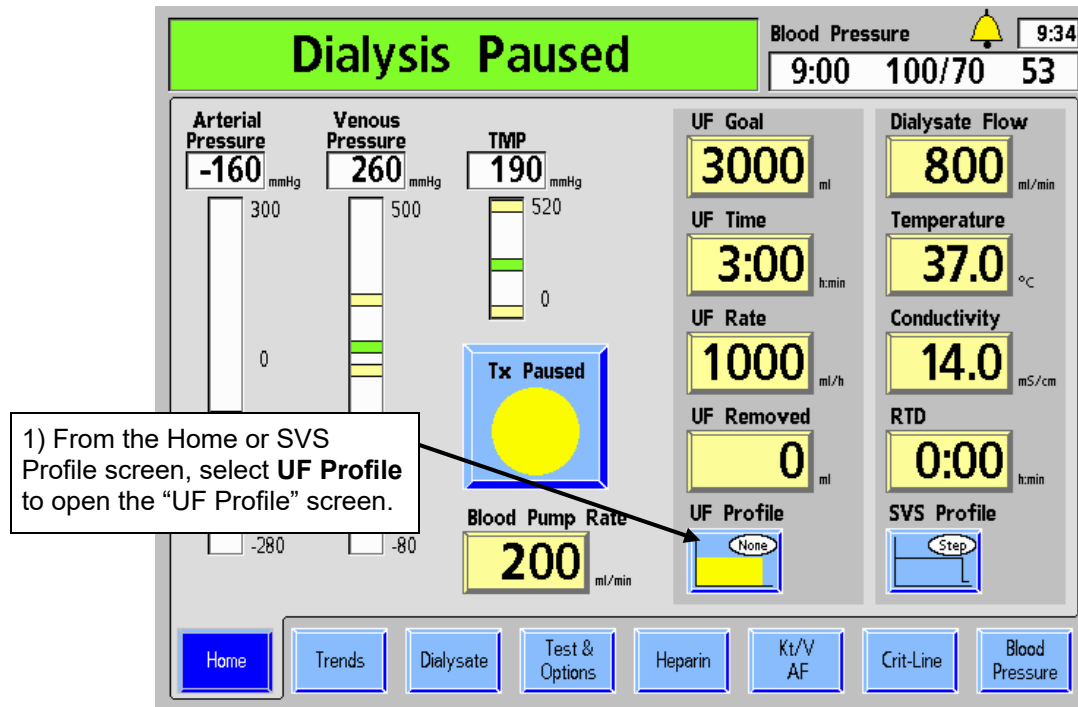

Figure 45 – Setting a UF Profile

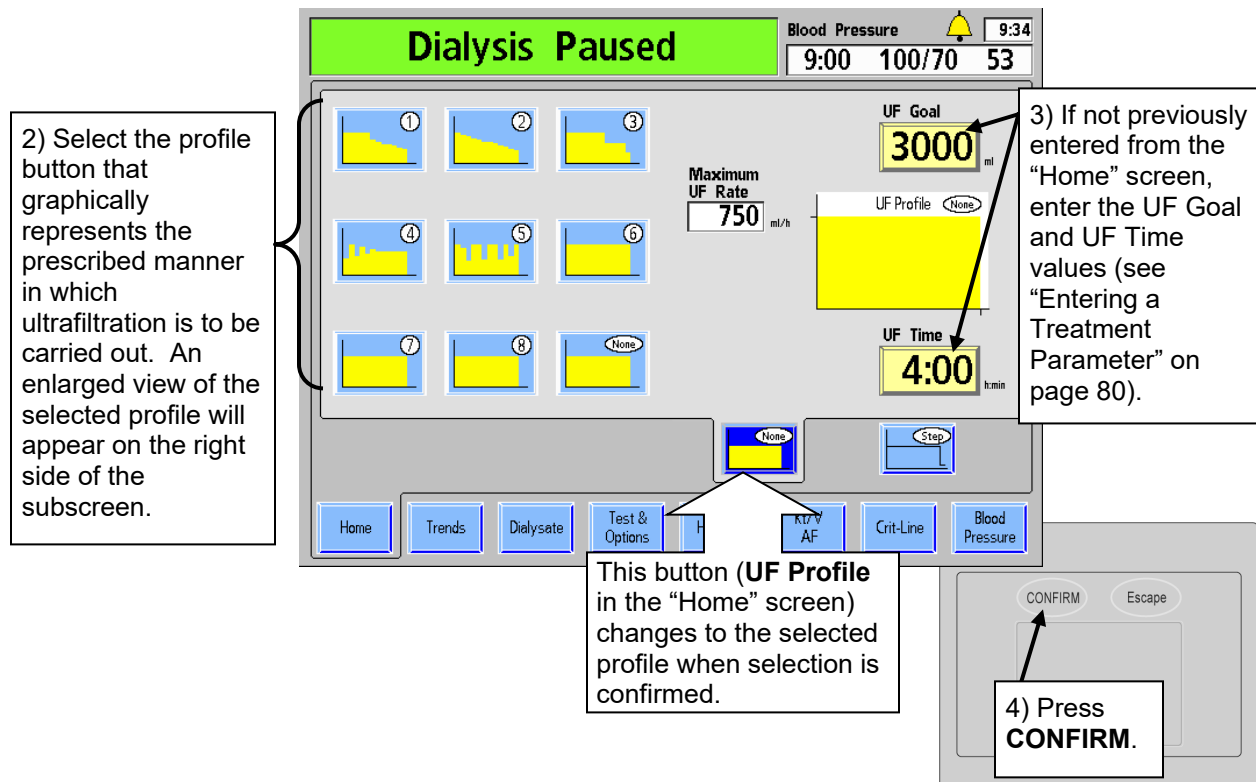

Figure 46 – Setting UF Profile Parameters



Note: The “None” profile performs ultrafiltration at a constant rate. It does not mean that no ultrafiltration will occur.

The maximum UF rate is displayed for the selected profile, UF Goal, and UF Time. If the maximum UF Rate is too high (beyond the configuration of the machine), a message appears in the Dialogue Box located in the upper, right corner of the screen. The operator has the option of increasing the UF Time, reducing the UF Goal, or selecting another profile.

- To change the profile, select the corresponding profile button.
- To change the time, select the **UF Time** button.
- To change the UF goal, select the **UF Goal** button. The maximum ultrafiltration rate, based on the UF Goal, Time & Profile, will be calculated and displayed in the Maximum UF-Rate display.

When all ultrafiltration parameters are satisfactory, press **CONFIRM** to save the changes, then exit from the “UF Profile” screen. The machine will apply the new UF profile to the remaining UF time in twelve equal segments.

Isolated Ultrafiltration

Isolated Ultrafiltration (UF) is sometimes prescribed for patients suffering from excessive fluid retention. During Isolated UF the machine does not run dialysate through the dialyzer, it performs only ultrafiltration, pulling the patient’s excessive fluid from the bloodstream via the dialyzer with no diffusion.

Running Isolated UF as Sequential Dialysis

Isolated UF is performed using the “SEQ” (Sequential) setting on the “Home” screen’s Dialysate Flow button. Sequential dialysis refers to a two-stage treatment in which one of the stages consists solely of Isolated UF followed by hemodialysis. Using Sequential dialysis, Isolated UF is usually performed at the beginning of a standard dialysis treatment, although it can also be administered during treatment. The operator can start or stop the Isolated UF option at any time. After 60 minutes of Isolated UF, the machine will notify the operator that dialysate flow has been off for 60 minutes. At that time, the operator must choose to turn on dialysate flow and begin hemodialysis or to continue with Isolated UF



Note: Setting and confirming the Dialysate Flow to ‘0’ will turn it OFF instead of running sequential dialysis. After five minutes of Isolated UF, an alarm sounds and the Low Alarm message, “5 Minutes Flow Off,” appears in the Status Box. The operator has the option of continuing Isolated UF or starting dialysis. This alarm occurs only once.

To set the 2008T hemodialysis machine for sequential dialysis:

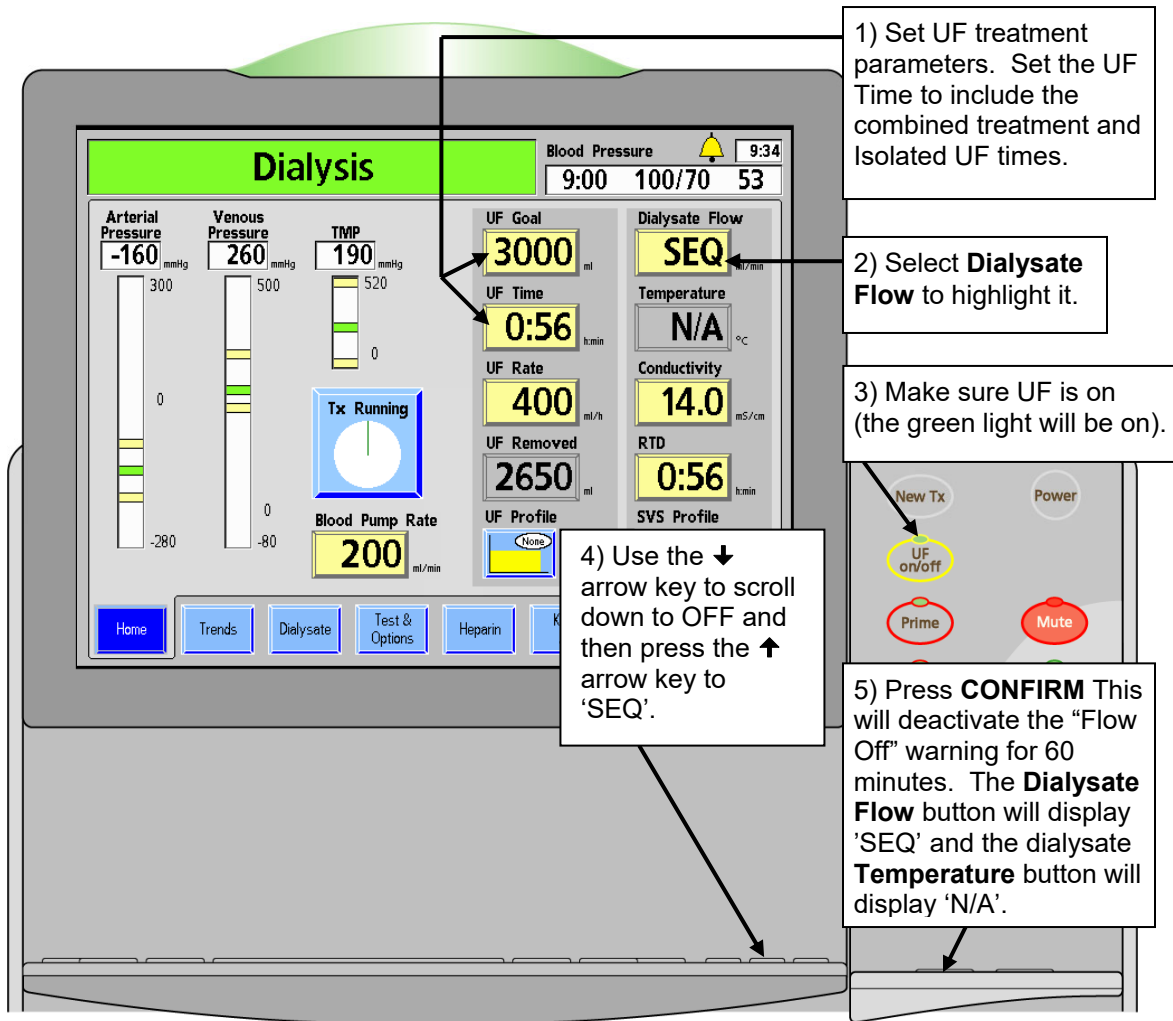

Figure 47 – Setting Sequential Dialysis

After sixty minutes of Isolated UF, a Low Alarm sounds and the message, “60 Minutes Flow Off,” appears in the Status Box. The operator has the option of continuing Isolated UF or starting hemodialysis. This alarm occurs only once.

- **To continue Isolated UF:** press the **Reset** key on the control panel keypad. This will silence the alarm and clear the message. Isolated UF will continue for the rest of the prescribed treatment time or until dialysate flow is turned back on.
- **To start hemodialysis:** select the **Dialysate Flow** button in the “Home” screen, set it to the prescribed rate using the keyboard, and press **CONFIRM**. The machine will go into bypass mode until dialysate temperature and conductivity settings are attained (about two minutes). Hemodialysis will run for the rest of the prescribed treatment time.



Note: Dialysate flow must be re-established for a minimum of five minutes before resuming Isolated UF or the Low Alarm will reoccur.

Sodium Variation System



Note: If the SVS option is set to ‘No’ in Service Mode, the Sodium Variation System is not available (functional software version 2.34 or later).

Physicians may prescribe additional sodium in the dialysate to assist in the prevention of hypotension, cramping, and disequilibrium syndrome. The Sodium Variation System (SVS) option provides the operator with an automated method of changing the concentration of dialysate sodium in accordance with the physician’s prescription.

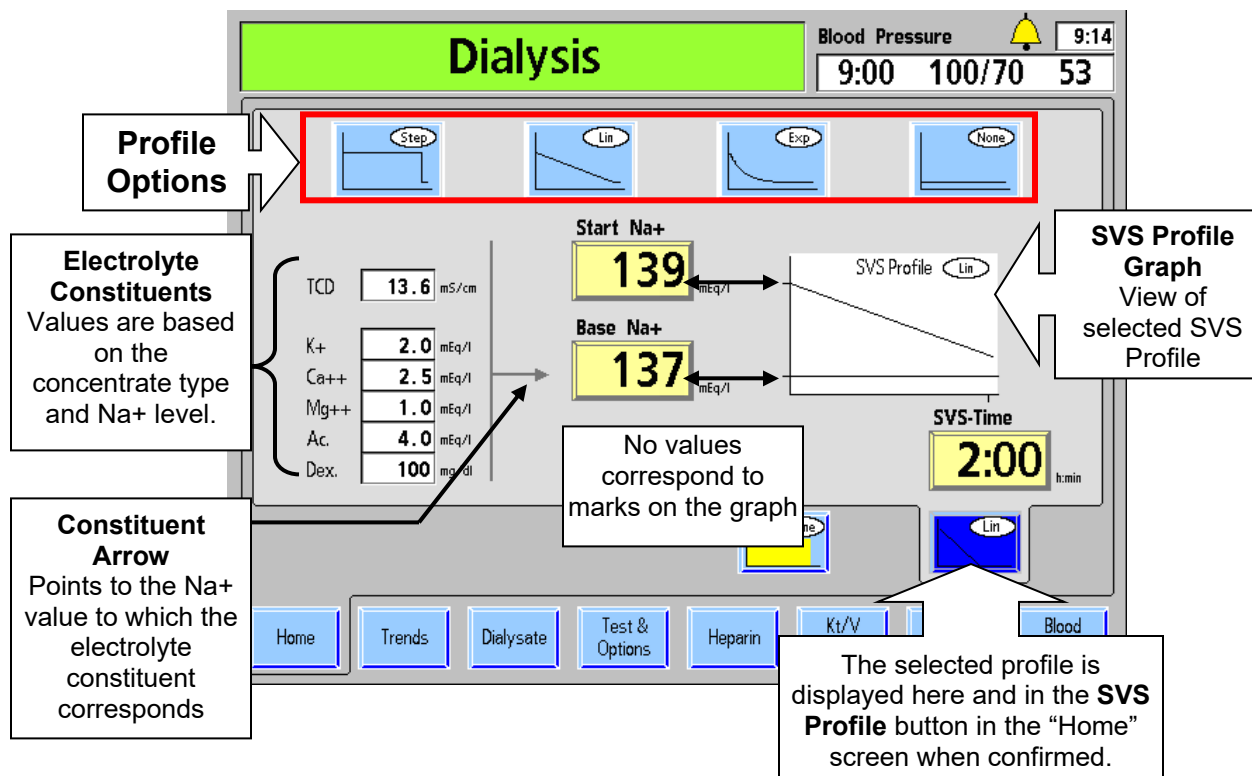

Figure 48 – The SVS Profile Screen



The Sodium Variation System (SVS) allows the standard dialysis treatment to be modified so that the acid/acetate concentrate, which contains most of the sodium in the dialysate, is varied according to a specific profile. There are three basic profiles available: Step, Linear, and Exponential, or the operator may select None. In each profile, a higher level of sodium (Start Na⁺) is set initially. By the end of SVS operation, the sodium level is back to the Base level. Selecting None maintains the sodium at the Base level through the course of the treatment. The default profile is None.

The following table describes the buttons on the “SVS” subscreen that facilitates the implementation of the SVS.

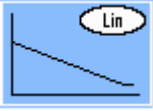

Note: The constituents concentration is recalculated each time the ↑ or ↓ (up or down) arrow key is pressed. If the Na⁺ or Bicarbonate level is entered with a numeric key, they are only recalculated after the **CONFIRM** key is pressed or a parameter button is selected for a different parameter.

Table 18 – The SVS Subscreen Buttons

Button	Function
	<p>Step Profile – Once stable base conductivity has been achieved, selecting this program will initiate the increase in dialysate sodium. The dialysate sodium will rise to the program peak sodium level (Na^+). The dialysate sodium will remain at this level for the duration of the program time. When the program time has elapsed, the dialysate sodium will drop back down to the baseline sodium level.</p>
	<p>Linear (Lin) Profile – Once stable base conductivity has been achieved, selecting this program will initiate the increase in dialysate sodium. The dialysate sodium will rise to the program starting peak sodium level (Na^+). From this point, the dialysate sodium will decrease toward the baseline sodium level in a straight diagonal line. This drop will occur over the duration of the program time. When the program time has elapsed, the dialysate sodium will be at the baseline sodium level.</p>
	<p>Exponential (Exp) Profile – Once the stable base conductivity has been achieved, selecting this program will initiate the increase in dialysate sodium. The dialysate sodium will rise to the program's starting peak sodium level (Na^+). From this point, the dialysate sodium will decrease over the program time, toward the base sodium level in a smooth curved line. When the program time has elapsed, the dialysate sodium will be back at the baseline sodium level.</p>
	<p>None—The level of sodium set in the Base Na^+ button is maintained throughout the treatment, with <u>no</u> variations. It does not mean that no sodium will be used.</p>
<p>Start Na^+</p> <p>139</p>	<p>The prescribed peak sodium level that will be set at the beginning of the SVS Profile is accessed here. This value has an allowable range from Base Na^+ to 155 mEq/L. The value displayed corresponds to the upper tick mark on the vertical axis of the profile graph. This button will appear grayed out if the None profile is selected.</p>
<p>Base Na^+</p> <p>137</p>	<p>The prescribed base sodium level of the dialysate can be viewed here or in the “Dialysate” screen. The Base Na^+ has an allowable range of 130 to 155 mEq/L. This value corresponds to the lower tick mark on the vertical axis of the profile graph.</p>
<p>SVS-Time</p> <p>2:00</p>	<p>This button is used to access the program time length in hours and minutes (0:00 to 9:59) prescribed for SVS operation. Once the SVS is started, it functions as a count down timer displaying the time remaining in the SVS program. The end time is represented in the profile graph by a tick mark on the horizontal axis.</p>

To set an SVS profile:

1) From the “Home” screen, select the **SVS Profile** button. The SVS Profile window opens.

2) Select the prescribed profile by selecting the corresponding button from among the four options located in a row along the top of the screen.

3) Select **Start Na+**, and enter the starting maximum Na⁺ value using the keyboard.

4) Select **Base Na+**, and, using the keyboard, enter the final Na⁺ concentration value to be reached at the end of the SVS profile.

5) Select the **SVS-Time** button and, using the keyboard, enter the running time for the SVS profile.

6) Press **CONFIRM** to save the SVS settings. The **SVS Profile** button on the “Home” screen will be colored green when the selected SVS profile is running (functional software version 2.34 or

Figure 49 – Entering an SVS Program

The SVS timer is activated when the **Tx Clock** button is initially selected and confirmed to start treatment. The SVS profile parameters can only be changed if the SVS is turned off using the ‘None’ profile button.



Note: During the SVS program, the actual conductivity bar, shown in bar graph on the Dialysate screen, should be centered in the alarm window. This may require shifting the position of the upper and lower alarm limits using the **Alarm Position** button. See “Conductivity Limits” on page 91.

Note: If any SVS parameter is changed after the program has started (SVS must be turned off to change), a new SVS program is initiated with the displayed SVS-Time and Start Na⁺.

The Electrolyte Constituents

The acid concentrate is the major source of electrolytes in the dialysate. Increasing the Na⁺ concentration in the dialysate, therefore, increases the amount of acid concentrate.

Increasing the amount of acid concentrate also increases the concentration of the other electrolytic constituents. These changes can be observed in the electrolyte constituents shown in the left side of the “SVS Profile” subscreen.

To observe the electrolyte constituents for the higher concentration of sodium, select **Start Na⁺**. The values in the left column change to reflect the increased sodium (see Figure 48 on page 103). Select **Base Na⁺** to observe the constituents at the base concentration. The arrow indicates which of the Na⁺ concentrations corresponds to the values. If neither button is highlighted, the electrolyte constituents values default to the Base Na⁺ setting, as indicated by the arrow.

Operation

Once the SVS program is started, the maximum sodium level (Start Na⁺) is reached after about three minutes. The theoretical conductivity (TCD) will immediately adjust to the expected conductivity for the selected Na⁺ level. As the actual conductivity rises, the alarm window will also track upward, to within the maximum conductivity alarm window limit of 0.5 mS/cm above TCD. While the alarm window is rising, the TCD may be outside of the alarm limits. The machine, however, may not be in an alarm state because the limits are tracking the actual conductivity. After the tracking is complete, the alarm window moves automatically to the expected conductivity based on the selected parameters and starting alarm limits. The SVS-Time starts counting down when the Start Na⁺ level is reached.

If an SVS program is in progress, selecting and confirming the **None** profile will pause the program. The conductivity will return to the Base Na⁺ level and the SVS-Time countdown stops. Alarms may occur as the conductivity stabilizes. The operator has two options:

- Restarting the program by re-selecting the desired SVS Profile and pressing the **CONFIRM** key. The **SVS-Time** and **Start Na⁺** values may need to be adjusted.
- Terminate the program by selecting the **SVS Time** button on the “SVS Profile” subscreen, entering zero using the keyboard, and pressing **Enter/CONFIRM** or by changing profile to “None” and pressing **CONFIRM**

Heparin Screen Settings

The “Heparin” screen settings control the 2008T heparin pump operation. It can be set to deliver heparin in a bolus dose and at a consistent rate during the treatment.

What to set in this screen...

- The Syringe (manufacturer and size)
- Delivery Rate
- Infusion Time
- Bolus Dose (if administered)

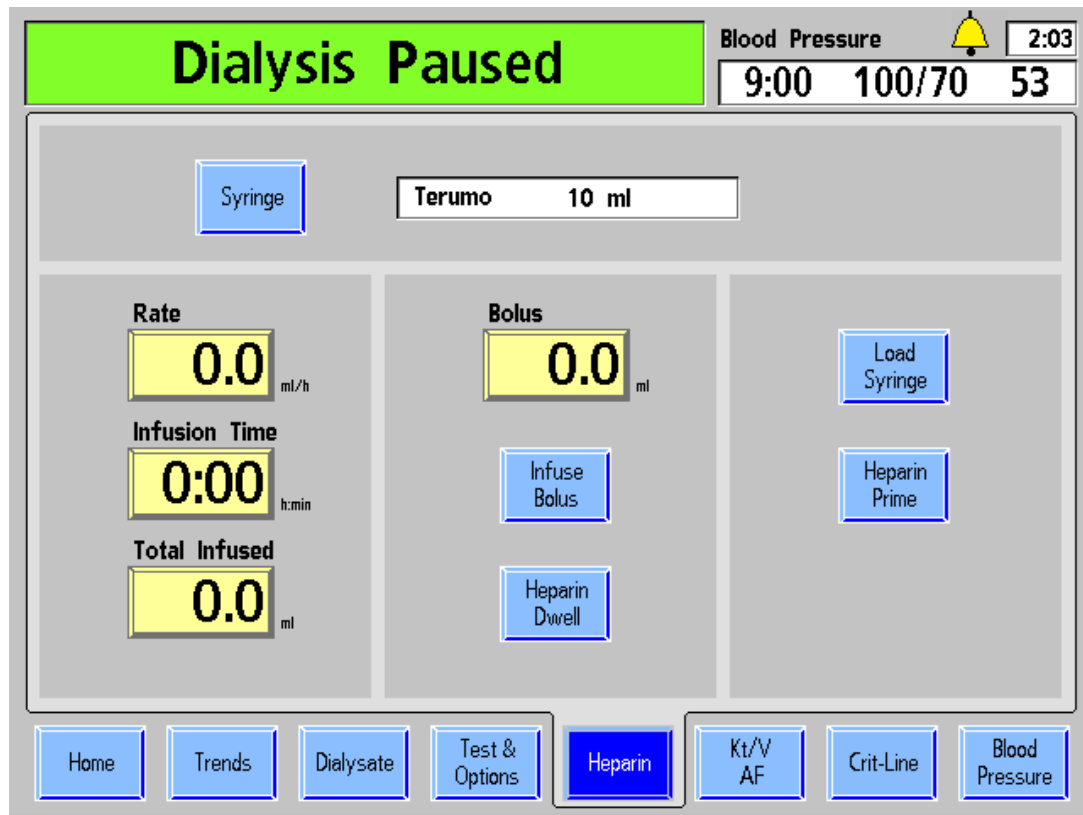

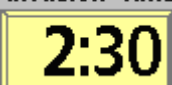

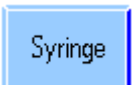
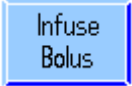

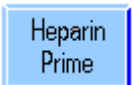
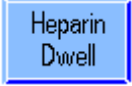

Figure 50 – The Heparin Screen

Table 19 – Heparin Screen Buttons

Button	Function
Rate 	The Rate button displays the rate at which heparin is dispensed during treatment. It can be set from 0.0 to 9.9 ml/hour. Setting the rate to 0.0 turns off the heparin pump.
Infusion Time 	The Infusion Time button displays the amount of time in hours and minutes that the heparin pump will deliver heparin. The program time can be set from 0 to 9:59. For the heparin pump to stop at a desired time automatically, the operator must set an Infusion Time. When the heparin pump is On, this time will count down to 0:00 and stop heparin delivery. Infusion Time can be set to zero only when the heparin pump is Off.
Total Infused 	The Total Infused button displays the current total amount of heparin delivered by the heparin pump (including the bolus). Total Infused can be reset to 0 with the keyboard and pressing the CONFIRM key when the Heparin pump is Off.
Bolus 	The amount of heparin to be delivered as a bolus infusion is entered here. The heparin pump delivers the bolus infusion at a rate of about 0.17 ml/sec (1 ml/6 seconds) for a 10 cc syringe. This amount can be set from 0.0 to 9.9 ml. During delivery, the Bolus amount is added to the amount shown in the Total Infused button.
	The Syringe button opens a menu listing various syringe types. The operator selects the syringe matching the one that will be used during treatment.
	The Infuse Bolus button activates the heparin delivery system to administer the amount of heparin displayed in the Bolus button. Once activated, the actual delivery is accomplished by pressing CONFIRM . Afterwards, the heparin pump will infuse heparin at the rate displayed in the Rate button.
	Selecting the Load Syringe button, followed by the CONFIRM key, fully retracts the heparin pump carriage to allow the mounting of the syringe in the pump. Pressing the Escape key will stop the travel of the carriage.
	The Heparin Prime button initiates a process to fill the Heparin line. Once a syringe is mounted in the pump, select the Heparin Prime button, and then press the CONFIRM key. The syringe plunger is pushed upward into the barrel while the CONFIRM key is pressed.
	The optional Heparin Dwell button (enabled in Service Mode) acts as a five minute timer after a manual heparin bolus is administered. To use the timer, select the Heparin Dwell button and press the CONFIRM key. This will cause the Status Light above the display screen to flash yellow at half-second intervals for five minutes while the heparin is dwelling. After the five minutes has elapsed, the Status Box will display the message, "Heparin Dwell Complete," and the Status Light will turn green and continue to flash until the operator presses the Reset key.



Warning! If no time is set in the **Infusion Time** button and the heparin pump is turned on, it will run at the selected rate until the syringe is empty or the heparin pump is turned off. The heparin pump should be monitored to verify the intended infusion during treatment.

The Heparin Delivery System



Warning! The correct syringe type must be selected to ensure an accurate infusion.

To prepare the heparin delivery system using the features on the “Heparin” screen:

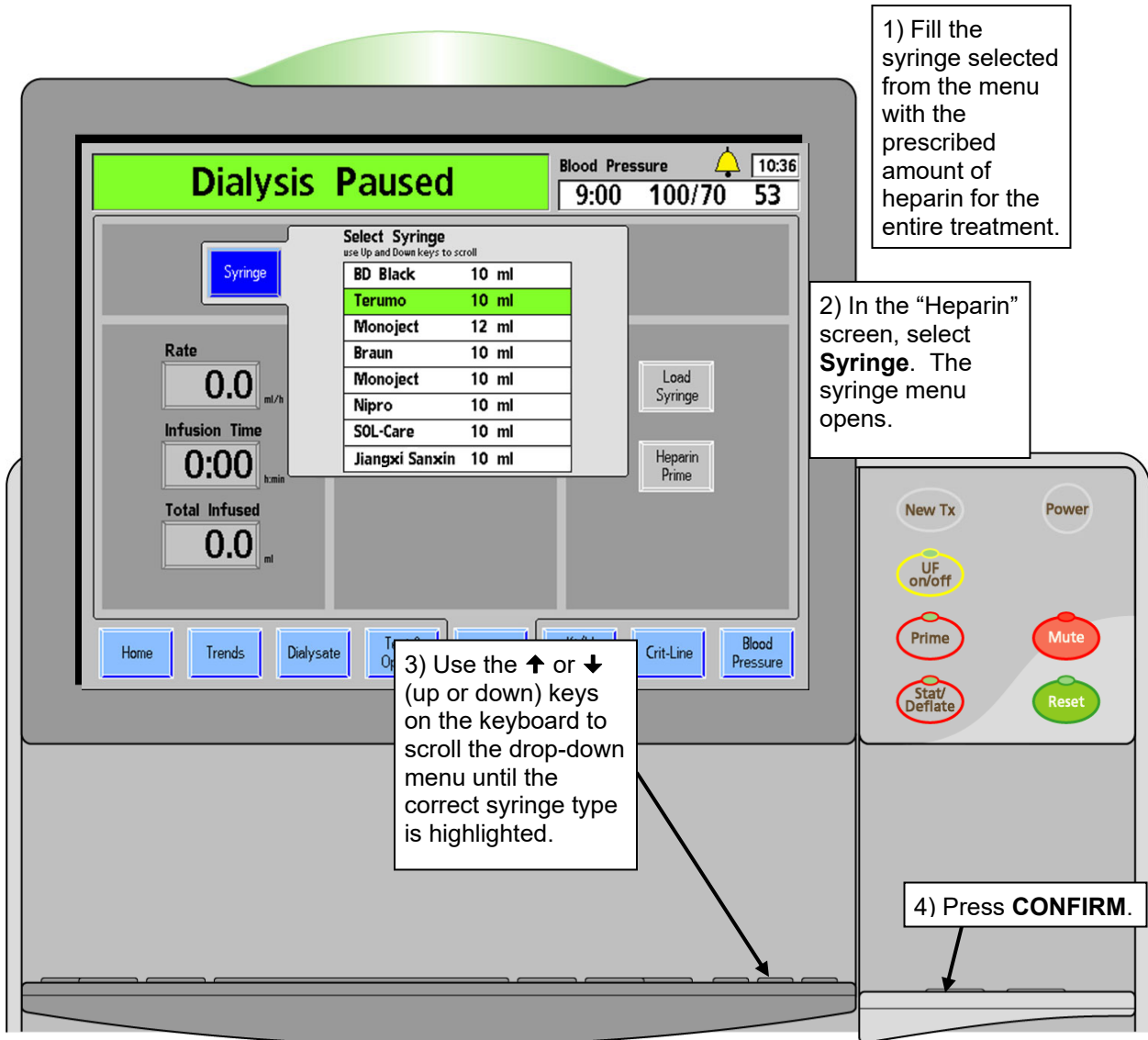

Figure 51 – The Syringe Subscreen on the Heparin Screen (showing functional software version 2.81 or later)

5. Select the **Load Syringe** button, then press the **CONFIRM** key. The heparin pump carriage fully retracts.



Warning! Make sure that there is sufficient heparin for the bolus and subsequent heparin infusion. Do not load the syringe beyond the prescribed amount.

6. Pull back one of the barrel lock tabs and press the barrel of the syringe into place. Slide the barrel wings of the syringe into the wings slot on the pump module. With the barrel in place, release the barrel lock tab (see Figure 52).
7. Squeeze the carriage latch to open the plunger holder and allow the carriage assembly to move freely. To prevent backup of blood into the syringe, be sure to slide the carriage upward until it is firmly seated against the syringe plunger.
8. Release the carriage latch and allow the plunger lock tabs to clamp the plunger in place securely.

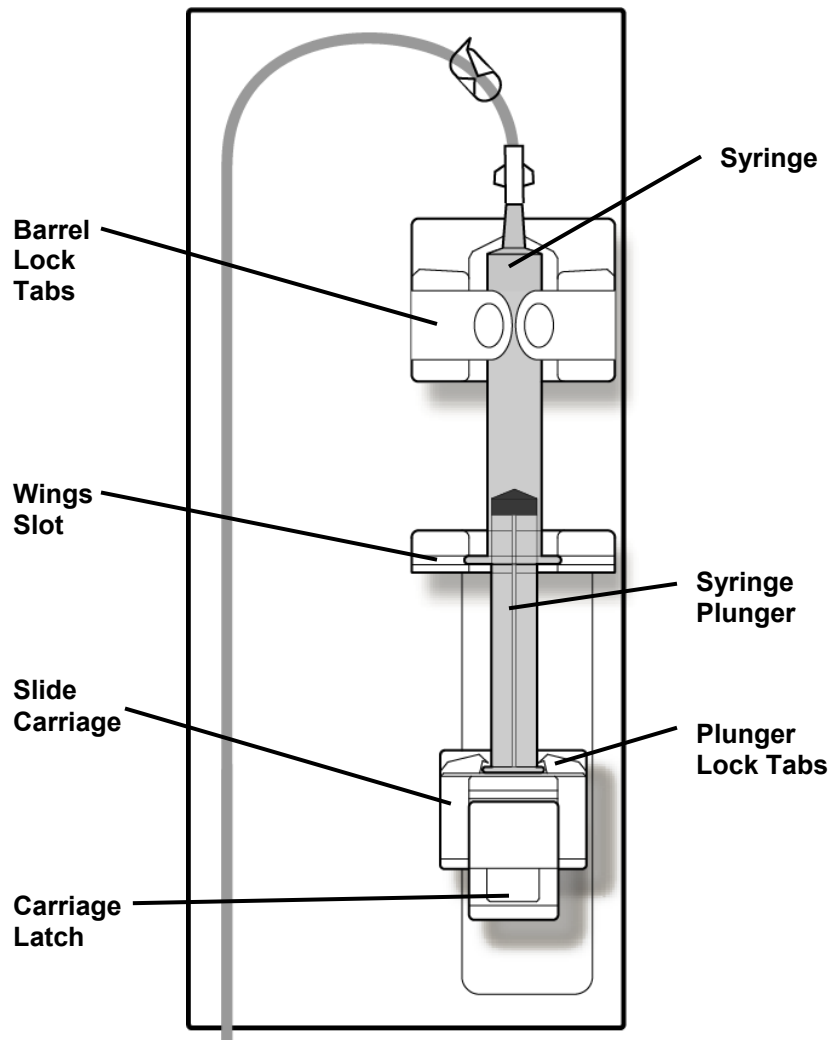

Figure 52 – The 2008T Heparin Pump Module with Syringe Loaded and Connected

9. Connect the syringe to the heparin line and unclamp the heparin line.
10. Select the **Heparin Prime** button, then press and hold the **CONFIRM** key. As the carriage moves upward, observe the heparin as it travels from the syringe through the heparin line.
11. When the air has been cleared from the heparin line, release the **CONFIRM** key. The pump will stop.



Warning! Clamp the heparin line closest to the “T” connection during recirculation if using reuse dialyzer.

12. In the “Heparin” screen, set the treatment parameters for Rate, Infusion Time, and Bolus as described in Figure 50 – The Heparin Screen on page 107.

The heparin administration system is now ready for patient treatment.



Warning! The heparin pump is to be used only under positive pressure conditions. Under negative pressure conditions, excessive heparin may be infused.



Warning! When the heparin pump is used to administer low heparin infusion rate prescriptions, an infusion delay or intermittent infusion may occur. This may occur due to pressure changes in the bloodlines during the infusion process.



Note: The **Heparin** button is colored green when the heparin delivery system is running (functional software version 2.34 or later).

Test & Options Screen Settings

The “Test & Options” screen is divided into two distinct sections. The left side of the screen is used to initiate the self-test and show the results (see “Testing the 2008T Hemodialysis Machine” on page 72). The right side of the screen is available to set the machine for various treatment options. Refer to the table below for descriptions of the purpose and functions of each button.

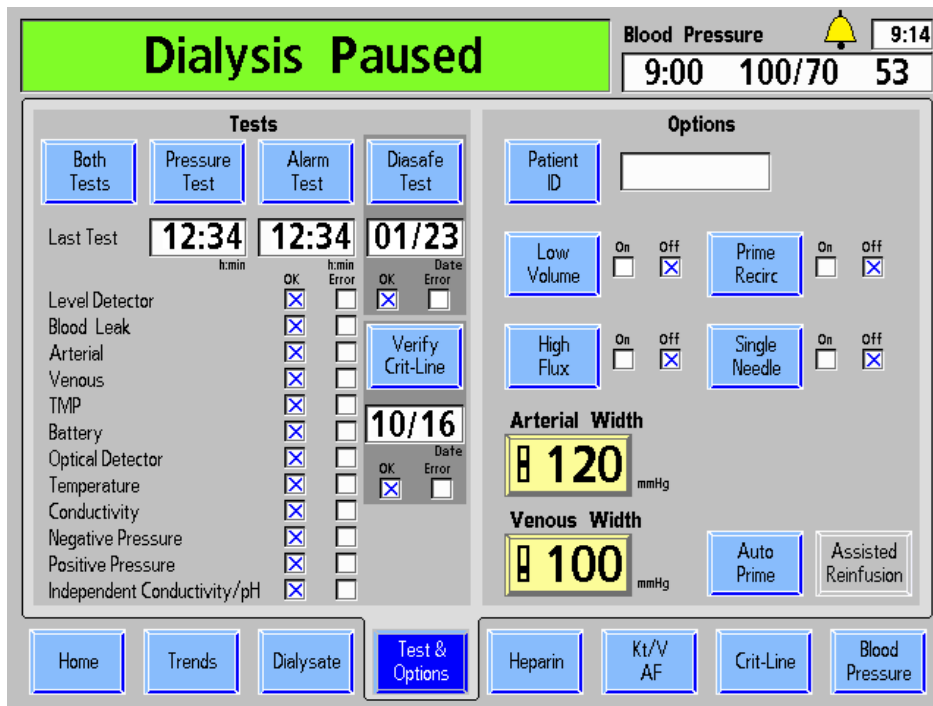
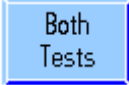
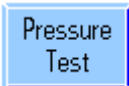



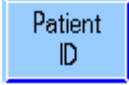









Figure 53 – The Test & Options Screen (showing functional software version 2.72 or later with bibag)

The following table describes the operator-programmable features in the “Test & Options” screen.

Table 20 – Test & Options Screen Buttons

Button	Function
	This test will initiate both the pressure holding tests (PHT) and the alarm test functions. The date of the last test is displayed below the button.
	The user can choose to do a Pressure Holding Test with this button. The date of the last test is displayed below the button.

Button	Function
	<p>The user can choose to do the Alarm Test with this button. The date of the last test is displayed below the button.</p>
	<p>The user can choose to do the Diasafe Test with this button. The date of the last test and test result is displayed below the button.</p>
	<p>The Verify Crit-Line button is used to manually verify the optional CLiC device. The date of the last test and test result is displayed below the button. To verify the CLiC device manually, clip the device on its verification filter, select the Verify Crit-Line button, and press the CONFIRM key. When an 'X' appears in the 'OK' field, the CLiC device has been successfully verified.</p> <p>If no CLiC device is attached, a red 'X' appears in the Error box. Machine operation is not affected and treatment can proceed normally.</p> <p> Note: The 2008T hemodialysis machine is set up in Service Mode to display either the "BTM BVM" screen or the "Crit-Line" screen. The Verify Crit-Line button is available from the "Test & Options" when the "Crit-Line" screen is displayed. See the "Crit-Line Screen" on page 157 for more information.</p>
	<p>Selecting the Patient ID button allows the user to enter a patient's ID in the text box located to the right of the button. The 2008T hemodialysis machine can upload treatment information to a network database for review by clinical staff using a personal computer.</p> <p> Note: If a PatientCard is being used with the treatment, the ID number saved on the PatientCard will be displayed here and the button will be unavailable to change it.</p>
	<p>The Low Volume button activates treatment settings specific to patients weighing between 20 and 40 kilograms (44 to 88 lbs.). The selection is indicated by an X in the On or Off box. See page 115 for more information.</p> <p> Note: The Low Volume button is temporarily unavailable (grayed-out) if a blood pressure reading is in progress. After the reading is completed, the option will once again be available to set.</p> <p>This button is unavailable to set if blood is sensed or the Tx Clock is running.</p> <p>The Low Volume button will also be unavailable for the rest of the treatment if any UF parameter has already been changed (UF Goal, UF Time, UF Rate) or if the UF Removed button is not zero. To set the 'Low Volume' option, press and confirm the New Tx key to initiate a new treatment. The option will also become available again after performing a long power down or running a rinse program.</p>

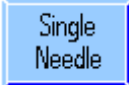
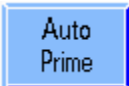
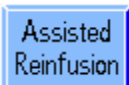
Button	Function
	<p>The High Flux button selects parameters for the use of a high flux dialyzer for treatment. The selection is indicated by an X in the On or Off box.</p> <p> Warning! It is essential that the 2008T hemodialysis machine's balancing system is operating properly. The machine must successfully complete a Pressure test before each treatment, especially when using high-flux dialyzers. For more information, See "Testing the 2008T Hemodialysis Machine" on page 72.</p>
<p>Arterial Width</p> 	<p>The Arterial Width button allows the selection of three different ranges for the arterial pressure alarm (120, 160, and 200 mmHg).</p> <p>Note: These options will only be available if set to "User Selectable" in the Service Mode "Options" screen.</p>
<p>Venous Width</p> 	<p>The Venous Width button allows the selection of four different ranges for the venous pressure alarm (100 asymmetric limits, 120, 160, and 200 mmHg). The asymmetric limit will close the lower venous limit after a time delay for stabilization.</p> <p>Note: These options will only be available if set to "User Selectable" in the Service Mode "Options" screen.</p>
	<p>Runs the UF pump at preselected UF goal and time while recirculating. UF goal and Time are entered in the Service Mode.</p>
	<p>The Single Needle button prepares the machine for single-needle dialysis treatment. For more information on single-needle dialysis treatment, see Appendix A on page 280.</p>
	<p>The Auto Prime button displays a guided process to automatically prime the bloodlines. For more information on the Auto Prime feature, see page 66.</p>
	<p>The Assisted Reinfusion button displays a guided process to aid in returning the patient's blood at the end of treatment. For more information on the Assisted Reinfusion feature, see page 173.</p>

Low Volume Dialysis

The Low Volume option is for patients weighing between 20 and 40 kilograms (44 to 88 lbs.). This option automatically lowers blood pressure cuff ranges, pressure monitoring ranges, UF rates, and blood flow rates, and it restricts the allowable blood pump segment sizes to less than 8 mm, see Table 21 below for more information.



Warning! When using Low Volume bloodlines, the blood pump must be set for the correct inner diameter of the pump segment.

Note: When bloodlines with a diameter of less than 6.4 mm are used, the Auto Prime and Assisted Reinfusion options are not available.

Table 21 – Low Volume Settings

Available Blood Pump Segments	Blood Flow Rate
2.6 mm	6 – 86 ml/min
4.8 mm	10 – 274 ml/min
6.35 mm (displayed as 6.4)	20 – 465 ml/min
Blood Pressure Alarm Limits	Range
Systolic (upper)	90 – 160 mmHg
Systolic (lower)	70 – 130 mmHg
Diastolic (upper)	60 – 100 mmHg
Diastolic (lower)	40 – 80 mmHg
Pulse (upper)	80 – 200 BPM
Pulse (lower)	40 – 180 BPM
Cuff Inflation Pressure	120 – 210 mmHg, default Auto setting begins at 120 mmHg and for subsequent measurements inflates to approximately 30 mmHg above last systolic reading
Blood Circuit Pressure	Monitoring Range
Arterial	-260 to +300 mmHg with 3 automatically set alarm limit window widths (± 40 , ± 60 , and ± 80) mmHg centered around set pressure (Single Needle ± 80 mmHg)
Venous	-60 to +300 mmHg with 3 fixed window limit values of ± 40 , ± 60 , and ± 80 mmHg of set pressure (Single Needle ± 80 mmHg)
Ultrafiltration	Range
UF Rate	0 – 1000 ml/hr, default 30 ml/hr
Maximum UF Rate (set in Service Mode)	500, 600, 700, 800, 900, or 1000 ml/hr

To set the ‘Low Volume’ option: select the **Low Volume** button on the “Test & Options” screen until a gray ‘X’ appears in the ‘On’ check box. Press the **CONFIRM** key to confirm the selection. A blue ‘X’ will appear in the ‘On’ check box next to the button when the option is selected. The blood pressure module uses a lower, initial-inflation pressure when the Low Volume option selected (see the Blood Pressure Module machine specifications on page 372).

Blood Pressure Screen Settings

The “Blood Pressure” screen works in conjunction with the blood pressure module. The operator sets the inflation pressure of the cuff, the frequency at which the tests are to be performed, and the upper and lower limits for the various blood pressure and pulse alarms. The Blood Pressure Module automatically takes the patient’s blood pressure at each set interval. The pulse and blood pressure readings are both displayed in a table on the left side of the Blood Pressure screen (see Figure 54 on page 116). The blood-pressure history is also graphically displayed here and in the “Trends” screen. The time and results of the last blood pressure reading is always available in the Dialogue Box located in the upper right corner of any screen.



Note: Only readings taken while the Tx Clock is running will be displayed on the graph. All readings will be shown in the table. If a blood pressure reading is started manually with the **Stat/Deflate** key, the reading will be preceded with “M” in the data table.

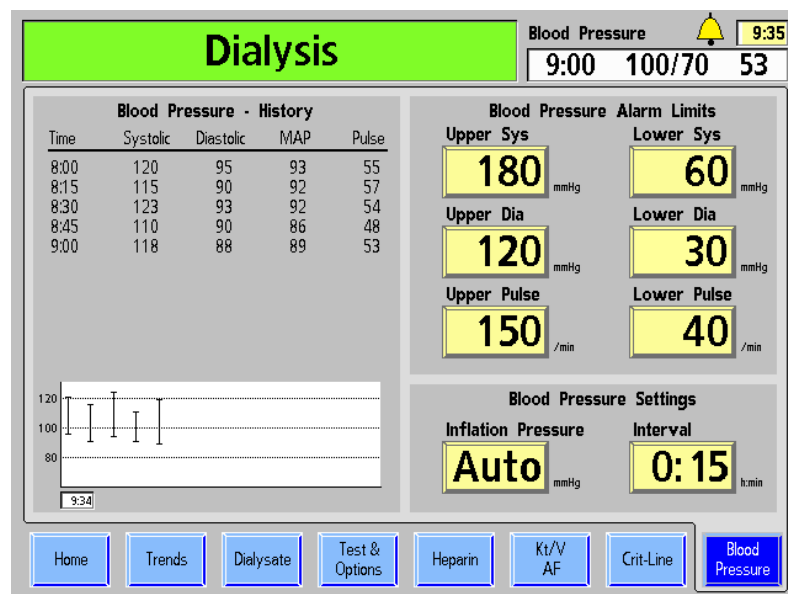

Figure 54 – Blood Pressure Screen

The blood pressure alarm limits are set in the upper, right side of the screen. The upper and lower alarm limits for pulse rate and systolic and diastolic blood pressures are set here. If a pressure value is outside the set alarm limits, the machine sounds a series of short, intermittent beeps.

The lower right portion of the screen contains two buttons for setting the inflation pressure of the cuff, and the frequency at which it will inflate.



Caution: Do not squeeze the blood pressure cuff when deflating it. Squeezing the blood pressure cuff may damage the machine's internal blood pressure module.







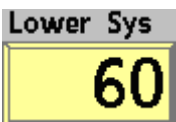
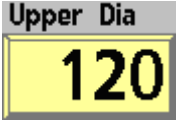
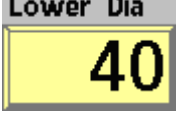
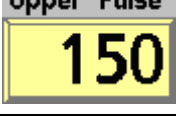
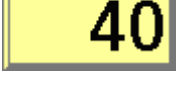

Note: The blood pressure module is not designed to replace the periodic observation of the patient by the clinical staff. The clinical staff should review all blood pressure readings.

Blood Pressure Screen Buttons

The following table contains a list of treatment parameters to set in the “Blood Pressure” screen. To enter a treatment parameter, see “Entering a Parameter” on page 80.

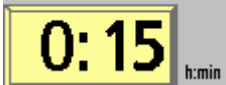
Table 22 – The Blood Pressure Screen Buttons

Button	Function
	The Upper Sys button is used to set the upper alarm limit for systolic blood pressure. The programmable range for Upper Systolic is 80 – 250 mmHg for standard patients and 90 – 160 mmHg for Low Volume patients. An alarm event occurs when the patient’s systolic pressure reaches or exceeds the set value.
	The Lower Sys button is used to set the lower alarm limit for systolic blood pressure. The programmable range for Lower Systolic is 60 – 150 mmHg for standard patients and 70 – 130 mmHg for Low Volume patients. An alarm event occurs when the patient’s systolic pressure reaches or falls below the set value.
	The Upper Dia button is used to set the upper alarm limit for diastolic blood pressure. The programmable range for Upper Diastolic is 80 – 200 mmHg for standard patients and 60 – 100 mmHg for Low Volume patients. An alarm event occurs when the patient’s diastolic pressure reaches or exceeds the set value.
	The Lower Dia button is used to access the lower alarm limit for diastolic blood pressure. The programmable range for Lower Diastolic is 40 – 150 mmHg for standard patients and 40 – 80 mmHg for Low Volume patients. An alarm event occurs when the patient’s diastolic pressure reaches or falls below the set value.
	The Upper Pulse button is used to set the upper alarm limit for pulse rate. The programmable range for Upper Pulse is 80 – 200 beats/min for both standard and Low Volume patients. An alarm event occurs when the patient’s pulse rate reaches or exceeds the set value.
	The Lower Pulse button is used to set the lower alarm limit for pulse rate. The programmable range for Lower Pulse is 40 – 140 beats/min for standard patients and 40 – 180 beats/min for Low Volume patients. An alarm event occurs when the patient’s pulse rate reaches or falls below the set value.

Button	Function
<p>Inflation Pressure</p> 	<p>The Inflation Pressure button is used to set the initial inflation pressure for the blood pressure cuff.</p> <p>The default setting is “Auto” in which the cuff will initially inflate to 180 mmHg for standard patients and 120 mmHg for Low Volume patients. For all subsequent readings, the cuff will inflate to approximately 50 mmHg above the last systolic pressure reading for standard patients and approximately 30 mmHg for Low Volume patients.</p> <p>The minimum inflation pressure setting is 120 mmHg for both standard and Low Volume patients. The maximum inflation pressure setting is 280 mmHg for standard patients and 210 mmHg for Low Volume patients.</p>
<p>Interval</p>  <p>Clock Time</p> 	<p>The Interval/Clock Time button is used to set the frequency (hr:min) at which the patient’s blood pressure will be read and recorded.</p> <p>This interval may be set up in the Service Mode (see page 316 for more information) in one of two ways:</p> <ul style="list-style-type: none"> • Interval – Blood pressure readings are taken at the selected interval time between readings based on the start of treatment. If this option is selected, the heading over the button will read “Interval”. • Clock Time – Blood pressure readings are taken every 5, 10, 15, 20, 30, or 60 minutes based on the local time (see below). If this option is selected, the heading over the button will read “Clock Time”. <p> Warning! Too frequent measurements can cause injury to the patient due to blood flow interference. During patient treatment, regularly check that operation of the automated blood pressure monitoring subsystem does not result in prolonged impairment of the patient's blood circulation.</p>
	<p>On the “Blood Pressure” screen only, the local time may be set by selecting the clock in the upper right corner of the Dialogue Box. The ↑ or ↓ (up or down) arrow keys on the keyboard may then be used to change the time.</p>



Note: Using cuff tubing longer than 10 feet may result in erroneous blood pressure readings.

At this point, all treatment parameters should have been entered and it is time to connect the patient and begin the treatment; turn to page 135 to continue.

Using the Default Parameters Screen

The “Default Parameters” screen (functional software version 2.72 or later) can be used to conveniently access most treatment parameters in one place. This screen (see Figure 55) is available when the Service Mode ‘Default Rx Screen’ option is set to ‘Yes’ and no PatientCard is used. To access the “Default Parameters” screen, press the **New Tx** key and, when prompted, press the **CONFIRM** key. All listed parameters are set to the default values and the following screen will be displayed:

Default Parameters		Press Done to transfer default prescription to dialysis screens	
Dialysate Settings	Concentrate 08-2251-CA 45X Base Na+ 138 mEq/l Bicarbonate 32 mEq/l Temperature 37 °C Dialysate Flow 800 ml/min SVS Profile None Start Na+ --- mEq/l SVS-Time -:- h:min	UF Settings	Total Weight --- kg Subtract Weight 0 kg Current Weight --- kg Dry Weight --- kg Additional Vol. 0 ml UF Goal 3000 ml UF Time 3:00 h:min UF Rate 1000 ml/h UF Profile None
Heparin Settings	Heparin Rate 0.0 ml/hr Infusion Time 0:00 h:min Bolus 0.0 ml	Blood Pump Rate <div style="border: 1px solid black; padding: 5px; display: inline-block;">300</div> ml/min	BV Alert Level <div style="border: 1px solid black; padding: 5px; display: inline-block;">-15</div> %
BP Settings	Upper Sys 180 mmHg Lower Sys 60 mmHg Upper Dia 120 mmHg Lower Dia 30 mmHg Upper Pulse 150 /min Lower Pulse 40 /min Inflation Pres Auto mmHg Interval 0:15 h:min	OLC Volume <div style="border: 1px solid black; padding: 5px; display: inline-block;">0.0</div> L	O₂ Alert Level <div style="border: 1px solid black; padding: 5px; display: inline-block;">89</div> %
		Target Kt/V <div style="border: 1px solid black; padding: 5px; display: inline-block;">0.0</div> Single Pool	<div style="border: 2px solid blue; border-radius: 50%; width: 40px; height: 40px; display: flex; align-items: center; justify-content: center; margin: 0 auto;"> Done </div>

Figure 55 – The Default Parameters Screen After Confirming a New Tx



Warning! The values shown in pictures here are for example only. Parameters must be entered as prescribed by the patient’s physician. Failure to enter correct parameters could result in serious injury or death.

If any treatment parameters need to be changed or if they have not been entered yet, they can be entered from this “Default Parameters” screen. To instead enter the parameters screen-by-screen using each of the eight screen-buttons at the bottom of the Dialysis program screens, turn to page 78.

For general instructions on how to enter a treatment parameter, see page 80.

Turn to the next page to enter the dialysate prescription.



Note: The “Default Settings” screens can be exited at any time without saving changes by pressing the **Escape** key. Selecting the **Done** button and confirming the changes (see page 125) transfers the prescription to the various dialysis screens used during treatment.

Entering Dialysate Settings on the “Diaysate Defaults” screen:

Each of the editable dialysate parameters are displayed to the right of the **Dialysate Settings** screen-button. To edit the dialysate parameters, select the **Dialysate Settings** screen-button. The “Dialysate Defaults” screen will be displayed (see Figure 56 below).

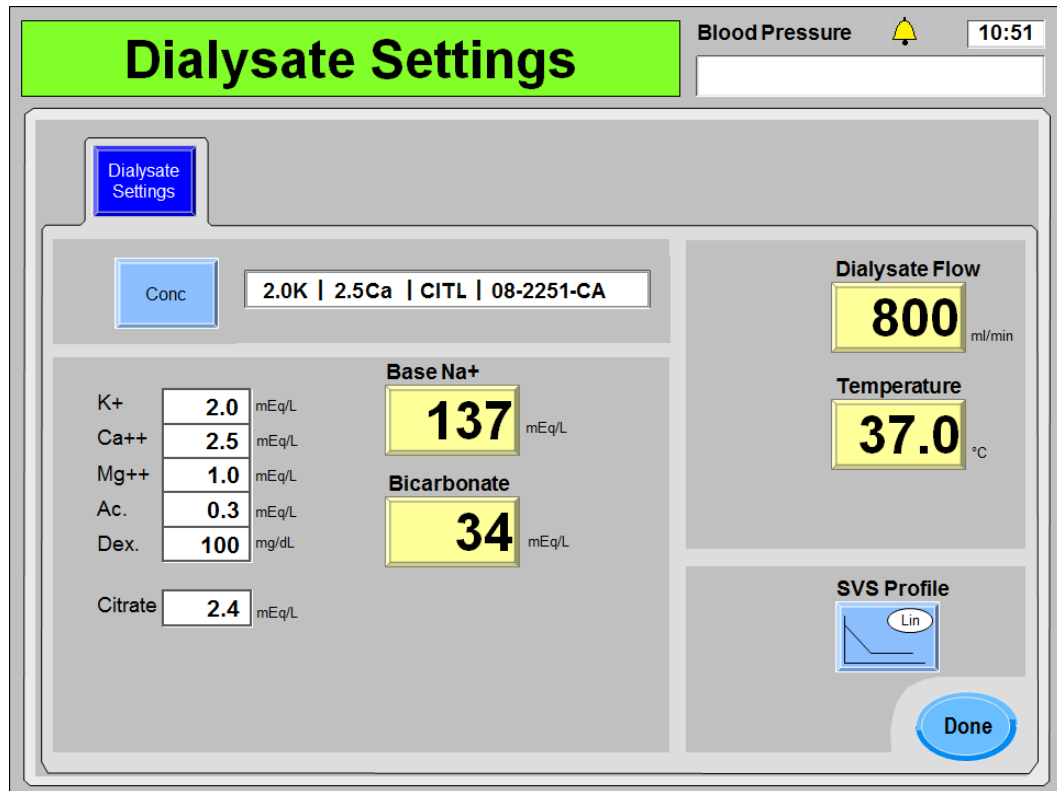

Figure 56 – The Dialysate Defaults Subscreen

The “Dialysate Defaults” subscreen groups dialysate-related parameters set on the “Dialysate” and “Home” screens.

- For a description of the **Conc**, **Base Na+**, and **Bicarbonate** buttons, see page 82.
- For a description of the **Dialysate Flow** and **Temperature** buttons, see page 93.
- For a description of the **SVS Profile** button (if enabled), see page 103.

After entering the dialysate prescription, select the **Done** button to return to the main “Default Parameters” screen. There the **Heparin Settings** button may be selected to enter the heparin-related parameters. Turn to the next page to enter the heparin prescription.

Entering Heparin Settings on the “Heparin Defaults” screen:

Each of the editable heparin parameters are displayed to the right of the **Heparin Settings** screen-button. To edit the dialysate parameters, select the **Heparin Settings** screen-button. The “Heparin Defaults” screen will be displayed (see Figure 57 below).

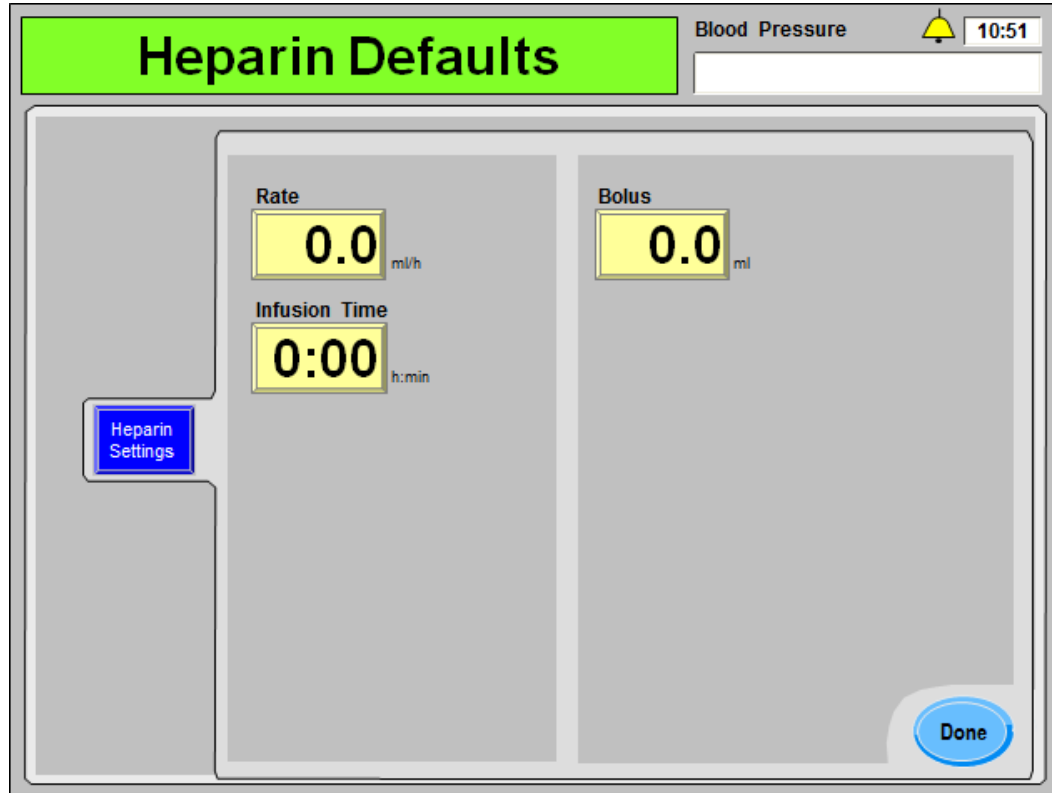

Figure 57 – The Heparin Defaults Subscreen

The “Heparin Defaults” subscreen shows the heparin-related parameters set on the “Heparin” screen. For a description of the **Rate**, **Infusion Time**, and **Bolus** buttons, see page 107.

The heparin syringe is not a prescribed item and should be individually selected on the “Heparin” screen when loading the heparin syringe during treatment setup.



Warning! The correct syringe type must be selected to ensure an accurate infusion.

After entering the heparin prescription, select the **Done** button to return to the main “Default Parameters” screen. There the **BP Settings** button may be selected to enter the blood pressure-related parameters. Turn to the next page to enter the blood pressure prescription.

Entering BP Settings on the “BP Defaults” screen:

Each of the editable blood pressure parameters are displayed to the right of the **BP Settings** screen-button. To edit the blood pressure parameters, select the **BP Settings** screen-button. The “BP Defaults” screen will be displayed (see Figure 58 below).



Note: Values entered here will revert to machine defaults when the **New Tx** key is pressed. To enter BP defaults that will not change when the **New Tx** key is pressed, see page 357.

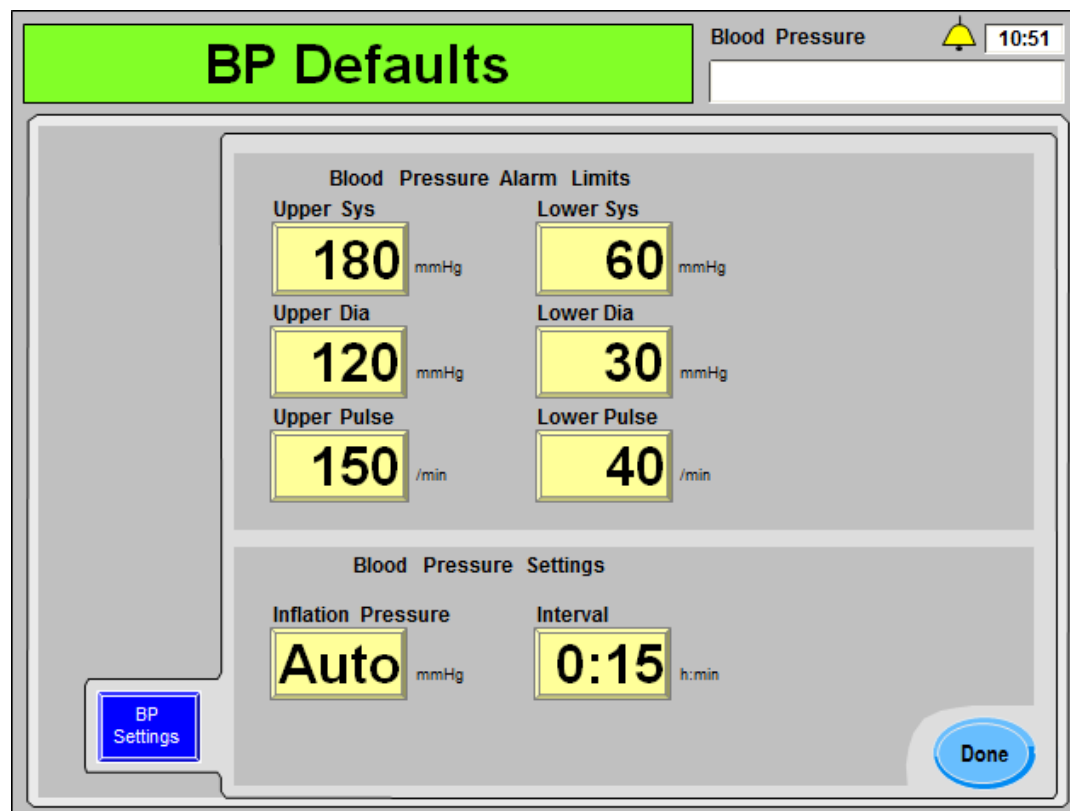

Figure 58 – The BP Defaults Subscreen

The “BP Defaults” subscreen shows the blood pressure-related parameters set on the “Blood Pressure” screens. For a description of these buttons, see page 116.



Note: The name of the parameter button displayed to the right of the **Inflation Pressure** button depends on the ‘Auto BP Reading’ Service Mode option, see page 118 for more information.

After entering the blood pressure prescription, select the **Done** button to return to the main “Default Parameters” screen. There the **UF Settings** button may be selected to enter the UF-related parameters. Turn to the next page to enter the ultrafiltration prescription.

Entering UF Settings on the “UF Defaults” screen:

Each of the editable dialysate parameters are displayed to the right of the **UF Settings** screen-button. To edit the ultrafiltration (UF) parameters, select the **UF Settings** screen-button. The “UF Defaults” screen will be displayed (see Figure 59 below).

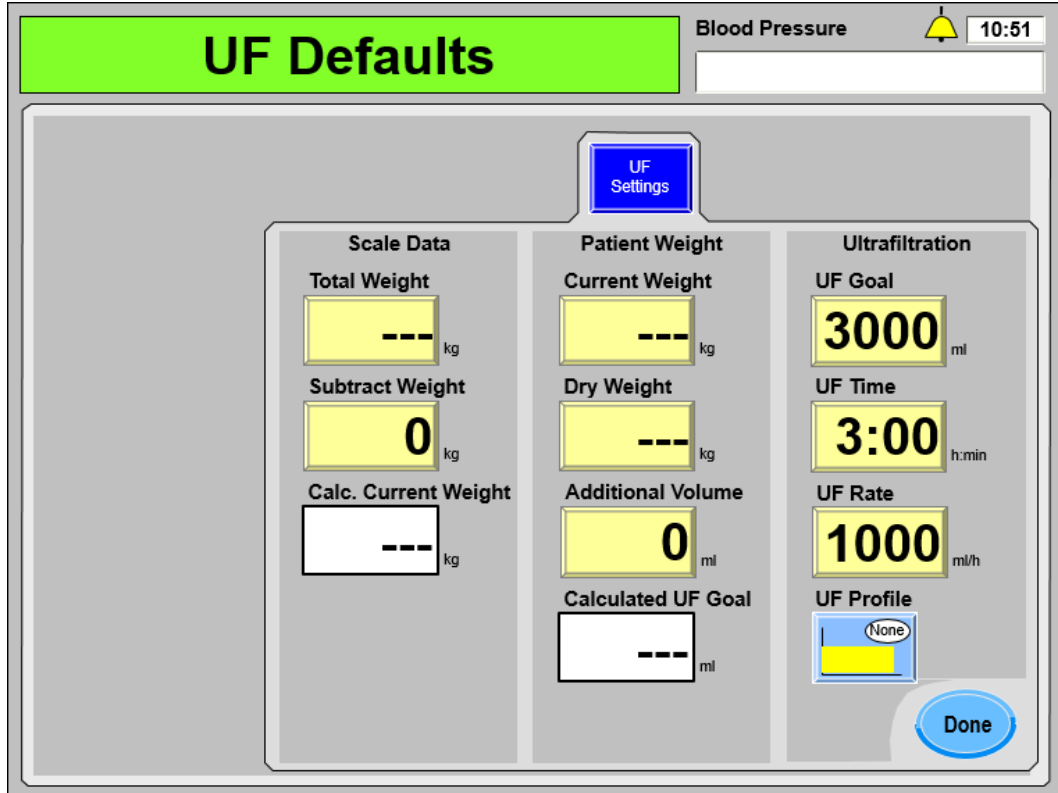



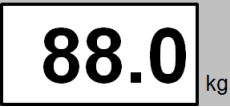



Figure 59 – The UF Defaults Subscreen

The “UF Defaults” subscreen groups UF-related parameters set on the “Home” screen with parameters accessible only in these “Default Parameters” screens.

- For a description of the **UF Goal**, **UF Time**, and **UF Rate** buttons, see page 93.
- For a description of the **UF Profile** button, see page 98.

Table 23 – Features Unique to the UF Settings Screen

Feature	Function
	Total Weight—This is the total weight in kilograms when the patient was weighed with a scale before the treatment. This value may include the patient’s clothing, wheelchair, gurney, or other equipment.

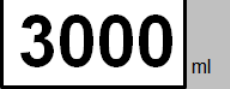
Feature	Function
<p>Subtract Weight</p> 	<p>Subtract Weight)—This is the weight in kilograms of the patient’s clothing, wheelchair, gurney, or other equipment that will be subtracted from the total weight. The calculated value is then displayed in the Calc. Current Weight meter-box below.</p>
<p>Calc. Current Weight</p> 	<p>Calc. Current Weight—This meter box displays the current weight calculated by subtracting the Subtract Weight value from the Total Weight value. This calculated value will carry over to the yellow Current Weight parameter-button at the top of the middle column. Editing the yellow Current Weight parameter-button will not change the calculated UF goal in this meter box.</p>
<p>Current Weight</p> 	<p>Current Weight—This is the weight in kilograms when the patient was weighed with a scale before the treatment. This value can be adjusted independently from the calculated current weight (see above).</p>
<p>Dry Weight</p> 	<p>Dry Weight—This is the prescribed, ideal weight (in kilograms) for the patient after ultrafiltration has been performed.</p> <p> Note: If the Dry Weight is less than 40 kg, the ‘Low Volume’ option on the “Test & Options” screen will automatically be set to ‘Yes’. For more information about Low Volume dialysis, see page 115.</p>
<p>Additional Volume</p> 	<p>Additional Volume—This is the amount of fluid (in milliliters) that is added to difference between the current weight and dry weight to calculate the UF goal. This value could include the saline rinse back volume or the volume the patient may drink during treatment.</p>
<p>Calculated UF Goal</p> 	<p>Calculated UF Goal—This meter box displays the ultrafiltration goal (in milliliters) calculated by subtracting the dry weight from the current weight and adding the additional volume. This value will carry over to the yellow UF Goal parameter-button at the top of the middle column (and on the “Home” screen). Editing the yellow UF Goal parameter-button will not change the calculated UF goal in this meter box.</p>

After entering the ultrafiltration prescription, select the **Done** button to return to the main “Default Parameters” screen. There the remaining parameter-buttons may be selected. Turn to the next page to finish entering the prescription.

Setting the Remaining Parameters on the Default Parameters Screen:

The remaining parameters to be set on the “Default Parameters” screen are located in the lower right corner.

Default Parameters		Press Done to transfer default prescription to dialysis screens	
Dialysate Settings	Concentrate 08-2251-CA 45X Base Na⁺ 138 mEq/l Bicarbonate 32 mEq/l Temperature 37 °C Dialysate Flow 800 ml/min SVS Profile Lin Start Na⁺ 140 mEq/l SVS-Time 3:00 h:min	UF Settings	Total Weight 106.0 kg Subtract Weight 18.0 kg Current Weight 88.0 kg Dry Weight 85.0 kg Additional Vol. 0 ml UF Goal 3000 ml UF Time 3:00 h:min UF Rate 1000 ml/h UF Profile None
Heparin Settings	Heparin Rate 1.0 ml/hr Infusion Time 2:30 h:min Bolus 1.0 ml	Blood Pump Rate <div style="border: 1px solid black; padding: 5px; display: inline-block;">300</div> ml/min	BV Alert Level <div style="border: 1px solid black; padding: 5px; display: inline-block;">-15</div> %
BP Settings	Upper Sys 180 mmHg Lower Sys 60 mmHg Upper Dia 120 mmHg Lower Dia 30 mmHg Upper Pulse 150 /min Lower Pulse 40 /min Inflation Pres Auto mmHg Interval 0:15 h:min	OLC Volume <div style="border: 1px solid black; padding: 5px; display: inline-block;">30.0</div> L	O₂ Alert Level <div style="border: 1px solid black; padding: 5px; display: inline-block;">89</div> %
		Target Kt/V <div style="border: 1px solid black; padding: 5px; display: inline-block;">0.0</div> <small>Single Pool</small>	<div style="border: 2px solid blue; border-radius: 50%; width: 40px; height: 40px; display: inline-block; text-align: center; vertical-align: middle;">Done</div>

Figure 60 – Setting the remaining parameters on the Default Parameters Screen

- For a description of the **Blood Pump Rate** button, see page 96.
- For a description of the **OLC Volume** and **Target Kt/V** buttons, see page 147.
- If applicable, see Table 32 on page 159 for descriptions of the Crit-Line **BV Alert Level** and **O₂ Alert Level** button or page 156 for the BVM (**BV**) **Alert Level** button.

Saving and transferring the “Default Parameters” screen settings:

After entering the remaining prescription items, select the **Done** button to exit the main “Default Parameters” screen. This will automatically transfer the parameters to the various dialysis screens used during treatment.

The “Dialysate” screen will then be displayed as usual and the concentrate must be confirmed. Treatment options like Single Needle and High Flux dialyzers may be set on the “Test & Options,” see page 112 for more information.

At this point, all treatment parameters should have been entered and it is time to connect the patient and begin the treatment; turn to page 135 to continue.

Using the PatientCard

When a blank PatientCard is inserted into the optional PatientCard Reader (see page 38), the “New Patient Information” screen is displayed (see Figure 61). This screen requires the operator to permanently save a patient’s ID number, first name, last name, and birthdate to a blank PatientCard. This is the only time this information is entered.



Note: If the machine does not read the PatientCard within five seconds, remove the PatientCard and reinsert it to try again.

Note: The Prescription screens can be exited at any time without saving changes by removing the PatientCard or pressing the **Escape**.

Figure 61 – The New Patient Information Screen

Enter the following information to continue:

- Select the **Patient ID** button, use the keyboard to type the desired patient ID number, and press the **CONFIRM** key. The ID number may be a maximum of ten characters.
- Select the **First Name** button, use the keyboard to type the desired first name, and press the **CONFIRM** key. The name may be a maximum of fifteen characters.
- Select the **Last Name** button, use the keyboard to type the desired last name, and press the **CONFIRM** key. The name may be a maximum of fifteen characters.
- Select the **Birthdate** button, use the keyboard to type the desired birthdate, and press the **CONFIRM** key. Use the date format mm/dd/yyyy (where ‘m’ is for month, ‘d’ is for day, and ‘y’ is for year).

When the information has been correctly entered, select the **Save** button to permanently save this information to the blank PatientCard and display the next screen.



Note: After the **Save** button has been selected, the patient ID, first name, last name, and birthdate can no longer be edited. If a change to these items must be made, another new, blank PatientCard must be inserted to display this screen again.

Verifying Patient Information

Every time a PatientCard with a saved Patient ID is inserted into the PatientCard Reader, the “Patient Information” screen is displayed (see Figure 62). This screen displays the Patient ID number, preferred name of the patient (as entered as ‘First Name’ and ‘Last Name’ on the “New Patient Information” screen, see Figure 61), and the birthdate. The patient’s name and birthdate are displayed only on this screen when using the PatientCard.

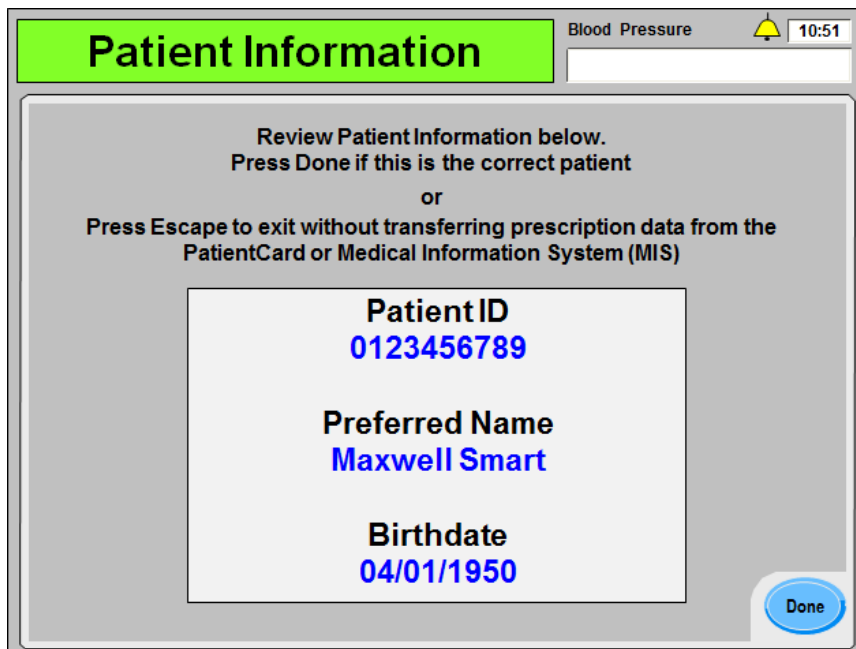

Figure 62 – The Patient Information Screen

Verify the information displayed here matches the patient then select the **Done** button to display the next screen. The 2008T hemodialysis machine’s PatientCard Reader will attempt to contact the clinic’s Medical Information System (MIS). If no MIS is available in the clinic, press the **Escape** key to cancel and a pop-up message will prompt the operator to press the **Confirm** key to instead download the last prescription saved on the PatientCard. If a prescription for this patient is available on the PatientCard, the 2008T hemodialysis machine will automatically download it and display it on the “Prescription” screen. If no prescription yet exists, a default prescription will be displayed. Continue to the next page.



Note: Pressing the **Escape** key will exit this screen and not transfer the displayed patient’s prescription (if available) to the 2008T hemodialysis machine.

Note: Keep the PatientCard in the PatientCard Reader slot during the treatment in order to save the treatment history and retain any changes made during treatment.

Note: If the ‘Low Volume’ option on the “Test & Options” screen is set to ‘On’ but the current treatment will be for a patient weighing over 40 kg, be sure to set the ‘Low Volume’ option on the “Test & Options” screen to ‘OFF’ before inserting the PatientCard.

The Prescription Screen

The “Prescription” screen (functional software version 2.72 or later) can be used to conveniently access most treatment parameters in one place. This screen (see Figure 63) is displayed after verifying the patient’s ID, name, and birthdate when using the PatientCard. The Patient ID will then be displayed in the Dialogue Box on all Prescription subscreens when using the PatientCard. Verify again that the displayed Patient ID matches the patient. If the patient’s prescription has been previously saved to the PatientCard and no changes are required, select the **Done** button and turn to page 135 to begin connecting the patient.

Prescription		Patient ID 0123456789	
Dialysate Settings	Concentrate 08-2251-CA 45X Base Na+ 138 mEq/l Bicarbonate 32 mEq/l Temperature 37 °C Dialysate Flow 800 ml/min SVS Profile Lin Start Na+ 140 mEq/l SVS-Time 3:00 h:min	UF Settings	Total Weight 106.0 kg Deduct Weight 18.0 kg Current Weight 88.0 kg Dry Weight 85.0 kg Additional Vol. 0 ml UF Goal 3000 ml UF Time 3:00 h:min UF Rate 1000 ml/h UF Profile None
Heparin Settings	Heparin Rate 1.0 ml/hr Infusion Time 2:30 h:min Bolus 1.0 ml	Blood Pump Rate <div style="border: 1px solid black; padding: 2px; display: inline-block;">300</div> ml/min	BV Alert Level <div style="border: 1px solid black; padding: 2px; display: inline-block;">-15</div> %
BP Settings	Upper Sys 180 mmHg Lower Sys 60 mmHg Upper Dia 120 mmHg Lower Dia 30 mmHg Upper Pulse 150 /min Lower Pulse 40 /min Inflation Pres Auto mmHg Interval 0:15 h:min	OLC Volume <div style="border: 1px solid black; padding: 2px; display: inline-block;">30.0</div> L	O₂ Alert Level <div style="border: 1px solid black; padding: 2px; display: inline-block;">89</div> %
		Target Kt/V <div style="border: 1px solid black; padding: 2px; display: inline-block;">0.0</div> <small>Single Pool</small>	<div style="border: 1px solid black; border-radius: 50%; padding: 5px; display: inline-block;">Done</div>

Figure 63 – The Prescription Screen

For general instructions on how to enter a treatment parameter, see page 80.

Turn to the next page to enter the dialysate prescription.



Warning! The values shown in pictures here are for example only. Parameters must be entered as prescribed by the patient’s physician. Failure to enter correct parameters could result in serious injury or death.



Note: The “Prescription” screens can be exited at any time without saving changes by removing the PatientCard or pressing the **Escape** key. Selecting the **Done** button and confirming the changes (see page 134) saves any changes to the PatientCard and transfers the prescription to the various dialysis screens used during treatment.

Entering Dialysate Settings on the “Prescription” screen:

Each of the editable dialysate parameters are displayed to the right of the **Dialysate Settings** screen-button. To edit the dialysate parameters, select the **Dialysate Settings** screen-button. The “Dialysate Settings” screen will be displayed (see Figure 64 below).

Dialysate Settings Patient ID 0123456789

Dialysate Settings

Conc 2.0K | 2.5Ca | CITL | 08-2251-CA

K+	2.0	mEq/L
Ca++	2.5	mEq/L
Mg++	1.0	mEq/L
Ac.	0.3	mEq/L
Dex.	100	mg/dL

Citrate 2.4 mEq/L

Base Na+ 137 mEq/L

Bicarbonate 34 mEq/L

Dialysate Flow 800 ml/min

Temperature 37.0 °C

SVS Profile Lin

Done

Figure 64 – The Prescription Screen Dialysate Settings Subscreen

The “Dialysate Settings” subscreen groups dialysate-related parameters set on the “Dialysate” and “Home” screens.

- For a description of the **Conc**, **Base Na+**, and **Bicarbonate** buttons, see page 82.
- For a description of the **Dialysate Flow** and **Temperature** buttons, see page 93.
- For a description of the **SVS Profile** button (if enabled), see page 103.

After entering the dialysate prescription, select the **Done** button to return to the main “Prescription” screen. There the **Heparin Settings** button may be selected to enter the heparin-related parameters. Turn to the next page to enter the heparin prescription.

Entering Heparin Settings on the “Prescription” screen:

Each of the editable heparin parameters are displayed to the right of the **Heparin Settings** screen-button. To edit the dialysate parameters, select the **Heparin Settings** screen-button. The “Heparin Settings” screen will be displayed (see Figure 65 below).

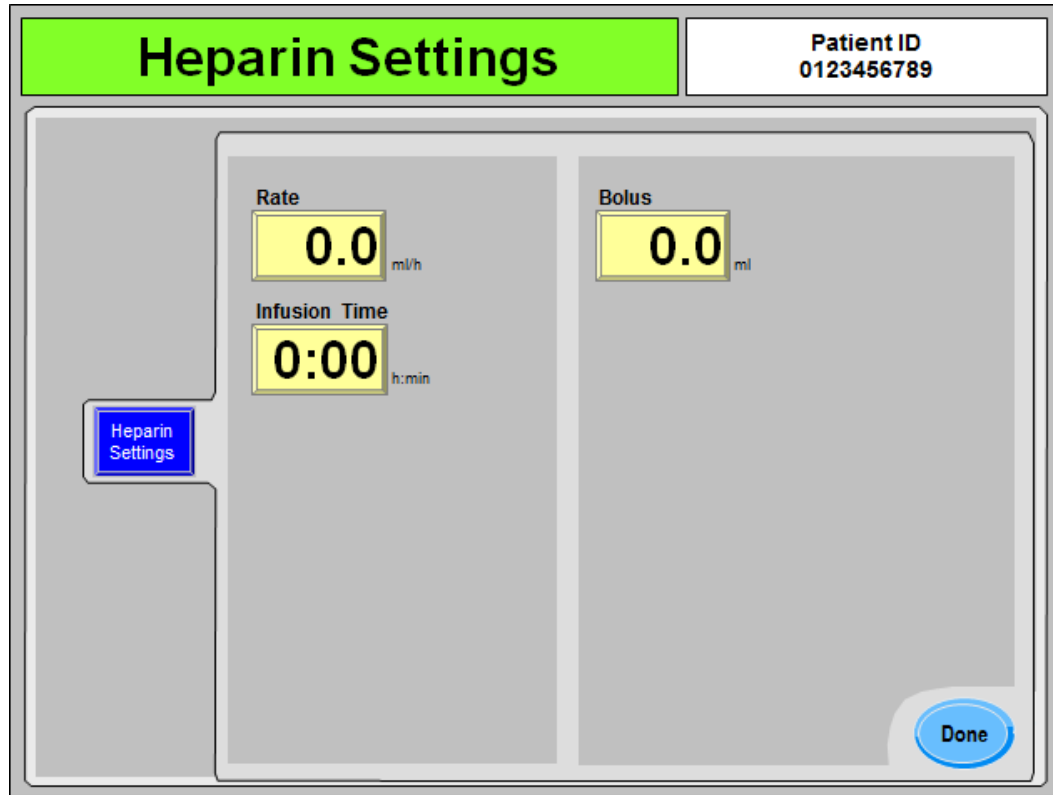

Figure 65 – The Prescription Screen Heparin Settings Subscreen

The “Heparin Settings” subscreen shows the heparin-related parameters set on the “Heparin” screen. For a description of the **Rate**, **Infusion Time**, and **Bolus** buttons, see page 107.

The heparin syringe is not a prescribed item and should be individually selected on the “Heparin” screen when loading the heparin syringe during treatment setup.



Warning! The correct syringe type must be selected to ensure an accurate infusion.

After entering the heparin prescription, select the **Done** button to return to the main “Prescription” screen. There the **BP Settings** button may be selected to enter the blood pressure-related parameters. Turn to the next page to enter the blood pressure prescription.

Entering BP Settings on the “Prescription” screen:

Each of the editable blood pressure parameters are displayed to the right of the **BP Settings** screen-button. To edit the blood pressure parameters, select the **BP Settings** screen-button. The “BP Settings” screen will be displayed (see Figure 66 below).

Blood Pressure Alarm Limits	
Upper Sys	Lower Sys
180 mmHg	60 mmHg
Upper Dia	Lower Dia
120 mmHg	30 mmHg
Upper Pulse	Lower Pulse
150 /min	40 /min

Blood Pressure Settings	
Inflation Pressure	Interval
Auto mmHg	0:15 h:min

Figure 66 – The Prescription Screen BP Settings Subscreen

The “BP Settings” subscreen shows the blood pressure-related parameters set on the “Blood Pressure” screens. For a description of these buttons, see page 116.



Note: The name of the parameter button displayed to the right of the **Inflation Pressure** button depends on the ‘Auto BP Reading’ Service Mode option, see page 118 for more information.

After entering the blood pressure prescription, select the **Done** button to return to the main “Prescription” screen. There the **UF Settings** button may be selected to enter the UF-related parameters. Turn to the next page to enter the ultrafiltration prescription.

Entering UF Settings on the “Prescription” screen:

Each of the editable dialysate parameters are displayed to the right of the **UF Settings** screen-button. To edit the ultrafiltration (UF) parameters, select the **UF Settings** screen-button. The “UF Settings” screen will be displayed (see Figure 67 below).

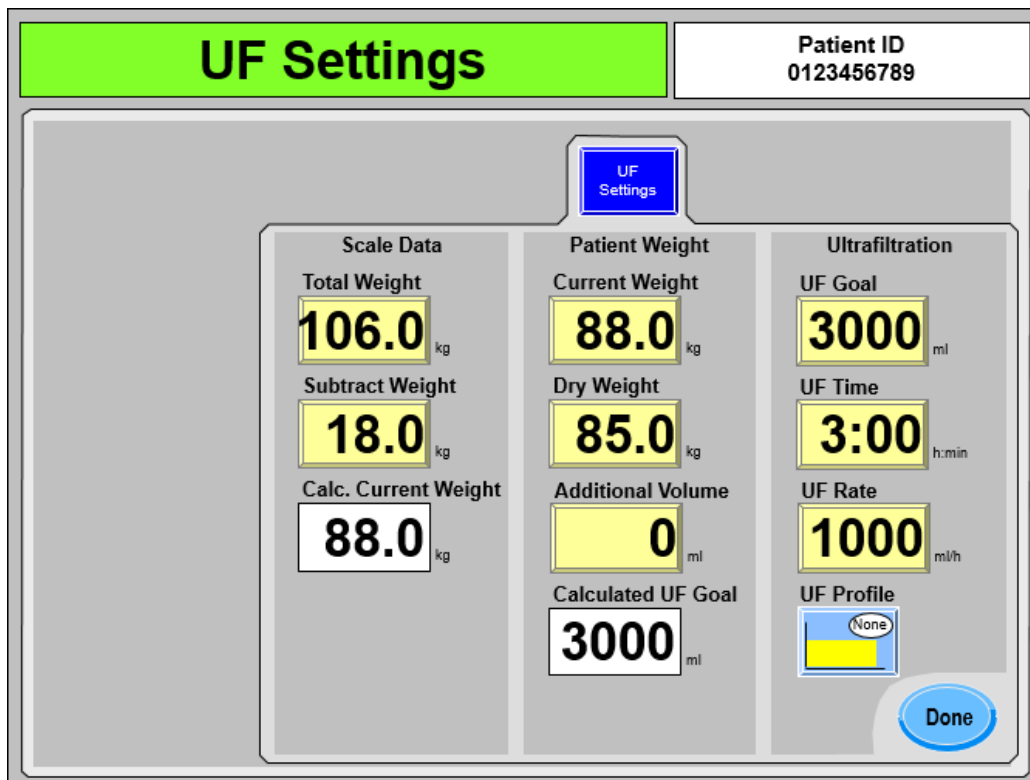
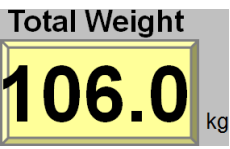









Figure 67 – The Prescription Screen UF Settings Subscreen

The “UF Settings” subscreen groups UF-related parameters set on the “Home” screen with parameters accessible only in these “Prescription” screens.

- For a description of the **UF Goal**, **UF Time**, and **UF Rate** buttons, see page 93.
- For a description of the **UF Profile** button, see page 98.

Table 24 – Features Unique to the UF Settings Screen

Feature	Function
<p>Total Weight</p> 	<p>Total Weight—This is the total weight in kilograms when the patient was weighed with a scale before the treatment. This value may include the patient’s clothing, wheelchair, gurney, or other equipment.</p>
	<p> Note: If the patient scale is equipped with a PatientCard Reader, the total weight can be automatically transferred to be displayed here. Contact Fresenius Medical Care Spare Parts department or your sales representative for more information and pricing.</p>

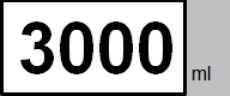
Feature	Function
<p>Subtract Weight</p> 	<p>Subtract Weight—This is the weight in kilograms of the patient’s clothing, wheelchair, gurney, or other equipment that will be subtracted from the total weight. The calculated value is then displayed in the Calc. Current Weight meter-box below.</p>
<p>Calc. Current Weight</p> 	<p>Calc. Current Weight—This meter box displays the current weight calculated by subtracting the Subtract Weight value from the Total Weight value. This calculated value will carry over to the yellow Current Weight parameter-button at the top of the middle column. Editing the yellow Current Weight parameter-button will not change the calculated UF goal in this meter box.</p>
<p>Current Weight</p> 	<p>Current Weight—This is the weight in kilograms when the patient was weighed with a scale before the treatment. This value can be adjusted independently from the calculated current weight (see above).</p>
<p>Dry Weight</p> 	<p>Dry Weight—This is the prescribed, ideal weight (in kilograms) for the patient after ultrafiltration has been performed.</p> <p> Note: If the Dry Weight is less than 40 kg, the ‘Low Volume’ option on the “Test & Options” screen will automatically be set to ‘Yes’. For more information about Low Volume dialysis, see page 115.</p>
<p>Additional Volume</p> 	<p>Additional Volume—This is the amount of fluid (in milliliters) that is added to difference between the current weight and dry weight to calculate the UF goal. This value could include the saline rinse back volume or the volume the patient may drink during treatment.</p>
<p>Calculated UF Goal</p> 	<p>Calculated UF Goal—This meter box displays the ultrafiltration goal (in milliliters) calculated by subtracting the dry weight from the current weight and adding the additional volume. This value will carry over to the yellow UF Goal parameter-button at the top of the middle column (and on the “Home” screen). Editing the yellow UF Goal parameter-button will not change the calculated UF goal in this meter box.</p>

After entering the ultrafiltration prescription, select the **Done** button to return to the main “Prescription” screen. There the remaining parameter-buttons may be selected. Turn to the next page to finish entering the prescription.

Setting the Remaining Parameters on the Prescription Screen:

The remaining parameters to be set on the “Prescription” screen are located in the lower right corner.

Prescription		Patient ID 0123456789	
Dialysate Settings	Concentrate 08-2251-CA 45X Base Na ⁺ 138 mEq/l Bicarbonate 32 mEq/l Temperature 37 °C Dialysate Flow 800 ml/min SVS Profile Lin Start Na ⁺ 140 mEq/l SVS-Time 3:00 h:min	UF Settings	Total Weight 106.0 kg Subtract Weight 18.0 kg Current Weight 88.0 kg Dry Weight 85.0 kg Additional Vol. 0 ml UF Goal 3000 ml UF Time 3:00 h:min UF Rate 1000 ml/h UF Profile None
Heparin Settings	Heparin Rate 1.0 ml/hr Infusion Time 2:30 h:min Bolus 1.0 ml	Blood Pump Rate <div style="border: 1px solid black; padding: 2px; display: inline-block;">300</div> ml/min	BV Alert Level <div style="border: 1px solid black; padding: 2px; display: inline-block;">-15</div> %
BP Settings	Upper Sys 180 mmHg Lower Sys 60 mmHg Upper Dia 120 mmHg Lower Dia 30 mmHg Upper Pulse 150 /min Lower Pulse 40 /min Inflation Pres Auto mmHg Interval 0:15 h:min	OLC Volume <div style="border: 1px solid black; padding: 2px; display: inline-block;">30.0</div> L	O ₂ Alert Level <div style="border: 1px solid black; padding: 2px; display: inline-block;">89</div> %
		Target Kt/V <div style="border: 1px solid black; padding: 2px; display: inline-block;">0.0</div> <small>Single Pool</small>	<div style="border: 1px solid black; border-radius: 50%; padding: 5px; display: inline-block;">Done</div>

Figure 68 – Setting the remaining parameters on the Prescription Screen

- For a description of the **Blood Pump Rate** button, see page 96.
- For a description of the **OLC Volume** and **Target Kt/V** buttons, see page 147.
- If applicable, see Table 32 on page 159 for descriptions of the Crit-Line **BV Alert Level** and **O₂ Alert Level** button or page 156 for the BVM (**BV**) **Alert Level** button.

Saving and transferring the “Prescription” screen settings:

After entering the remaining prescription items, select the **Done** button to exit the main “Prescription” screen.

If no changes to the prescription have been made, the “Prescription” screen settings will be automatically transferred to the various Dialysis program screens used during treatment.

If any changes were made by the operator, the 2008T hemodialysis machine will display a pop-up window with a list of all changes that were made. If the **Escape** key is pressed, the changes will not be saved and no settings will be transferred to the Dialysis program screens. If the **CONFIRM** key is pressed, this modified prescription will then be automatically transferred to the various Dialysis program screens used during treatment and display another pop-up asking the operator if this modified prescription should be saved to the PatientCard.



Note: Keep the PatientCard in the PatientCard Reader slot during the treatment in order to save the treatment history at the end of the treatment. Any changes made to the parameters on the various dialysis screens after pressing the **Done** button on the “Prescription” screen will not be saved to the PatientCard.

Treatment options like Single Needle and High Flux dialyzers may be set on the “Test & Options,” see page 112 for more information. At this point, all treatment parameters should have been entered and it is time to connect the patient and begin the treatment; turn to the next page to continue.

Starting Dialysis

At this point, all treatment parameters and options should have been entered. If a reuse dialyzer is used, the dialysate should already be verified for absence of disinfectant. Verification of prescription, conductivity, and pH should also have been confirmed. It is now time to connect the patient to the 2008T hemodialysis machine via the blood tubing and begin the dialysis treatment.



Note: Follow established unit protocol regarding procedures for establishing aseptic blood connections.

1. Before starting dialysis, complete the patient assessment per unit policy.
2. Apply the blood pressure cuff around the patient's non-access arm so the middle of the cuff is at the level of the right atrium of the heart and the center of inflation bag is over the brachial artery. Be sure the Index Line falls between the two Range Lines. If it does not, a larger or smaller cuff is required.



Warning! Be sure the cuff is the correct size and placed at heart level. An improperly fitted cuff may cause inaccurate blood pressure readings due to under or over compression of the brachial artery. Each centimeter above or below heart level will cause an error of ± 0.8 mmHg. Use the following precautions:

- Applying the cuff over a wound can cause further injury;
- Applying the cuff to a limb where intravascular access or therapy, or an arterio-venous (A-V) shunt, is present could result in patient injury due to temporary interference to blood flow;
- Applying the cuff on the arm on the side of a mastectomy could result in patient injury.

Warning! To avoid potential patient injury caused by blood flow interference due to continuous cuff pressure, do not allow compression or kinking of the hose tubing connecting to the blood pressure cuff.



Note: For best blood pressure measurement results, comfortably seat the patient with back and cuff arm supported, legs uncrossed, and feet flat on the floor. Instruct the patient to relax as much as possible and not talk during blood pressure readings. Allow at least 5 minutes to elapse from the time the patient sits down before taking the first reading.

Blood pressure readings can be affected by the measurement site, the position of the patient, exercise, and the patient's physiologic condition. Performance of the blood pressure monitoring subsystem can be affected by extremes of temperature, humidity and altitude.

3. If the CLiC device will be used for this treatment, clip the CLiC device on the Crit-Line Blood Chamber at this time. For more information, see the *2008T Hemodialysis Machine with CLiC User's Guide* (P/N 490206).

4. Verify that ultrafiltration is off (UF light is off), and that the **UF Removed** button is reset to zero. The UF removed may be reset by selecting **UF Removed** button and then the 0 key and confirming the change.
5. Verify that the venous line is in the venous clamp and the optical detector. Verify that the optical detector door is closed.



Warning! Do not infuse the recirculated saline prime into the patient. Discard the recirculated saline and fill the extracorporeal circuit with fresh saline prior to connecting to the patient. The volume of fresh saline used to fill the extracorporeal circuit should be equal to the volume of the dialyzer and blood tubing set in use.

6. Lower the blood pump rate to 150 ml/min and then press the blood pump **Start/Stop** key to stop the pump.
7. Connect the patient and initiate treatment according to unit protocol.



Warning! Check all bloodline and dialysate line connections for fluid leaks. Keep access sites uncovered and monitored. Improper bloodline connections or needle dislodgements can result in excessive blood loss, serious injury, and death. Machine alarms may not occur in every blood loss situation.

8. Start the blood pump and adjust the blood flow rate to establish dialysis and the alarm limits. Establish the prescribed blood flow rate.
9. Rotate the dialyzer to arterial inlet up if desired.
10. Select the **Tx Clock** button and press **CONFIRM** to start the treatment.
11. Check that UF/SVS/Heparin are on, if prescribed. If applicable, a blood pressure measurement is initiated.



Warning! When establishing blood flow, ensure that air will not be infused into the patient.

Warning! Check all bloodlines for kinking. Improper blood flow may cause hemolysis of the blood.

Continue to the next page to monitor the treatment.

Monitoring the Treatment

Several of the treatment screens available on the 2008T hemodialysis machine are particularly useful for monitoring some aspects of the patient's condition and the effectiveness of the treatment. These screens are the:

- Home screen
- Trends screen
- Kt/V AF screen
- Crit-Line or BTM/BVM screen
- Blood Pressure screen

The "Home" screen provides a general overview of the status of the current treatment. The other screens offer a more in-depth view of specific aspects of the treatment. It should be noted, however, that certain treatment data are presented in more than one screen.



Warning! When initiating dialysis therapy with the dialysis machine, it is important to check your dialysate flow status. Flows must be set to the prescribed flow Rate. Setting the Dialysate Flow to zero for Sequential Ultrafiltration must be used only when prescribed. Treatment without dialysate flow may result in patient injury due to minimal removal of waste products in the patient's blood.

Warning! Turning the dialysate flow off when using a reused dialyzer may allow the chemical disinfectant to rebound (increase) to an unacceptable level.

Warning! Keep bloodline/catheter or needle connection visible. Do not cover the access site, e.g. with a blanket.



Caution: If it becomes necessary to replace the concentrate jugs or to switch from a *bi*bag disposable to liquid bicarbonate during treatment, first do the following: Make sure the optional *bi*bag door is closed with no *bi*bag disposable on it and turn the dialysate flow off. This must be done to avoid drawing air into the system. Drawing air into the system can cause the concentrate pumps to malfunction.



Note: The 2008T hemodialysis machine is equipped with both visual cues and audible alarms to alert the operator to potential problems. In every alarm condition, assess the patient for any changes in his/her physiologic state. Ensure that the patient's access is exposed and all connections in the extracorporeal circuit are secure and visible during the entire procedure. It is the responsibility of the dialysis personnel to provide safe and effective dialysis treatment. Document all atypical events.

Note: The **SVS Profile** and **Heparin** buttons are colored green when their systems are running (functional software version 2.34 or later).

Note: If a "bi*bag*: Cond Low" alarm occurs when there is only about one inch (2.5cm) of bicarbonate left at the bottom of the *bi*bag disposable, the bag is at the end of its useful life. Replace the bag with a fresh bag (see page 166 for instructions).

Home Screen Monitoring

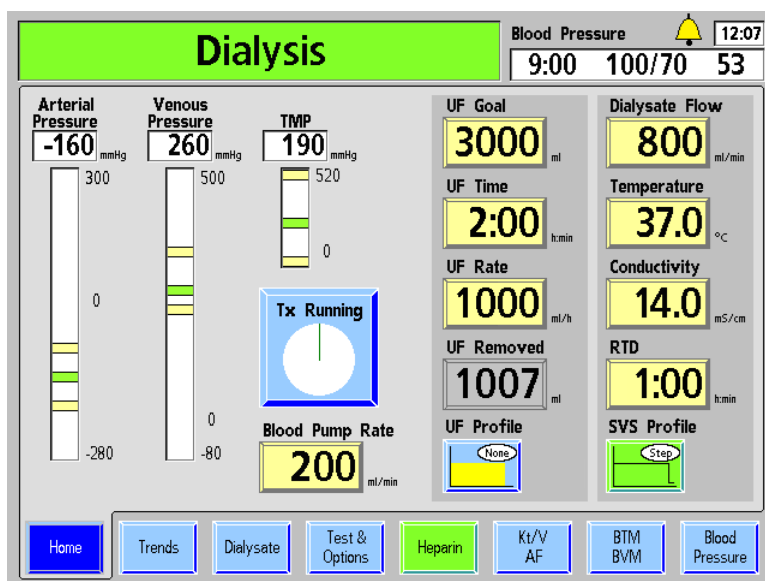

Figure 69 – Treatment Monitoring using the Home Screen (showing functional software version 2.72 or later)







The “Home” screen provides an up-to-the-minute view of the status and progress of the treatment. The flow rate, temperature, and conductivity of the dialysate, the status of the ultrafiltration process, and the amount of treatment time left can all be found here. The following table describes the data provided by the buttons found in the “Home” screen.

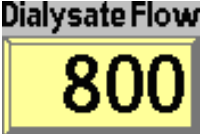

Note: If the 2008T hemodialysis machine is set up in Service Mode to display the “Crit-Line” screen instead of the “BTM BVM” screen, the various functions and parameters of the treatment can also be viewed on the “Crit-Line” screen. For more information, see the “Crit-Line Screen” on page 157.

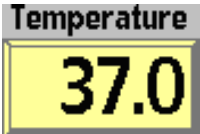
Table 25 – The Home Screen Buttons

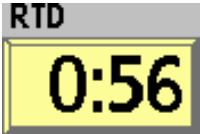
Button	Data
	Displays the desired UF to be removed during the treatment. This is typically the difference between the patient’s pre and dry weight plus saline or fluid intake during treatment.
	The UF Time button acts as a countdown timer displaying the remaining time ultrafiltration will be performed. The timer stops when the UF pump is stopped. Blood alarms or online pressure holding tests also temporarily stop this timer.
	During treatment, this button displays the current rate of ultrafiltration in milliliters per hour (ml/hr). The rate ultrafiltration occurs is determined by the values entered in UF Goal and UF Time, and the UF Profile selected. The UF Rate will automatically drop to 70 ml/hr when the UF Goal is achieved (or 300 ml/hr if the high flux option in the “Test & Options” screen is selected), or when blood flow is ≤ 90 ml/min. The rate flashes when the UF pump is off and there is no ultrafiltration.

Button	Data
	<p>This button keeps a running total of the fluid drawn from the patient through ultrafiltration. When the value displayed in UF Removed is equal to the value entered in UF Goal, a Low Alarm sounds and the message, “UF Goal Reached” is displayed in the Status Box. Pressing and confirming the New Tx key resets this value to zero. The UF Removed button can be selected only when the Tx Clock is paused.</p>
	<p>This button displays the current dialysate flow rate. If 1.5x or 2x is selected, the flow rate will be indicated as follows: a800.</p> <p>To turn off dialysate flow using the Dialysate Flow button, select it and either use the ↓ key to scroll down to OFF or press the 0 key and then press the CONFIRM key. To turn dialysate flow back on, select the Dialysate Flow button, set it to the desired value, and press the CONFIRM key.</p> <p> Note: The value displayed in the Dialysate Flow button will flash when dialysate flow is set to ‘OFF’ from the “Dialysate” screen (see page 83 for more information). The Dialysate Flow on/off button on the “Dialysate” screen can also be used to turn the dialysate flow back on when desired.</p>
	<p>The current temperature of the dialysate. Selecting this button allows the desired temperature to be set. If the temperature varies or ± 2 °C from set point, this button turns red, an alarm sounds with a message in the Status Box, and the dialysate goes into bypass.</p>
	<p>This button displays the current conductivity of the dialysate. Selecting this button during treatment will open the “Dialysate” screen. If the conductivity varies outside of the alarm limits, this turns the button red, an alarm sounds, a message is displayed in the Status Box, and the dialysate goes into bypass.</p>
	<p>RTD (Remaining Time of Dialysis) This button acts as a countdown timer displaying the amount of treatment time remaining. At the end of treatment when RTD is 0:00, an alarm sounds and the message, “RTD = ZERO” is displayed. Any alarm situation will stop the RTD countdown.</p>
	<p>The Tx Clock button is selected and confirmed to start or pause the treatment. The green segment of the pie chart represents the amount of treatment completed. The green segment grows as the treatment progresses. The circle will be completely green when RTD is equal to zero. During treatment, this button displays the message, “Tx Running.” Selecting and confirming this button will interrupt the treatment and the button will display the title, “Tx Paused.” When the treatment is paused, the green segment will change to yellow, the UF and heparin pumps stop and SVS program pauses, and the RTD, UF, and heparin infusion Time buttons stop counting down. The sodium content of the dialysate remains at the profile level it was when the treatment was paused. The blood pump and the dialysate flow, however, remain running.</p>

Button	Data
	This button displays the speed of the blood pump and allows the operator to set it from the display screen in addition to the module. The rate, displayed in ml/min, can be entered from 0 to 600 in increments of 5. Setting the blood flow rate to zero will stop the blood pump. The blood flow rate flashes when the blood pump is stopped.

Bar graphs on the Home Screen

The three bar graphs on the “Home” screen represent the various pressures associated with dialysis treatment. The first two bar graphs represent the pressures inside the arterial and venous drip chambers. The third bar graph, Transmembrane Pressure (TMP), represents the opposing blood and dialysate pressures being exerted from opposite sides on the dialyzer membrane.



Warning! The pressure changes resulting from a line separation or needle removal may be too small for the system to detect. All connections must be properly secured and checked regularly. Access sites and connections should remain uncovered for monitoring.

Arterial Pressure

The arterial pressure is the measure of the pressure inside the arterial drip chamber. The arterial pressure is read by a transducer inside the Blood Pump module. The drip chamber and transducer are connected by way of a pressure line that runs from the arterial drip chamber to the blood pump’s arterial pressure port (P_{Art.}). A transducer protector is fastened over the pressure port to guard against contamination of the transducer in case of a fluid surge within the chamber.

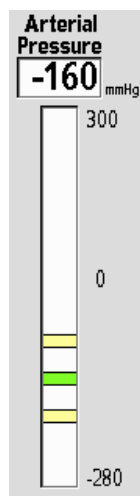

Arterial pressure is digitally displayed in mmHg on the left side of the “Home” screen above a corresponding vertical bar graph. In the bar graph, under normal conditions, arterial pressure is represented by a green horizontal bar between two yellow bars that represent the upper and lower alarm limits. The area between the limits is the alarm window. The alarm limits are automatically set. When the arterial drip chamber is positioned before the blood pump in the extracorporeal blood circuit, the arterial pressure reading should be a negative value.

Unusually high or low pressures may be the result of kinks in the blood tubing, clotting, or a needle pressing against the vessel wall. Problems such as these may cause pressure readings to rise or fall outside the alarm window. When this happens, the arterial pressure bar changes from green to red, an alarm sounds, the blood pump stops, and venous line clamp closes. A Low Alarm message appears in the Status Box.

Alarms are not immediate and a variable time delay mechanism, dependent on the magnitude the pressure deviates outside the alarm window, allows for momentary minor changes in pressure. Adjusting the blood pump rate will cause the alarm limits to spread, allowing the pressure to stabilize before new limits are re-established.

Venous Pressure

The venous pressure is the measure of pressure inside the venous drip chamber. The venous pressure is measured by a pressure transducer located inside the Level Detector module. The drip chamber and transducer are connected via a pressure line that runs from the chamber to venous pressure port ($P_{Ven.}$) located on the front of the module.

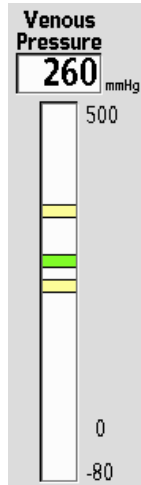

The venous pressure is represented in the same way as the arterial pressure, with the pressure digitally displayed in mmHg above a corresponding bar graph. In the bar graph, under normal conditions, the pressure is represented by a green horizontal bar between yellow bars representing the upper and lower alarm limits. During alarm conditions, when the pressure rises or falls outside the alarm window, the venous pressure bar changes from green to red. When alarm sounds and the blood pump stops, venous line clamp closes, and a message appears in the Status Box.

The alarm limits are set with a time delay for stabilization. Adjusting the blood pump rate will cause the alarm limits to spread and stabilize before new limits are established.

For 100 asymmetric limits, one minute after the alarm limits are centered the lower limit will close to within 20 mmHg to 35 mmHg of the actual venous pressure and the pressure limits will be activated. If in the course of the treatment, as the venous pressure increases, a clue to increasing viscosity from ultrafiltration, the alarm limits will be automatically re-centered and then closed after one minute every 30 minutes during the treatment. This is intended to keep the lower venous limit as tight as practical.

Increasing the blood pump rate will cause the alarm limits to spread in the appropriate direction temporarily, i.e., a higher blood pump rate will increase the venous pressure.



Warning! The low venous pressure alarm may not occur with every disconnection or needle dislodgement. Check all bloodlines for leaks after the treatment has started. Keep access sites uncovered and monitored. Improper bloodline connections or needle dislodgements can result in excessive blood loss, serious injury, and death. Machine alarms may not occur in every blood loss situation.



Note: When the optical detector senses blood, the minimum the lower venous pressure limit will be set to is + 9 mmHg.

Transmembrane Pressure (TMP)

The transmembrane pressure (TMP) is equal to the dialysate pressure minus the venous pressure measured in mmHg. On the 2008T hemodialysis machine, the TMP is normally negative. Because the machine uses a closed, volumetric ultrafiltration system, the TMP is monitored primarily for detecting large shifts in pressure. In certain situations involving high-flux dialyzers, high blood-flow rate, or low UF rate, the TMP may approach 0 mmHg.

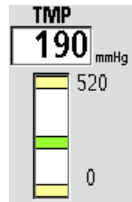

After a time delay for stabilization, the alarm limits are automatically set at ± 60 mmHg for conventional dialyzers, and ± 40 mmHg for high flux dialyzers. The alarm window automatically adapts for gradual increases in TMP caused by increasing blood viscosity resulting from ultrafiltration.



Warning! After starting dialysis, determine whether a stable TMP has been obtained and whether it corresponds to the ultrafiltration coefficient (KUF) of the dialyzer. TMP must be closely monitored with the alarm limits. The TMP may not change substantially during UF errors when high permeable dialyzers are in use. A fluctuating TMP, except in cases of single-needle dialysis, may indicate a malfunction in the balancing system. A high TMP may indicate a leak in the dialysate side of the system. Frequent Fill programs may indicate air in the balancing system. Some, but not all, UF errors can be checked by measuring the volumetric accuracy of the UF pump via the Fluid Sample Port using a graduated cylinder. If the cause cannot be corrected quickly, discontinue treatment.



Note: The approximate expected TMP can be calculated from the dialyzer blood ultrafiltration coefficient (KUF) and the UF rate:

$$\text{TMP} = (\text{UF Rate})/(\text{KUF})$$



Warning! When using highly permeable dialyzers, the dialysate side is frequently above atmospheric pressure (because of the venous pressure and low TMP). Although uncommon, any dialysate fluid leak from the dialysate side of the system will add to the intended ultrafiltration rate. Observe the system for fluid leaks and discontinue treatment if you are unable to correct any fluid leak quickly.

Trends Screen Monitoring

The “Trends” screen provides treatment status information similar to that found in the “Home” screen. The left side displays three graphs depicting the treatment progress of Clearance, SVS and UF profiles, and blood pressure history during the current patient’s treatment. The right side of the screen displays treatment summary data (see Figure 70).

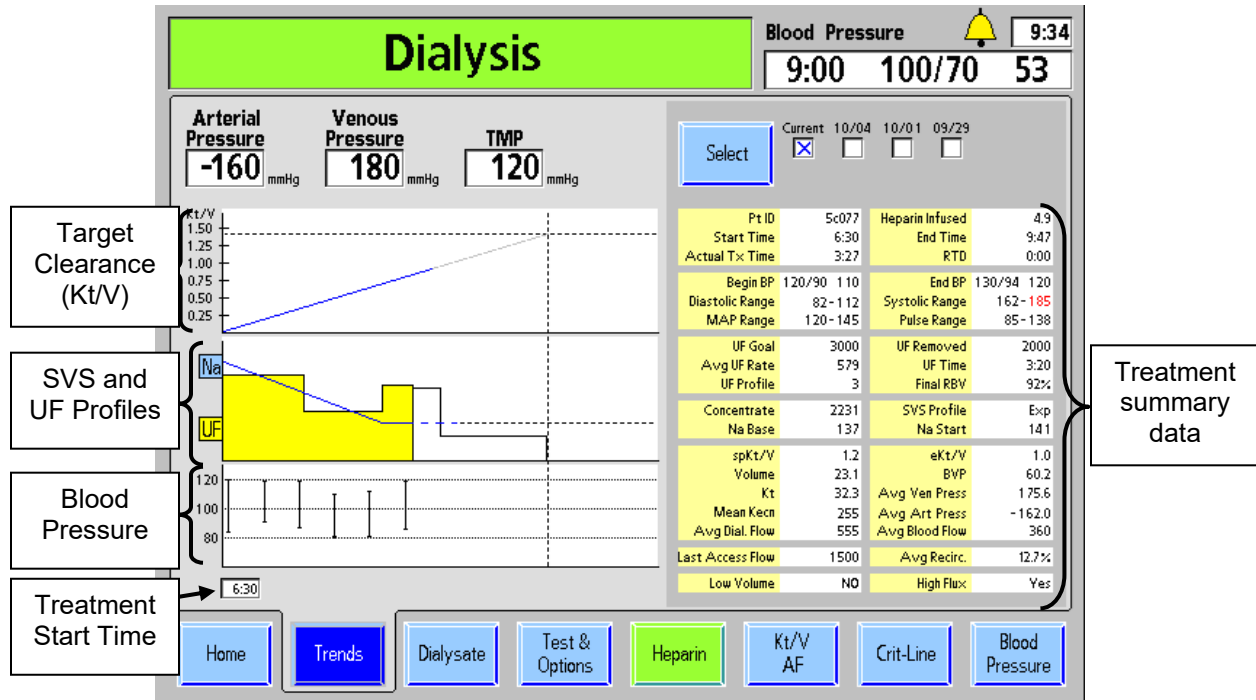

Figure 70 – The Trends Screen (with PatientCard Inserted)

These graphs provide information similar to those found in the Kt/V, Blood Pressure screens, SVS, and UF subscreens. Consolidating them here, along with the treatment summary information gives an overview of the entire treatment. If necessary, the treatment summary results from the prior treatment may be recalled.

Table 26 – The Trends Screen Buttons

Button	Function
	This button is used to display either the current or previous treatment summary data.
	When a PatientCard is inserted, this button allows the operator to view the past three stored treatment dates.

The following is information about each of the items in the treatment summary display.

Table 27 – The Treatment Summary Information

Display	Description
Pt ID	This is the patient ID.
Start Time	This is the clock time when the Tx Clock button is selected (24 hour clock).
Actual Tx time	This is the total treatment time, even if the treatment continued after RTD counted down to zero (minutes).
Hep. Infused	This is the amount of heparin infused to the patient at this point in time (ml).
End Time	If the treatment is still underway, this is the projected time for the end of treatment, based on the current time and RTD. Otherwise it is the clock time when the treatment actually ended, based on the Tx clock (24 hour clock).
RTD	The current Remaining Time of Dialysis (minutes).
Begin BP	Displays the first Diastolic, Systolic (mmHg) and pulse reading (beats/min). If any of the readings is out of the alarm range, the entire line is shown in red.
Diastolic Range	Displays the highest and lowest Diastolic pressure reading during the treatment. If any of the readings is out of the alarm range, the entire line is shown in red.
MAP Range	Displays the highest and lowest Mean Arterial Pressure (MAP) during the treatment. If any of the readings is out of the alarm range, the entire line is shown in red (mmHg).
End BP	Displays the last Diastolic, Systolic and pulse reading. If any of the readings is out of the alarm range, the entire line is shown in red.
Systolic Range	Displays the highest and lowest Systolic pressure reading during the treatment. If any of the readings is out of the alarm range, the entire line is shown in red.
Pulse Range	Displays the highest and lowest pulse rate during the treatment. If any of the readings is out of the alarm range, the entire line is shown in red.
UF Goal	This is the UF goal selected for the treatment (ml).
Avg UF Rate	This is the average UF rate at this point in the treatment (ml).
UF Profile	This is the number of the UF profile selected for the treatment.
UF Removed	This is the UF removed at this point in the treatment (ml).
UF Time	This is the UF time selected for the treatment (min).
Final RBV	This is the last Relative Blood Volume from the BVM, if available (% of initial value).
Concentrate	This is the concentrate selected for this treatment.
Na Base	This is the base Na ⁺ level for the Sodium Variation System program (mEq/l)

Display	Description
SVS profile	This is the Sodium Variation System profile selected for the treatment.
Na Start	This is the starting Na ⁺ level for the Sodium Variation System program (mEq/l). If SVS is not selected, it is the sodium used.
SpKt/V	This is the current Single pool Kt/V (SpKt/V). If the projected Kt/V is below the acceptable level, the value is shown in red.
Volume	This is the volume used for the Kt/V calculation (liters).
Kt	This is effective blood volume processed (liters).
Mean Kecn	The time weighted average of the individual Kecn measurements.
Avg Dial. Flow	This is the average dialysate flow used for the treatment (ml/min).
eKt/V	This is the current equilibrated Kt/V (eKt/V).
BVP	This is total blood volume processed (liters).
Avg Art Press	This is the average arterial pressure for the treatment (mmHg).
Avg Ven Press	This is the average venous pressure for the treatment (mmHg).
Avg Blood Flow	This is the average blood flow used for the treatment (ml/min).
Last Access Flow	This is the last access flow determination, if available (ml/min).
Avg Recirc.	This is the average of all the recirculation determinations made for this treatment (%).
Low Volume	This shows whether or not the Low Volume option is set.
High Flux	This shows whether or not the High Flux dialyzer option is set.



Warning! Do not use the values displayed on the machine solely in making future therapy decisions. If any value far exceeds the expected range, confirm the measurement through independent means before making any changes to the patient's prescription.

Kt/V & Access Flow Monitoring

How Kt/V is Derived

Online Clearance (OLC)—used in estimating the effectiveness of the dialysis treatment—can be viewed in the “Kt/V AF” screen. The effectiveness of the treatment is based on the amount of urea that is removed from the patient’s blood. It has been shown that sodium can be used as a surrogate to urea for determining removal rates (clearance). The key to determining the amount of urea cleared is based on the fact that urea clearance is almost identical to sodium clearance.

To measure the effectiveness of treatment, the concentration of sodium in the dialysate is adjusted for a brief duration. This changes the conductivity of the dialysate. The conductivity of the dialysate is then measured before and after it passes through the dialyzer. As the dialysate passes through the dialyzer, some of the sodium diffuses through the membrane resulting in a different, post-dialyzer, conductivity reading. The amount of sodium clearance (Kecn) can be calculated based on the change in conductivity of the dialysate after it passed through the dialyzer.

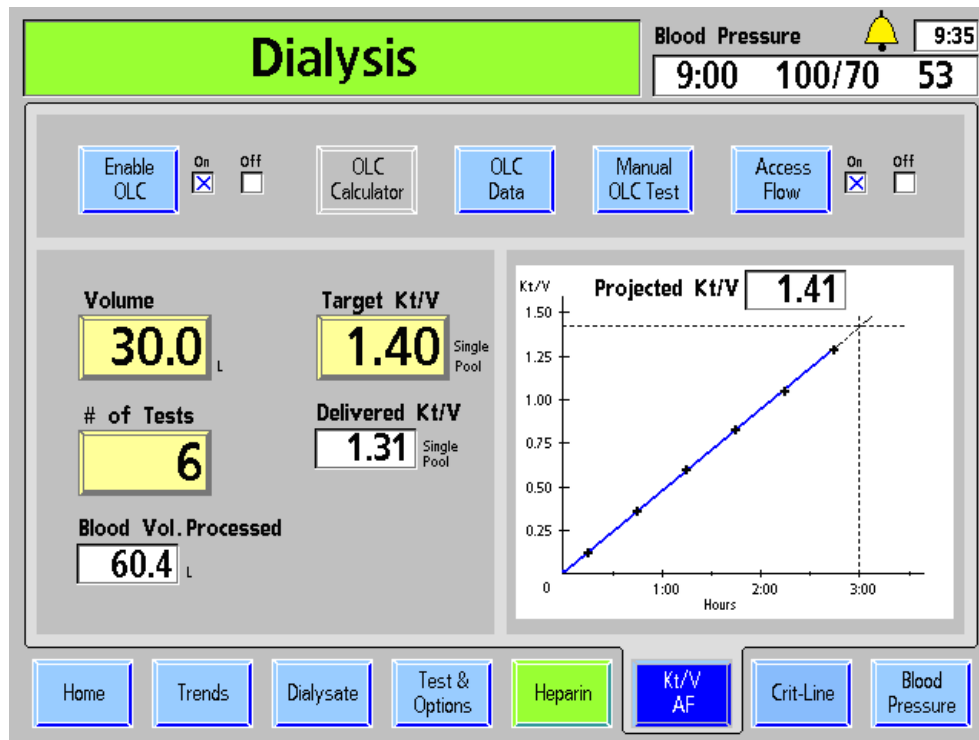



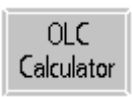

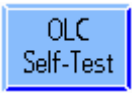
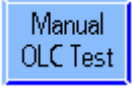
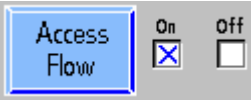

Figure 71 – The Kt/V and Access Flow Screen

The following table describes the features found in the “Kt/V AF” screen on machines with active OLC functionality.



Note: If the OLC functionality has been deactivated (in the Service Mode) on your machine, all features will be inactive and appear grayed out.

Table 28 – The “Kt/V AF” Screen Buttons and displays

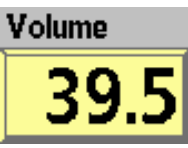
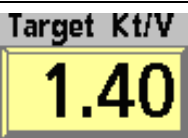
Button	Function
	This button activates and deactivates the OLC option as indicated by the check box to the right. By default, OLC is enabled.
	This button brings up the OLC Calculator—a useful tool for estimating the treatment effectiveness and time required based on various treatment parameters. (Not available at this time).
	Selecting the OLC Data button opens the “OLC” subscreen that provides the actual results of each OLC test.
 	<p>This button changes functions based on the machine status.</p> <p>When there is no blood sensed and the blood pump is stopped or the dialysate lines are on the shunt, selecting this button followed by the CONFIRM key initiates the OLC Self Test.</p> <p>When blood is sensed, an unscheduled clearance test is initiated. The manual test takes the place of one of the scheduled tests entered in the # of Tests button.</p>
	<p>This button is used to allow the Access Flow test to be performed. When it is turned On, the machine will offer to do the Access Flow test following the next OLC test. If it is inconvenient to do the test early in the treatment, this button may be left in the Off position and turned On when it is convenient. Select the Manual OLC Test button and press CONFIRM after turning on the Access Flow to begin the process right away. When the test is initiated, the operator is guided through the steps necessary to perform the test.</p>
	 <p>Warning! To avoid the possibility of significant blood loss, be sure that the connections are well secured after disconnecting and reconnecting the bloodlines.</p>
	The patient’s urea-distribution volume (in liters) is entered here. This value should be determined using urea-kinetic values. Anthropometric formulae may give different results than kinetically calculated urea-distribution volume. This button is displayed as OLC Volume on the “Prescription/Default Parameters” screen.
	The prescribed target single-pool value, ranging from 0.40 to 2.50, is entered in this button. This value is reset to the default value when the New Tx key is pressed. The default value may be changed in Service Mode.

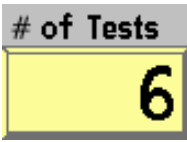
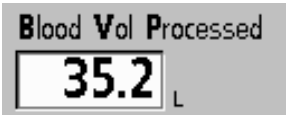
Button	Function
	The # of Tests button is used to access the number of tests that will be run automatically during dialysis. From one to six tests can be chosen per treatment (six is the default setting). The first and last tests are conducted 15 minutes after the beginning of dialysis and 15 minutes before the end of dialysis. The remaining tests are performed at equally spaced intervals between the first and last tests, unless manual tests are run.
	This value indicates the total blood volume (in liters) that has passed through the dialyzer based on the blood pump flow rate.
Projected Kt/V	This is the expected Kt/V when RTD is at zero, based on the delivered Kt/V and the Kecn values.
Delivered Kt/V	This is the delivered Kt/V at this point in the treatment.

Reading Kt/V

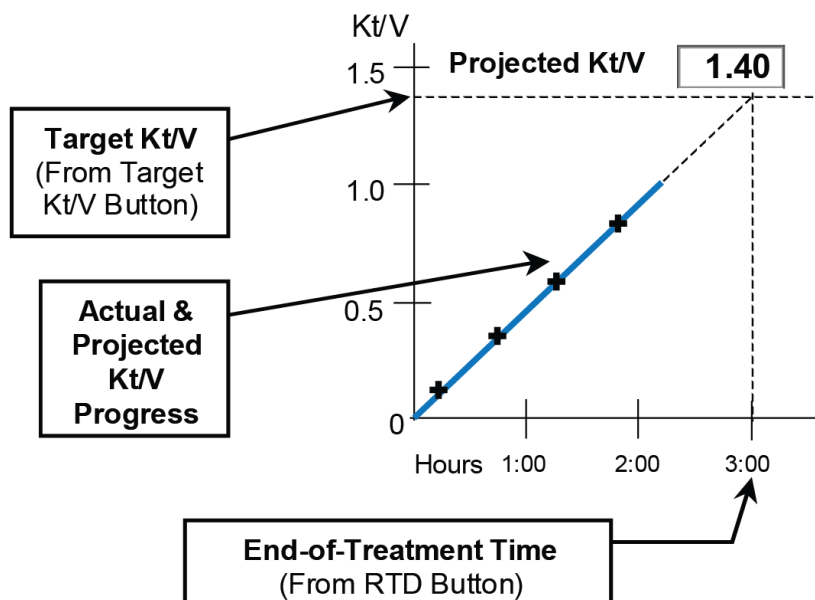

Figure 72 – Kt/V Graph

The Kt/V graph is located on the right side of the “Kt/V AF” screen (See Figure 71). The vertical axis on the left side of the graph represents target Kt/V values. The horizontal axis along the bottom of the graph represents treatment time in hours.

The horizontal, dashed line near the top of the graph represents the value displayed in the **Target Kt/V** button. The vertical, dashed line located on the right side of the graph represents the prescribed length of the treatment (i.e., the value displayed in the **RTD** button of the “Home” screen at the start of treatment). The point where these lines cross represents the target Kt/V at the end of the prescribed treatment.

After the first OLC test, a line appears in the Kt/V graph that plots both the current and anticipated effectiveness of the treatment. The solid blue or red line represents the current amount of delivered therapy (Kt/V) from the beginning of treatment up to the time of the last test. The gray dotted portion indicates the projected effectiveness of the treatment assuming the clearance rate remains steady at its present rate. If the effectiveness of the treatment is projected to reach at least 100% of the minimum Kt/V or 85% (depending on selected Service Mode option) of the target Kt/V at the end of treatment, the solid portion of the curve will appear blue. If the projected effectiveness is less than 100% of the target Kt/V, the solid portion of the plot appears red and an exclamation mark icon is displayed to the right of the graph.

Using Figure 71 as an example, the graph indicates the following data:

- The last test was taken about two hours and 45 minutes after the beginning of a three-hour treatment.
- The target Kt/V is 1.40
- The Kt/V at the current time (Delivered Kt/V) is 1.31
- The projected Kt/V at the end of the treatment is 1.41
- Since the Projected Kt/V of the treatment is 100 percent of the target Kt/V (1.40) by the end of treatment, the line is blue.

If after an OLC test, the projected effectiveness for the end of the treatment is less than 100 percent of the target Kt/V, the solid portion of the plot appears red and an exclamation mark icon is displayed to the right of the graph (see Figure 73 below).

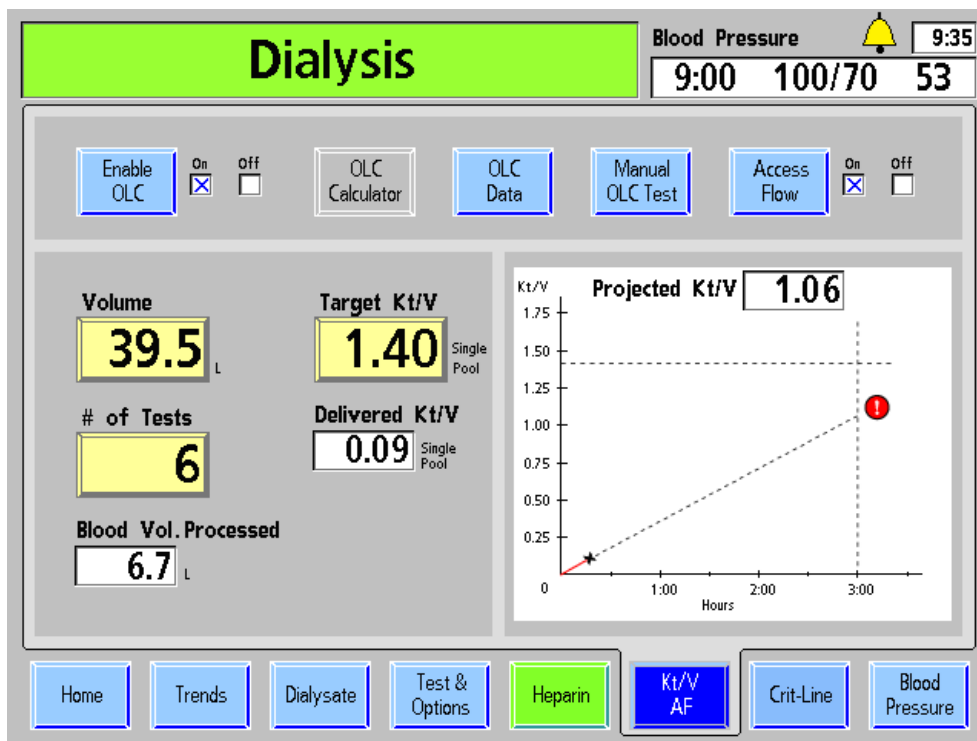

Figure 73 – Projected Clearance is less than 100 Percent of Target

In cases of unsatisfactory Kt/V, the operator should check:

- For proper needle placement and connections to the bloodlines.
- That the machine is set for prescribed blood flow rate.
- That the proper dialyzer is being used.
- That the dialysate flow rate is as prescribed.
- That the blood and dialysate lines are properly connected to the dialyzer so that the blood and dialysate flow are countercurrent (blood flow down, dialysate flow up).
- If the preceding is correct, check the patient's access flow rate (fistula or graft).

A substandard Kt/V could also indicate a problem with clotting, recirculation within the patient's access, or other problems.

While a treatment is in progress, the Kt/V may be increased by increasing the flow rate of the blood pump or increasing the dialysate flow rate. Changes to the prescribed treatment parameters, however, should be consistent with a physician's orders.



Note: The OLC self test should be run occasionally (1 – 2 times per month) or any time that you suspect that the OLC results may be erroneous.

Access Flow

How Access Flow is Derived

In order to determine the patient's access flow rate (AF), two OLC tests are done, one with the bloodlines connected in the normal position and one in the reversed position. In the reversed position, recirculation is induced. The higher the patient's access flow rate, the lower the recirculation. With the two OLC tests, the access flow rate can be calculated. The measurement is more accurate at lower access flow rates. Because it may be difficult to obtain high blood flow rates with the bloodlines in the reversed position, it may be necessary to reduce the blood flow rate for both tests. The result will be more accurate if both tests are done at the same blood flow rate.



Note: Fresenius Medical Care recommends using *Combiset bloodlines with Twister® blood flow reversal device* (P/N 03-2794-0) for treatments running access flow tests. The integrated Twister device eliminates the need to disconnect the bloodlines from the access during treatment. All blood flow direction changes are done aseptically within the Twister device.

How to run the Access Flow test

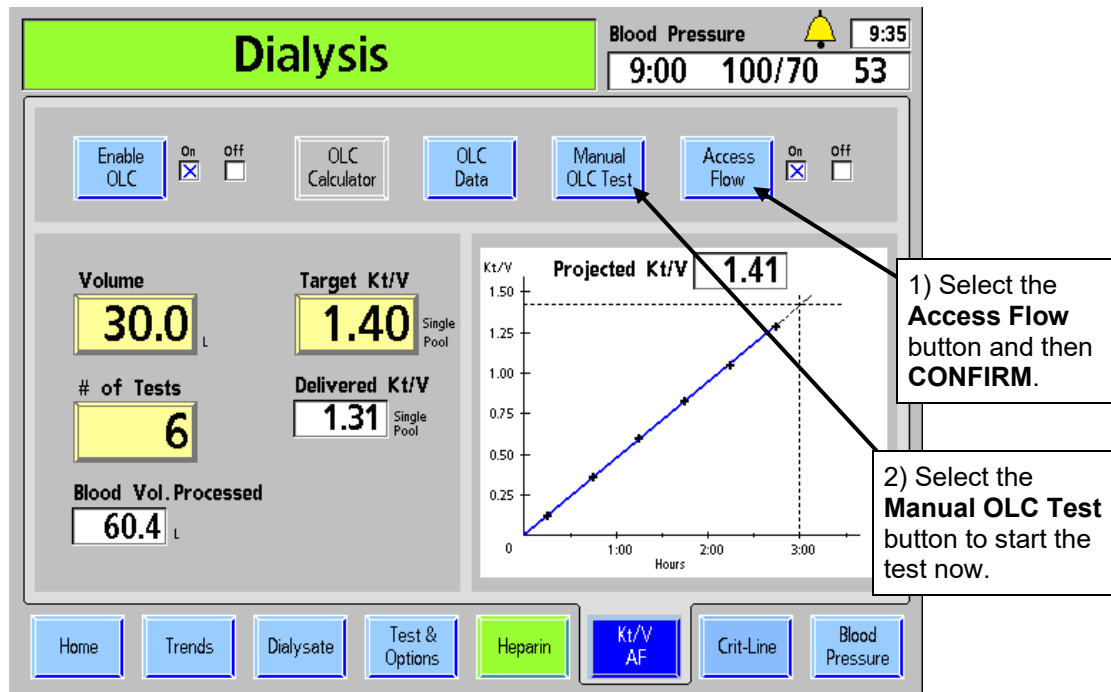

Figure 74 – Starting an Access Flow Test

When the **Access Flow** button is turned ON, the machine will offer to do the Access Flow test following the next OLC test. The **Access Flow** button may be left in the Off position and turned On later. If desired, select the **Manual OLC Test** and press **CONFIRM** after turning the Access Flow ON to begin the test right away. If you display the “Kt/V AF” screen while doing the test, more detailed instructions are displayed.



Warning! The Access Flow procedure requires that the bloodline connections to the access needles be reversed and later returned to their original position. To avoid the possibility of significant blood loss, be sure that the connections are well secured after disconnecting and reconnecting the bloodlines.

Warning! Use aseptic technique when doing this procedure.

Warning! Return the bloodlines to the original position (red to red and blue to blue) when the test is completed. Failure to do so will result in lower delivered therapy.



Note: If the access flow rate is less than or equal to the blood pump rate, the access flow rate will be calculated and reported as approximately the blood pump rate. In this case, the access flow rate may be lower than indicated.

Note: During the second OLC measurement for the Access Flow test, the UF will change to 70 if running low flux or 300 if running high flux.

OLC Data Subscreen

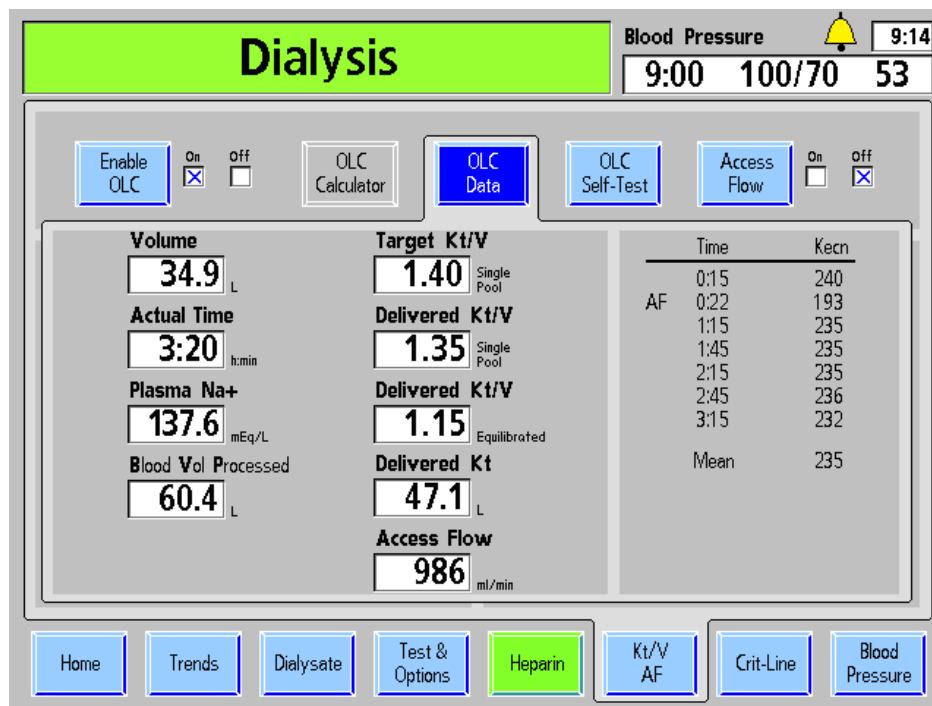

Figure 75 – OLC Data Subscreen

The OLC Data subscreen provides the actual clearance data of the treatment.

Table 29 – The OLC Data Subscreen Features

Feature	Function
Volume 	The calculated, urea-distribution, fluid volume of the patient. This is the same volume entered in the “Kt/V AF” screen.
Actual Time 	This data box displays in hours and minutes the amount of time the patient has been on dialysis.
Plasma Na+ 	This data box displays the OLC-calculated value for plasma sodium after the first OLC test. Note: If the Service Mode ‘Plasma Na+ Hide/Show’ option is set to ‘Hide’, this data box will not be displayed on the “OLC Data” subscreen. For more information, see page 315.
Blood Vol Processed 	This value indicates the total blood volume (in liters) that has passed through the dialyzer based on the blood pump flow rate and adjusted for negative arterial pressure.

Feature	Function																		
Target Kt/V <div style="border: 1px solid black; padding: 2px; display: inline-block;"> 1.40 </div> Single Pool	The value displayed here is the same value entered in the Target Kt/V button in the “Kt/V AF” screen.																		
Delivered Kt/V <div style="border: 1px solid black; padding: 2px; display: inline-block;"> 1.35 </div> Single Pool	This data box displays the current calculated amount of single pool Kt/V delivered therapy.																		
Delivered Kt/V <div style="border: 1px solid black; padding: 2px; display: inline-block;"> 1.15 </div> Equilibrated	This data box displays the calculated equilibrated Kt/V. It is calculated one hour after the beginning of treatment. The box remains blank until then.																		
Delivered Kt <div style="border: 1px solid black; padding: 2px; display: inline-block;"> 47.1 </div> L	This data box displays the value for the equation (time weighted mean Kecn) x (current time).																		
Access Flow <div style="border: 1px solid black; padding: 2px; display: inline-block;"> 986 </div> ml/min	This is the result of the Access Flow test. It is limited to <2000 ml/min.																		
<table border="1" style="width: 100%; border-collapse: collapse;"> <thead> <tr> <th style="width: 30%;">Time</th> <th style="width: 70%;">Kecn</th> </tr> </thead> <tbody> <tr> <td></td> <td>240</td> </tr> <tr> <td>AF 0:15</td> <td>193</td> </tr> <tr> <td>1:15</td> <td>235</td> </tr> <tr> <td>1:45</td> <td>235</td> </tr> <tr> <td>2:15</td> <td>235</td> </tr> <tr> <td>2:45</td> <td>236</td> </tr> <tr> <td>3:15</td> <td>232</td> </tr> <tr> <td>Mean</td> <td>235</td> </tr> </tbody> </table>	Time	Kecn		240	AF 0:15	193	1:15	235	1:45	235	2:15	235	2:45	236	3:15	232	Mean	235	<p>Data Table—This table displays the individual and mean Kecn data for the OLC and Access Flow tests. Time refers to when the tests was performed in respect to amount of time (hours/min.) elapsed from the beginning of treatment.</p> <p>Manual tests are preceded with “M”.</p> <p>Tests done for Access flow with the lines reversed are preceded with “AF”. These tests are not used in the Mean Kecn value.</p>
Time	Kecn																		
	240																		
AF 0:15	193																		
1:15	235																		
1:45	235																		
2:15	235																		
2:45	236																		
3:15	232																		
Mean	235																		

Blood Temperature Monitor / Blood Volume Monitor Screen

肆



Note: The 208T hemodialysis machine is set up in Service Mode to display either the “BTM BVM” screen or the “Crit-Line” screen. If the second to last screen-button along the bottom of the display screen shows “Crit-Line” instead of “BTM BVM,” see the “Crit-Line Screen” on page 157.

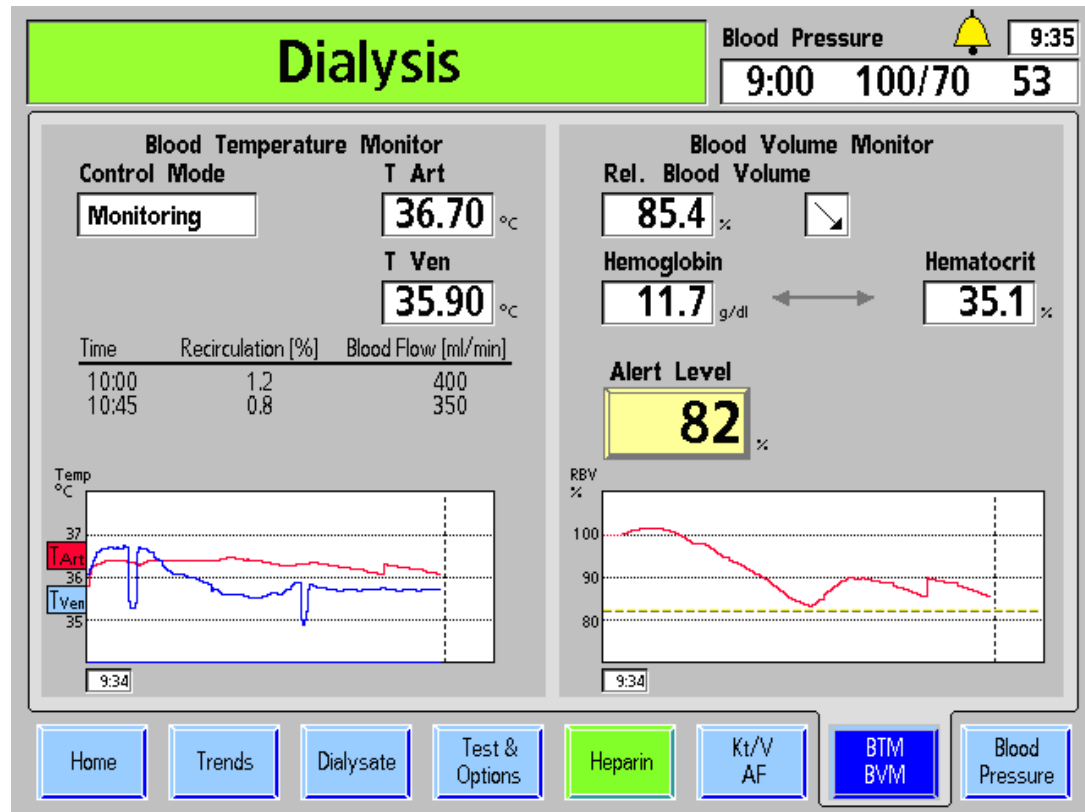

Figure 76 – BTM and BVM Monitoring Screen



The Blood Temperature Module (BTM) is an optional and separate device with its own Operator’s Manual. For a complete understanding of the functions of the BTM, please refer to P/N 470164. The BTM functions utilize the keys on the module itself for operation. The display screen is used only for displaying the results and operations of the BTM; none of the parameters are entered outside the BTM module.

The Blood Volume Module (BVM) is an optional and separate device with its own Operator’s Manual. For a complete understanding of the functions of the BVM, please refer to P/N 490041. The BVM functions utilize the keys on the module itself for operation. In addition, the display screen is used to display a graphical representation of the blood volume over time and to select the alert level where a Low Alarm will occur.

BTM function

The BTM has two primary functions – to regulate the patient’s temperature (energy) and to use temporary changes in dialysate temperature to determine the extent of recirculation at the blood access site.

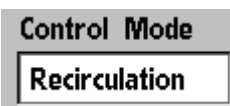
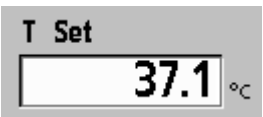
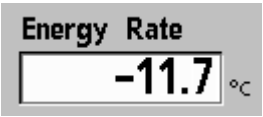
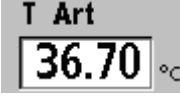

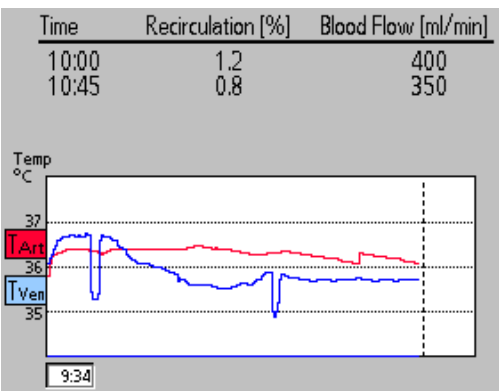
Table 30 – The BTM Data Screen Features

Feature	Function
	This area will display “Recirculation” when a recirculation test is being done. When there is no control program, it will read “Monitoring.” It will read “Temperature” or “Energy” when in a temperature or energy control mode.
	When performing a recirculation measure, the data box will display the T set value that the dialysate will reach. When in a temperature control mode, this area will display the rate of temperature change prescribed to warm or cool the patient in °C/h.
	When in an energy control mode, this display will indicate the energy flux to or from the patient in kilojoules per hour (kJ/h).
	This displays the arterial bloodline temperature as reported by the BTM module.
	This displays the venous bloodline temperature as reported by the BTM module.
	The table above the graph will display up to 3 recirculation values. This graph shows the arterial temperature in red and the venous temperature in blue. During recirculation tests the temperature will show changes for a short period of time. The vertical dotted line indicates the scheduled end of treatment.



Note: When the 2008T hemodialysis machine is first turned on, the small display on the BTM will indicate 1107. This is a normal event and can be cleared by pressing the Up Δ (Error) and Down ∇ (Result) keys on the BTM module at the same time.

Table 31 – The BVM Screen Features

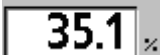
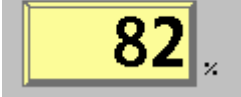
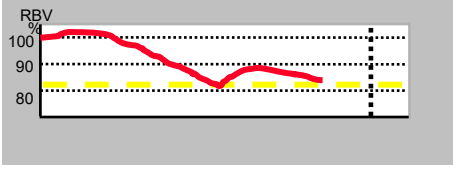
Feature	Function
<p>Rel. Blood Volume</p> 	<p>The Relative Blood Volume (RBV) is the relation of the current blood volume and the blood volume on the start of dialysis expressed in %. Thus, RBV is always 100% in the beginning. If at the end of the dialysis, RBV is e.g. 80%, the blood volume has been reduced by 20%. There can also be values of above 100%.</p>
	<p>The Trend Indicator is an arrow, which roughly shows the current direction and intensity of blood volume change. On the display the arrow is shown to the right of the measured value for RBV. The arrow symbols have the following meanings:</p> <ul style="list-style-type: none"> ↑: significant increase ↗: moderate increase →: nearly constant ↘: moderate decrease ↓: significant decrease
<p>Hemoglobin</p>  <p>Hematocrit</p> 	<p>The red blood cells (erythrocytes) are responsible for the transport of gases in the blood (oxygen and carbon dioxide). Hemoglobin, an iron compound giving the erythrocytes their red color, is the active component in this process.</p> <p>The hematocrit (HCT) is the packed cell volume (almost exclusively of erythrocytes) in the blood volume.</p>
<p>Alert Level</p> 	<p>This button allows to set a patient individual Alert Level for RBV. The range is 70% to 100%. Entering zero deactivates the alert function.</p> <p>If RBV reaches the Alert Level, the machine will give an audible alarm and will stop ultrafiltration. Press Reset to turn the Ultrafiltration pump back on. This alarm occurs only once if the user does not set another Alert Level.</p>
	<p>This graph shows the Relative Blood Volume in red. During time periods when the BVM can't determine RBV (e.g. saline flush) the red line will continue dotted with the last transferred value. The yellow dotted line shows the alert level. The vertical dotted line indicates the scheduled end of treatment.</p>

Crit-Line Screen



Note: The 2008T hemodialysis machine is set up in Service Mode to display either the “BTM BVM” screen or the “Crit-Line” screen. If the second to last screen-button along the bottom of the display screen shows “BTM BVM” instead of “Crit-Line,” turn to page 154.

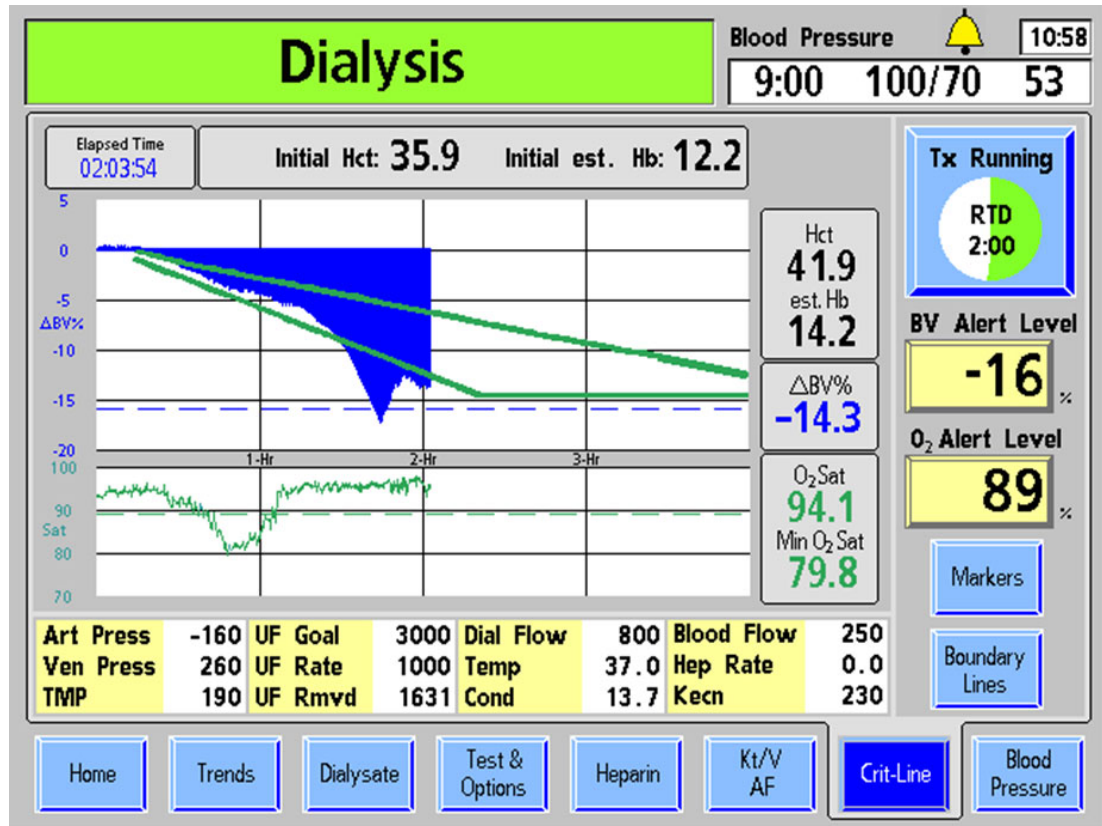

Figure 77 – Crit-Line Screen (Showing BV with Boundary Lines and O₂ Saturation) (Showing functional software version 2.74 or later)

The Crit-Line in a Clip (CLiC) device is used to non-invasively measure a hemodialysis patient’s hematocrit, oxygen saturation and percent change in blood volume. These measurements occur in real time in order to provide a more effective treatment. The measurements are displayed on the 2008T hemodialysis machine’s “Crit-Line” screen. Under the direction of a physician, the clinician/nurse can increase or decrease the ultrafiltration (UF) rate in order to remove the maximum amount of fluid without the patient experiencing the common dialysis related complications which include hypotension, nausea, cramping and vomiting.

The system consists of software for the 2008T hemodialysis machine, a Crit-Line in a Clip (CLiC) device, a CLiC device-specific verification filter which is used to calibrate and verify the CLiC device, and a disposable Crit-Line Blood Chamber. For more information, see the *2008T Hemodialysis Machine with CLiC User’s Guide* (P/N 490206).



Note: The CLiC device is only a tool used to complement a treatment on the 2008T hemodialysis machine. Operators must rely on their own clinical assessment of the patient to administer the treatment, as per the standard of care.

Reading Graphs on the “Crit-Line” Screen

The “Crit-Line” screen can display either Blood Volume (BV) (see Figure 77 on page 157) or Hematocrit (Hct) (see Figure 78 below) on the upper graph depending on the Service Mode setting.

On the lower graph, the Oxygen Saturation (O₂ Sat) graph can be changed to display blood pressures by selecting the graph and pressing the **CONFIRM** key.

The BV and O₂ Sat graphs are displayed by default.

Graphing of the data begins after the CLiC device reads blood sensed and the hematocrit has been stable for sixty seconds with the Tx Clock and blood pump running. Graphs are displayed for a minimum of four (default) and a maximum of ten hours. The Hct and O₂ Sat graphs are resized vertically during the treatment depending on the min/max values, and alert levels.

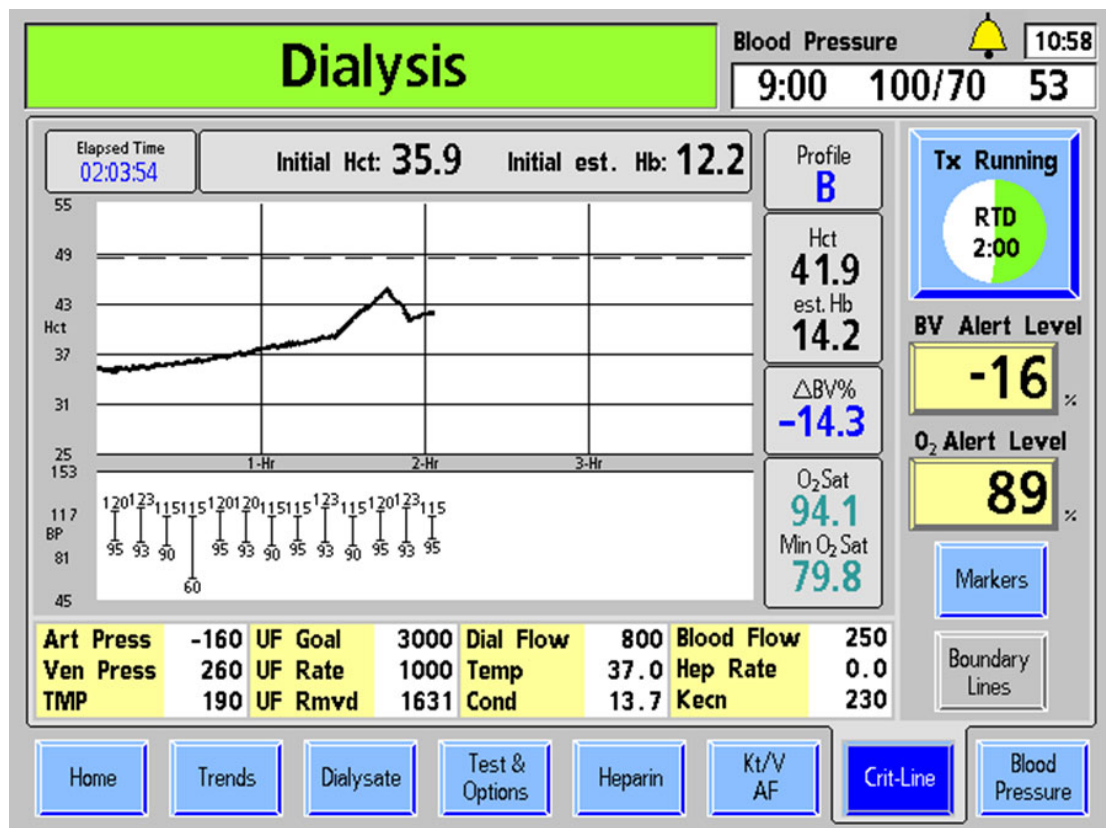



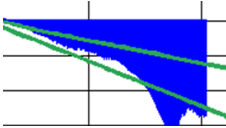







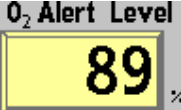







Figure 78 – Crit-Line Screen (Showing Hct and BP) (Showing functional software version 2.74 or later)

The table on the next page lists features common to all graph displays:

Table 32 – Crit-Line Screen Graph Features

Feature	Function
	<p>Elapsed Time – The time the Tx Clock and CLiC device are running. If the Tx Clock is paused or an event pauses the treatment (such as blood alarms), then the Elapsed Time is paused along with CLiC device data collection.</p>
	<p>Initial Hct – The starting hematocrit (Hct) value is recorded along with the first data point when graphing begins.</p>
	<p>Initial est. Hb – The estimated starting hemoglobin (Hb) value is recorded along with the first data point when graphing begins. It is calculated based on the hematocrit reading.</p>
	<p>Boundary Lines – If enabled by pressing the Boundary Lines button, these two green lines on the BV graph show where a per hour drop of -3% and -6.5% in relative blood volume would be. The lower line does not go below a -15% drop for the entire treatment. The two lines are displayed at the beginning of treatment, but do not cover the first 15 minutes of treatment (see Figure 77). After four hours of treatment, the boundary lines disappear.</p> <p>When boundary lines are displayed, the blood volume change profile letter (A, B or C) is not shown.</p>
	<p>Current blood volume change profile – The profile starts calculating after the first two blood volume measurements and is computed over the previous 15 minutes of data. The profile can be:</p> <ul style="list-style-type: none"> A BV change is less than or equal to -3% per hour (default) B BV change is more than -3% and less than or equal to -6.5% per hour C BV change exceeds -6.5% per hour <p>This letter does not appear on the BV graph when boundary lines are enabled.</p>
	<p>Current Hematocrit value.</p>
	<p>Current estimated Hemoglobin value calculated from the current Hematocrit: $Hb = Hct/2.94$</p>
	<p>Blood Volume Change – The percent change in blood volume since the start of the treatment. The BV change value is calculated from the following equation: $\Delta BV\% = [(Hct\ initial/Hct\ current) - 1] \times 100$</p>
	<p>BV Alert Level button – Sets the BV (Blood Volume) Alert Level (under physician direction). When the current $\Delta BV\%$ change drops below the set BV alert level, the 2008T hemodialysis machine stops the UF pump and displays the alert message “Rel. Blood Volume Low”. The alert can be cleared by lowering the alert level or by setting the BV Alert Level to OFF. After clearing the alert, the UF pump will automatically turn back on to the UF Rate set on the “Home” screen.</p>

Feature	Function
	<p>To set the BV Alert Level, select the BV Alert Level button and enter the desired value using the ↑ or ↓ (up or down) keys or the numbers on the keyboard and press the CONFIRM key. To turn the BV Alert level OFF, enter “0” (zero) on the keyboard and press the CONFIRM key.</p> <p>The BV Alert Level can be set from -1 to -20 or 0 for OFF. The default setting is -15. The BV alert level is drawn as a blue dotted line across the BV graph. If the Hct graph is instead displayed, the BV alert level appears as a black dotted line after the initial Hct is determined.</p>
	<p>Current Oxygen Saturation value.</p>
	<p>Minimum Oxygen Saturation – The minimum oxygen saturation value over all data points.</p>
	<p>O₂ Alert Level button – This button sets the oxygen saturation alert level. When the current O₂ Sat value drops below the O₂ Alert Level, the alert message “Oxygen Saturation Low” is displayed in the Status Box. The alert can be cleared by lowering the alert level or by setting the O₂ Alert Level to OFF.</p> <p>To set the O₂ Alert Level, select the O₂ Alert Level button and enter the desired value using the ↑ or ↓ (up or down) keys or the numbers on the keyboard and press the CONFIRM key. To turn the O₂ Alert level OFF, enter “0” (zero) on the keyboard and press the CONFIRM key.</p> <p>The O₂ Alert Level defaults to 89 and can be set from 45 to 95. Setting the O₂ Alert Level to any value 44 or lower turns the O₂ Alert Level OFF. The O₂ Alert Level is drawn as a green dotted line across the Oxygen Saturation graph.</p>
	<p>Markers button – Selecting this button displays a menu to insert an event marker on the BV (or Hct) and O₂ Sat graphs. Use the ↑ or ↓ (up or down) keys on the keyboard to select either ‘Symptom’ or ‘Intervention’. Pressing the CONFIRM key places the marker and the current ΔBV%, Hct, and oxygen saturation values on the latest point on the graph; pressing the Escape key exits the menu without placing a marker.</p> <ul style="list-style-type: none"> • The Symptom marker is displayed as a yellow diamond  • The Intervention marker is displayed as a black triangle  <p>Note: Markers can only be set when the Tx Clock is running and the CLiC device is not disabled. Resizing the graph may cause markers to rotate in order to better fit the space depending on the limits. If there is not enough space between markers, the machine will not place a marker in order to prevent overlap.</p>
	<p> Note: Wireless printing is not available for 2008T hemodialysis machines with software version 2.81 or later. Please contact your sales representative concerning other options for retrieving treatment data.</p>

Feature	Function
	Boundary Lines button – Selecting this button displays two green lines on the BV graph showing where a per hour drop of -3% and -6.5% in relative blood volume would be. Selecting it again removes the lines. This button is disabled when the BV graph is not shown.

The BV (Blood Volume) graph

The BV (Blood Volume) graph (Figure 77 on page 157) is displayed as a fill graph. A line is filled from 0 to the Δ BV% value. As the dialysis treatment progresses, fluid is taken out of the blood by the 2008T hemodialysis machine's ultrafiltration pump. This will result in a greater percentage of the blood being red blood cells and the blood volume fill graph will trend downwards and approach the alert level. The BV alert level is drawn as a blue dotted line across the BV graph.



Note: The BV graph is the default upper graph displayed on the “Crit-Line” screen. To display the Hct graph instead of the BV graph, call a qualified service technician.

The Hct (Hematocrit) graph

The Hct (Hematocrit) graph is a line graph (Figure 78 on page 158) drawn from the previous hematocrit value. As the dialysis treatment progresses, fluid is taken out of the blood by the 2008T hemodialysis machine's ultrafiltration pump. This will result in a greater percentage of the blood being red blood cells and the hematocrit line graph will trend upwards and approach the alert level.

The Hematocrit Alert Level is drawn as a black dotted line across the Hct graph. The Hematocrit Alert Level cannot be set directly, but is calculated from the BV Alert Level (see the **BV Alert Level** button on page 159). The line will appear on the graph after the initial Hct is determined. When the alert is triggered, the 2008T hemodialysis machine stops the UF pump and displays the alert message “Rel. Blood Volume Low”. The alert can be cleared by lowering the alert level or by setting the BV Alert Level to OFF. After clearing the alert, the UF pump will automatically turn back on to the UF Rate set on the “Home” screen.

The O₂ Sat (Oxygen Saturation) graph

Oxygen saturation is the default display on the “Crit-Line” screen's bottom graph. The O₂ Sat (Oxygen Saturation) graph (Figure 77 on page 157) is a line graph drawn from the previous oxygen saturation value. The O₂ Alert Level is drawn as a green dotted line across the Oxygen Saturation graph.



Note: To switch between the O₂ Sat graph and the BP graphs, select the graph. The message “Press Confirm to switch to O₂ graph. Press Escape to return to BP graph.” or “Press Confirm to switch to Blood Pressure graph. Press Escape to return to O₂ graph.” is displayed. Press the **CONFIRM** key to confirm the selection.

To switch back to the previous graph, select the graph again and press the **CONFIRM** key to confirm the selection.

The BP (Blood Pressure) graph

Similar to the Blood Pressure graph on the “Trends” and “Blood Pressure” screens, the BP (Blood Pressure) graph (Figure 78 on page 158) is drawn as a series of black dumbbells between the systolic and diastolic blood pressures. On the “Crit-Line” screen, the systolic (upper) and diastolic (lower) numbers are also displayed. If the value is out of range (as specified by the parameters on the “Blood Pressure” screen), the dumbbell will be drawn in red.



Note: If there is not enough space between blood pressure measurements, the blood pressure graph will not display a measurement in order to prevent overlap.

Note: Markers do not appear on the Blood Pressure graph.

Monitoring the hemodialysis treatment from the “Crit-Line” screen

Most of the commonly viewed data from other screens are grouped on the “Crit-Line” screen for convenient monitoring. Listed below are the features of the “Crit-Line” screen that can also be found on other screens.

Table 33 – Crit-Line Screen Features Found on Other Screens

Feature	Description
Art Press	Arterial Pressure – The value displayed on the “Home” screen (mmHg)
Ven Press	Venous Pressure – The value displayed on the “Home” screen (mmHg)
TMP	TMP (Transmembrane Pressure) – The value displayed on the “Home” screen (mmHg)
UF Goal	UF Goal – The UF goal selected for the treatment and set on the “Home” screen (ml)
UF Rate	UF Rate – The UF rate selected for the treatment and set on the “Home” screen (ml/h)
UF Rmvd	UF Removed – The UF removed at a given point in the treatment and displayed on the “Home” screen (ml)
Dial Flow	Dialysate Flow – The dialysate flow rate selected for the treatment and set on the “Home” screen (ml/min). The dialysate flow rate can also be turned on or off from the “Dialysate” screen.
Temp	Temperature – The temperature of the dialysate as displayed on the “Home” screen (°C)
Cond	Conductivity – The conductivity of the dialysate as displayed on the “Home” screen (mS/cm)
Blood Flow	Blood Flow Rate – The current blood pump rate (ml/min)
Hep Rate	Heparin Rate – The heparin pump rate set on the “Heparin” screen (ml/h) Note: As on the “Heparin” screen, this value will flash when the heparin pump is off unless both the “Heparin” screen Rate and Infusion Time buttons are set to 0 (zero).

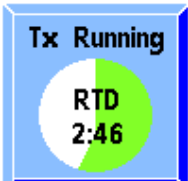
<p>Kecn</p>	<p>Kecn – The current Kecn (amount of sodium clearance) measurement. The Kecn is also displayed on the “Kt/V AF” screen’s “OLC Data” subscreen.</p>
 <p>The image shows a square button with a blue border. Inside, there is a pie chart that is half green and half white. Above the pie chart, the text 'Tx Running' is written in black. Below the pie chart, the text 'RTD 2:46' is written in black.</p>	<p>Treatment (Tx) Clock – This button runs or pauses the treatment and displays the Remaining Time of Dialysis (RTD). The green segment of the pie chart represents the amount of treatment completed and grows as the treatment progresses. The Tx Clock button and an RTD button to set the RTD are also located on the “Home” screen.</p>

Blood Pressure Screen Monitoring

The results of tests performed with the Blood Pressure module are recorded on the left side of the “Blood Pressure” screen (see Figure 79).

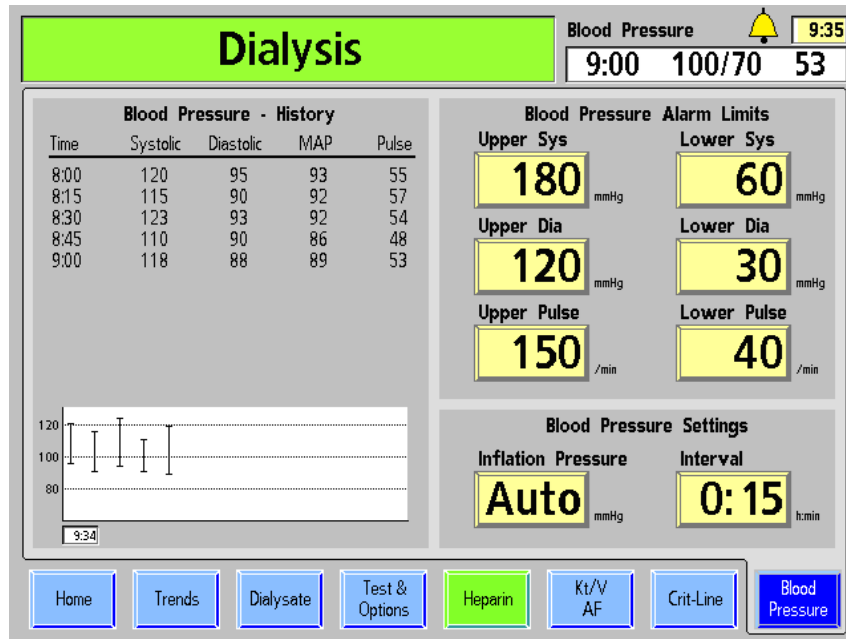

Figure 79 – Blood Pressure Screen

The blood pressure readings are displayed both in table and graph form (the graph can also be viewed in the “Trends” screen). The table lists the time the blood pressure reading was taken, the systolic and diastolic pressures, the Mean Arterial Pressure (MAP), and the pulse rate of the patient during the test. The MAP is measured by the blood pressure module and thus may differ from MAP calculated from systolic and diastolic pressure.

The pressure readings on the graph are represented by vertical lines with ticks at the top and bottom signifying the systolic and diastolic pressures respectively. The first pressure reading is displayed on the left side of the graph with subsequent readings appearing to the right. The table on screen displays a maximum of 10 pressure readings at a time.



The **Stat/Deflate** key, located on the right side of the control panel, can be used to quickly relieve the pressure from an inflated blood pressure cuff. It will also start an unscheduled blood pressure reading if the cuff is deflated. Unscheduled tests do not have any effect on the scheduled tests. For example, if the tests were scheduled at 15-minute intervals, and a manual test was taken five minutes after the first test, the next test will still occur 15 minutes after the first one. The results of both automatic and manual tests are displayed in the table. Results appear in the graph only after the Tx Clock is started.



Warning! Too frequent measurements can cause injury to the patient due to blood flow interference. During patient treatment, regularly check that operation of the automated blood pressure monitoring subsystem does not result in prolonged impairment of the patient's blood circulation.

During Treatment

Online Pressure Holding Test

The online Pressure Holding Test (PHT) automatically checks the integrity of the dialysate balancing system during dialysis when the dialyzer is connected. The online PHT detects most leaks in the hydraulics that would affect the precise volumetric control of fluid in the dialysate system.

The online PHT complements the self-test sequence; it is not a substitute. It is still necessary to perform the initial Automatic Test Sequence before each high flux treatment.

The online PHT runs every 12 minutes regardless of the other alarm conditions. Dialysate flow must be on and the machine cannot be executing a filling program or OLC test. The test runs for two balancing-chamber cycles (about seven seconds). The message “Running Online PHT” displays during the test. Before the test, the UF pump stops in the middle of a cycle and remains off during the two balancing chamber cycles of the online PHT. The UF green light will flash during this time. The machine is in bypass mode during the test period. The displayed TMP during this time represents pressure within the hydraulics, therefore, the TMP reading may change slightly. The TMP alarm limits are spread during the test.

Online PHT Failure

If the machine fails the online PHT, the message “Online PHT Failed” is displayed in the Status Box. The blood pump does not stop during this Low Alarm condition. This alarm can be cleared by pressing the **Reset** button.

Online PHT failures can be caused by problems that make it difficult to control the patient’s fluid balance. Some failure alarms can be caused by air entering the hydraulic system from faulty concentrate or dialyzer line connections. The operator should inspect the machine for external air intake and fluid leaks, and make the appropriate corrections if possible.

Discontinue the treatment and take the machine out of service if an online PHT failure alarm recurs. The hydraulics should be inspected by a qualified technician before returning the machine to service.

If an online PHT failure occurs once during a treatment, perform the Pressure Test (from the “Test & Options” screen) before the next treatment to verify the integrity of the hydraulic system.

Changing the *bi*bag disposable during treatment



Note: When changing the *bi*bag disposable during treatment, the automated empty feature cannot be used so the bag will need to be emptied manually.

Note: If a bag is changed during treatment, a pause of 6-10 minutes should be expected as the new bag fills. The dialysis machine will automatically go into bypass mode until the new bag is on-line and conductivity comes into the acceptable range.

If the *bi*bag disposable needs to be changed during the treatment, use the following steps:

1. Lift up on the dark-gray *bi*bag door handle to open the *bi*bag door.
2. Wait 30 seconds to relieve the pressure in the bag.
3. Lift up the *bi*bag disposable by the handle, remove the used bag and dispose of it per unit protocol. Since the used bag is not empty of fluid, be careful to prevent spills.



Note: If disposing of leftover bicarbonate solution down a drain, be sure to run plenty of hot water down the drain too. This will help prevent bicarbonate buildup in the plumbing.

4. For the new *bi*bag disposable, remove the white plastic seal from underneath the water and bicarbonate nozzles. With the white *bi*bag handle facing outward, hang the *bi*bag disposable on the machine's *bi*bag connector nozzles. Push it down until it is fully seated on the *bi*bag connector nozzles.
5. Close the *bi*bag door, making sure it latches firmly in place. An audible click indicates the door is closed. The treatment will resume after the machine fills the bag with heated water.

Blood Recirculation Procedure

It is the responsibility of the unit's medical director to determine the appropriate anti-coagulation protocol and the maximum length of time for recirculating blood.

1. Return blood if possible

To recirculate blood within the extracorporeal blood circuit:

2. Select the **Tx Clock** button and press **CONFIRM** (to 'paused')
3. Press the blood pump **Start/Stop** key to stop the blood pump
4. Disconnect the arterial and venous bloodlines from access in an aseptic manner, and connect them together with a sterile recirculation connector.



Note: Infuse heparin per facility protocol.

5. Unclamp saline bag
6. Press the **Start/Stop** key to start the blood pump, and set the blood flow rate at 150–200 ml/min. An audible alarm will sound every five minutes to alert the operator that the Tx Clock is paused with blood sensed.
7. Press the **Reset** key to clear the alarm.

To reconnect the patient to machine:

1. Press the **Start/Stop** key to stop the blood pump.
2. Clamp the saline line.
3. Aseptically reconnect the arterial and venous bloodlines to the patient's access sites.
4. Restart the blood pump and adjust blood pump to the prescribed flow rate.
5. Select the **Tx Clock** button and press **CONFIRM** to resume the treatment.

Power Failure during Dialysis

In case of a power failure, the blood pump stops and the venous line clamp closes. The dialysate flow pump, heater, blood leak detector, and level detector are non-functional. All function lights go out. A steady, audible alarm will immediately sound for seven minutes that cannot be silenced with the **Mute** key. It can be silenced manually, however, by removing the 9-volt battery from the back of the machine.

Manually Operating the Blood Pump

In the event of a power failure during treatment, the 2008T blood pump can be manually operated to return the blood to the patient or to keep the blood in recirculation if a quick resumption of power is anticipated. Either option is accomplished with the auxiliary hand crank supplied with the machine (see Figure 80). The hand crank is attached to the back of the machine.

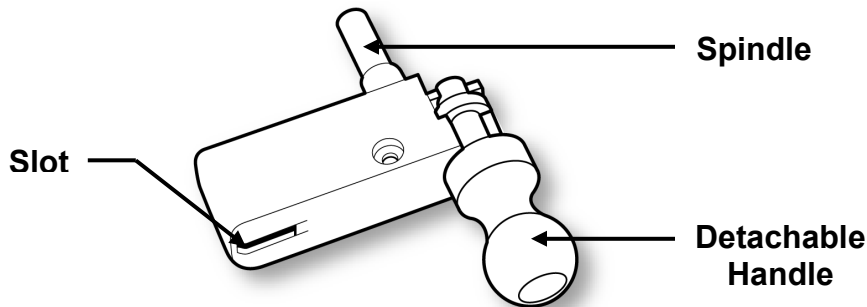

Figure 80 – Auxiliary Blood Pump Crank



Note: As a precaution, the handle will detach from the crank when attempting to turn the rotor in the wrong direction. An arrow embossed on the face of the pump-segment housing points in the correct direction of rotation (clockwise).

Returning the Blood to the Patient Manually

To return the blood manually:

1. Remove the bloodline from venous line clamp. If you are performing single-needle dialysis, remove the pump segment from the single-needle pump.
2. Replace saline bag with a fresh bag if necessary.
3. Using a hemostat, clamp the arterial bloodline directly above the saline “T”.
4. Open the saline line clamps and rinse the blood in the tubing below the saline “T” back to the patient. When the blood in the line has been rinsed back to the patient, close the saline line clamps.
5. Clamp the arterial bloodline directly under the saline “T”. Remove the clamp on the bloodline above the saline “T” and open the saline line clamps.
6. Open the pump door and flip the rotor latch outward (see Figure 81 #1).

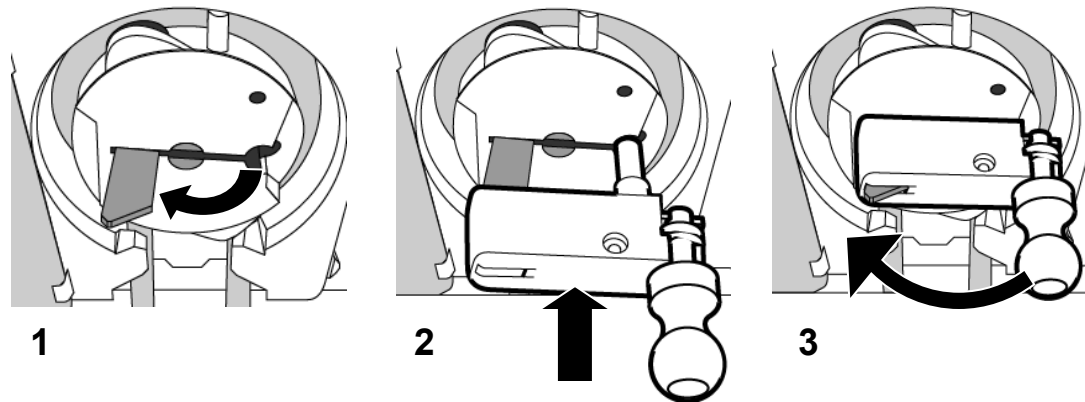

Figure 81 – Inserting the Blood Pump Crank

7. Align the slot and the spindle on the crank handle with the rotor latch and hole as shown in Figure 81 #2 above.
8. Slide the crank handle in as far as it will go. The crank latch will protrude slightly from the crank handle (see Figure 81 #3).
9. Rotate the crank clockwise and rinse back the blood with the saline according to unit protocol. The blood should be returned under strict visual control.



Warning! Carefully observe the venous chamber and bloodline for the presence of air. Be sure no air will be infused into the patient.

10. Clamp the arterial and venous bloodlines and the patient's arterial and venous access lines, and aseptically disconnect them.

Manual Circulation

To circulate the blood manually:

1. Remove venous line from clamp. Be sure no air will be infused into the bloodline. If you are performing single-needle dialysis, remove the pump segment from the single-needle pump.
2. Open the pump door and flip the rotor latch outward (see Figure 81 #1).
3. Align the slot and the spindle on the crank handle with the rotor latch and hole as shown in Figure 81 #2 above.
4. Slide the crank handle in as far as it will go. The crank latch will protrude slightly from the crank handle (see Figure 81 #3).
5. Rotate the crank clockwise at a rate of 6–10 rotations per minute. This is equivalent to a blood flow rate of 60–100 ml/min. Observe the venous chamber and bloodline to ensure that no air is infused in the patient. Manual circulation time is the responsibility of the clinic's medical supervisor.



Warning! Carefully observe the venous chamber and bloodline for the presence of air. Be sure no air will be infused into the patient.

Power Resumption Procedure

1. Press the **POWER** key to restore power to the machine. The screen displays the “Select Program” screen with the message, “Power Fail Recovery.”
2. Select the **Dialysis** button to enter the “Dialysate” screen.
3. In the “Dialysate” screen, check the conductivity settings (Base Na⁺, Bicarbonate, concentrate type) and alarm limits. Verify that the dialysate concentration settings are correct. If not, reset them.
4. Press **CONFIRM** to save the dialysate settings.
5. Select the **Home** button to display the “Home” screen.
6. Press the **Reset** key to reset any alarms. Conductivity and temperature alarms will reset automatically when acceptable limits are reached—usually in about 3–5 minutes. If the dialysate lines were disconnected, reconnect the dialysate lines when conductivity and temperature return to their prescribed limits.
7. Insert venous line in venous clamp and optical detector.
8. If not still connected, reconnect the patient per unit policy. If you are performing single-needle dialysis, re-insert the pump segment into the single-needle pump.
9. Press the blood pump **Start/Stop** key to restart the blood pump. Reset the blood pump to the prescribed flow rate.
10. Select the **Tx Clock** button and then press **CONFIRM** to resume dialysis.
11. If the heparin pump or the Single-Needle option were active prior to the power failure, reinitiate these functions upon power resumption.
12. The alarm settings are stored during a power failure. Adjust conductivity, arterial and venous pressure, and blood pressure alarm settings if necessary.
13. The SVS program parameters are stored during a power failure. Restart the SVS Profile program by selecting and confirming the desired SVS Profile. Adjust the SVS-Time if necessary.
14. The UF treatment parameters are also saved during a power failure. Check all parameters (UF Goal, UF Time, UF Rate, UF-Removed) for correct settings and adjust if necessary.

Completion of Dialysis

At the end of treatment, when the RTD timer has counted down to 0:00, a Low Alarm sounds and the message, “RTD = Zero”, appears in the Status Box. A Low Alarm also sounds when the set amount of ultrafiltrate has been removed. When that happens, the Status Box displays the message, “UF Goal Reached”. To reset either alarm, press the **Reset** key. If the “UF Goal Reached” and “RTD = Zero” alarms occur simultaneously, pressing the **Reset** key will reset both alarms.

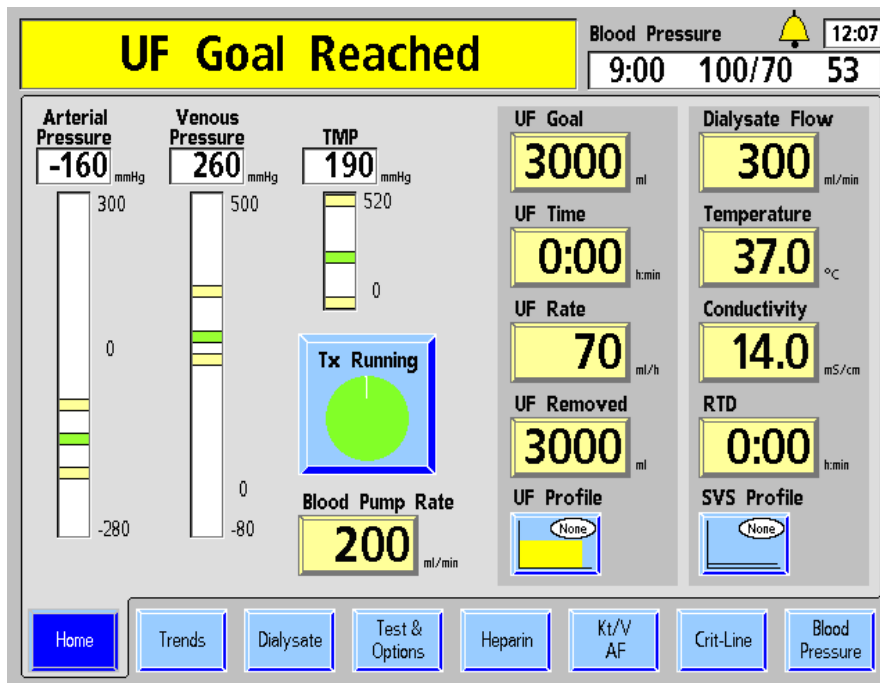

Figure 82 – End of Treatment (showing functional software version 2.72 or later)

When the UF Goal is reached, the UF Rate automatically drops to 70 ml/hr (or 300 ml/hr if the ‘High Flux’ option in the “Test & Options” screen is selected).

At the end of the treatment, the final updates are made to data displayed on the “Trends” screen. This data will be transferred to the PatientCard after the blood has been returned.

There are two ways to return the blood to the patient: the standard, unassisted method or the Assisted Reinfusion method (functional software version 2.72 or later). For instructions on using the Assisted Reinfusion feature, see page 173. To return the blood to the patient using the standard method, continue to the next page.

Returning Blood to the Patient (Standard Method)

1. Select the **Tx Clock** button and then press **CONFIRM** to stop the treatment.
2. Press the **Start/Stop** key on the blood pump to stop the pump.
3. Replace saline bag with a fresh bag if necessary.
4. Rinse the blood in the patient end of the arterial bloodline back to the patient:
 - a. Using a hemostat, clamp the arterial bloodline directly above the saline “T”.
 - b. Open the saline line clamps and rinse the blood in the tubing below the saline “T” back to the patient. When the blood in the line has been rinsed back to the patient, close the saline line clamps.
5. Rinse the remaining blood in the bloodline back to the patient:
 - a. Clamp the arterial bloodline directly under the saline “T”.
 - b. Remove the clamp on the bloodline above the saline “T” and open the saline line clamps.
 - c. Start the blood pump and set a rate of 150-200 ml/min.
 - d. When the blood has been returned to the patient, turn the blood pump off and close the saline line clamps.



Warning! Check all bloodlines and dialysate lines for leaks. Keep access sites uncovered and monitored. Improper bloodline connections or needle dislodgements can result in excessive blood loss, serious injury, and death. Machine alarms may not occur in every blood loss situation.

6. Clamp the arterial and venous bloodlines and the patient’s arterial and venous access lines, and aseptically disconnect them.

If the PatientCard was used to program the treatment, the 2008T hemodialysis machine will now attempt to save the treatment data.

If a *bi*bag disposable is connected to the machine, it should be emptied at this time. Afterward, the dialyzer may be emptied and the bloodlines must be removed from the machine.

To empty the *bi*bag disposable, turn to page 177.

Or, to remove the dialyzer, turn to page 178.

Returning Blood to the Patient Using Assisted Reinfusion

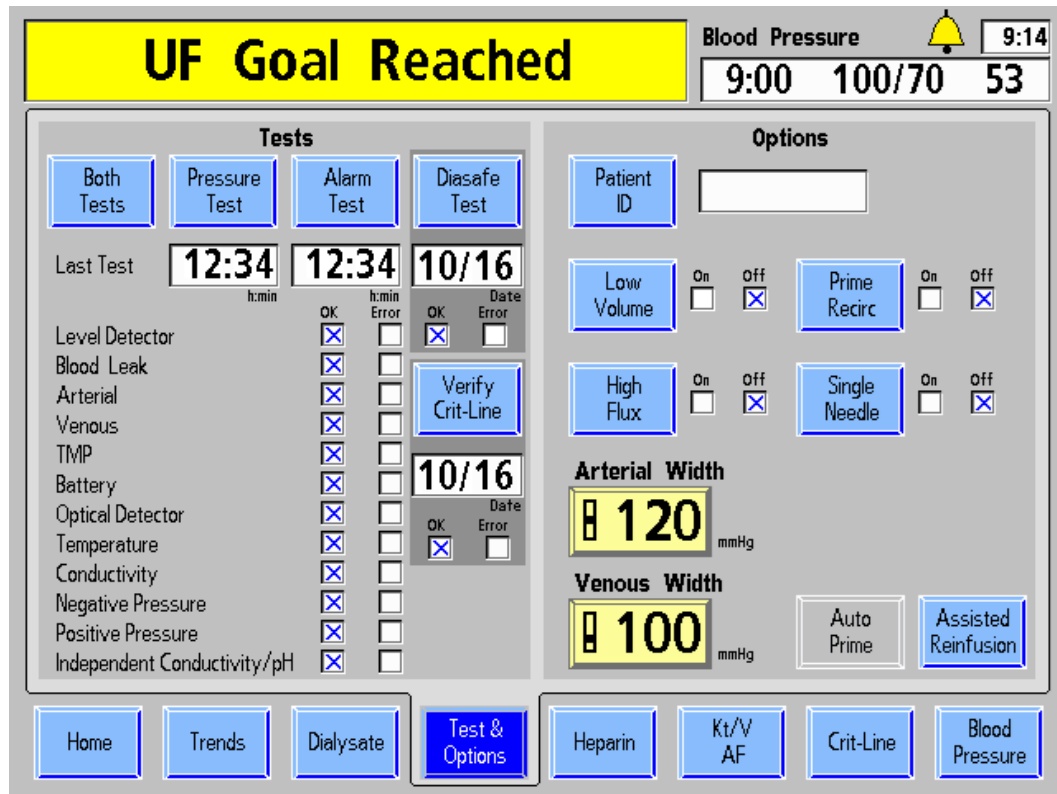

Figure 83 – Assisted Reinfusion Button on the Test & Options Screen

If the 'Assisted Reinfusion' option is set in Service Mode (functional software version 2.72 or later), the **Assisted Reinfusion** button is displayed on the "Test & Options" screen. This button becomes available when blood is sensed and is used to aid the operator in returning all of the patient's blood in the bloodlines.

Pause the Tx Clock, then select the **Assisted Reinfusion** button. This will stop the blood pump and display the first "Assisted Reinfusion" screen.

To begin returning the patient's blood, follow the on-screen instructions as described on the next page.



Note: The **Assisted Reinfusion** button is unavailable when the Single Needle option is set to 'On'.

Note: This procedure is shown using CombiSet bloodlines P/N 03-2722-9; if a different bloodline set is used, the clinic is responsible for providing instructions.

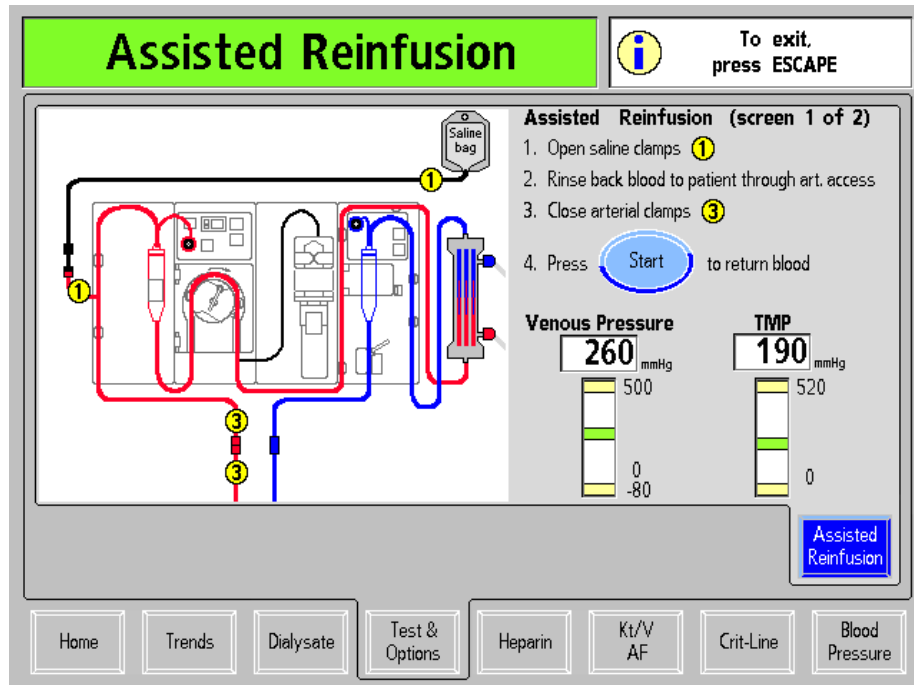

Figure 84 – First Assisted Reinfusion Screen

After selecting the **Assisted Reinfusion** button, the first “Assisted Reinfusion” screen is displayed (see Figure 84 above).



Note: Pressing the **Escape** key will exit the “Assisted Reinfusion” screens and display the “Test & Options” screen. To resume treatment, restart the blood pump at the prescribed rate and select and confirm the **Tx Paused** button on the “Home” screen to change it to ‘Tx Running’ once again.

Follow the on-screen instructions to return the patient’s blood:

1. Open saline clamps 1

Open each of the two clamps labelled ‘1’ in the on-screen diagram so saline can flow into the arterial bloodline.

2. Rinse back blood to patient through art. access

Rinse the blood in the patient end of the arterial bloodline back per clinic protocol.



Warning! Carefully observe the arterial bloodline for the presence of air. Be sure no air will be infused into the patient.

3. Close arterial clamps 3

When the blood in the arterial bloodline has been returned, close the two clamps on the arterial bloodline.

4. Press Start button to return blood

Press the **Start** button to start the blood pump. The blood pump will continue to run for a few seconds after saline has passed the optical detector in the Venous Clamp to ensure all the blood is returned through the patient’s venous access (if blood is still detected after four minutes, the pump will stop automatically).

The screen shows venous and TMP pressure bar graphs similar to the ones on the “Home” screen. Monitor the pressures when returning blood to the patient.

While the blood is being returned, it is possible to monitor the values shown on the Trends screen in real time (for software versions 2.72 or later). The values will be displayed as in the example below after the **Start** button is pressed.

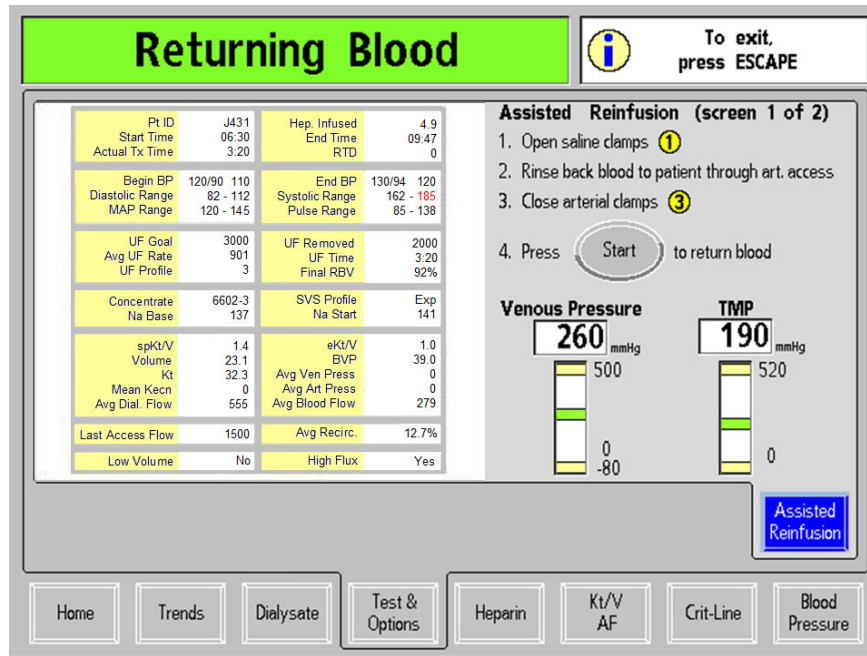

Figure 85 – First Assisted Reinfusion Screen with Trends Screen Values Displayed

To see a list of online clearance measurements of Kecn values, tap the Trends screen picture. The time and measurement value will be displayed as in the example below.

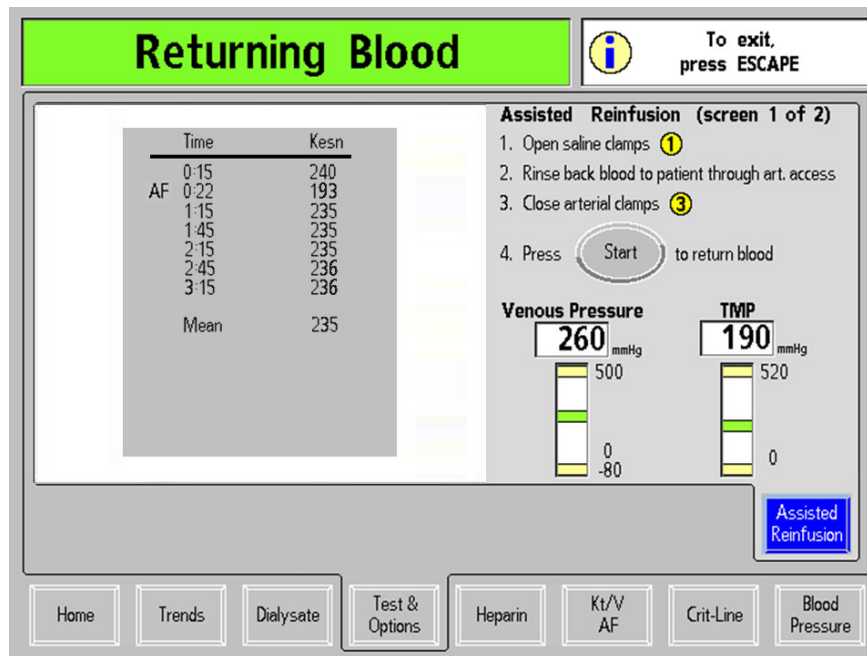

Figure 86 – First Assisted Reinfusion screen with Kecn values displayed

Tap this picture to return to the bloodline illustration, if desired. The Trends screen and the Kecn screen are not available during SLED programs.

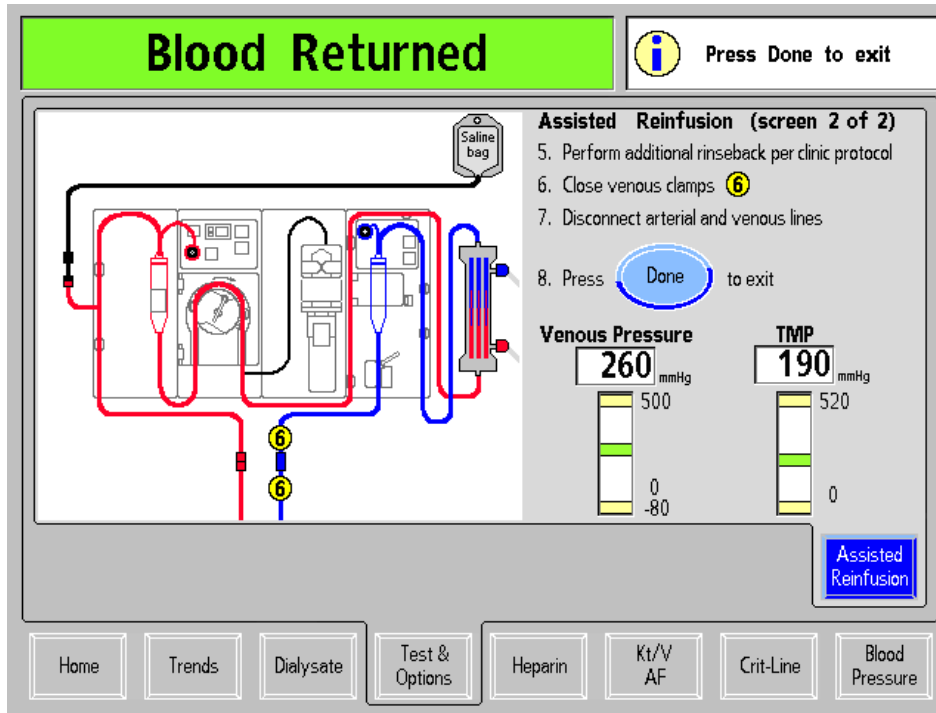

Figure 87 – Second Assisted Reinfusion Screen

5. Perform additional rinseback per clinic protocol

After the blood has been returned, the blood pump will stop running. Follow clinic protocol after the blood has been returned to rinse back any more saline if required. This additional rinseback may include a saline bolus if directed by clinic protocol.

6. Close venous clamps 6

Close the two venous clamps labelled ‘6’ in the on-screen diagram.

7. Disconnect arterial and venous lines

After the venous clamps are closed, disconnect the arterial and venous bloodlines and perform access site care.

8. Press Done button to exit

Press the **Done** button to exit the “Assisted Reinfusion” screen and return to the “Test & Options” screen.

If the PatientCard was used to program the treatment, the 2008T hemodialysis machine will now attempt to save the current treatment data.

If a *bi*bag disposable is connected to the machine, it should be emptied at this time. Afterward, the dialyzer may be emptied and the bloodlines must be removed from the machine.

To empty the *bi*bag disposable, turn to the next page.

Or, to empty the dialyzer, turn to page 178.

Emptying the bibag disposable

At the end of a *bibag*-based treatment, a blue **Empty bibag** button is displayed in the upper right corner of the “Dialysate” screen (see Figure 88) to empty the bag for easy disposal. Follow unit protocol or use this optional procedure to empty the *bibag* disposable at the end of a treatment.



Note: The Empty *bibag* feature cannot be used when blood is sensed or the Tx Clock is running. The **Empty bibag** button is also unavailable during a “*bibag*: Bag Leak” alarm.

Note: The *bibag* disposable may also be emptied manually; see page 166 for more information.

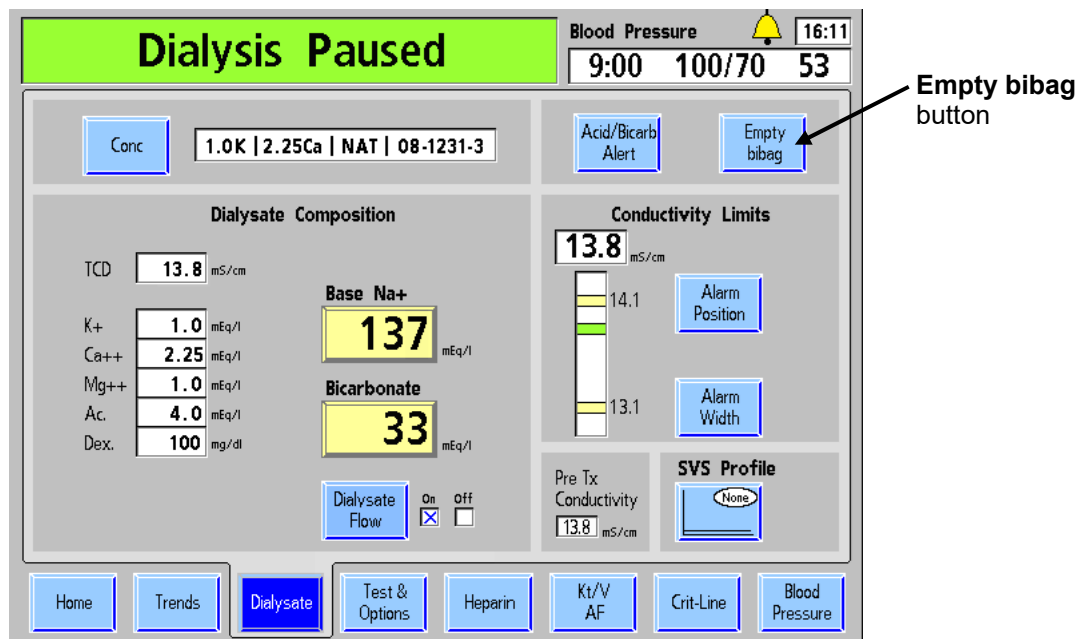

Figure 88 – Empty bibag button on the “Dialysate” screen

1. Select the **Empty bibag** button and press the **CONFIRM** key to begin emptying the *bibag* disposable. Any fluid remaining in the bag will be sent out the machine drain line.



Note: The *bibag* disposable and the dialyzer cannot be emptied at the same time. To run the Empty *bibag* program, both dialysate lines must either be on the shunt or on the dialyzer.

2. When the *bibag* disposable is empty of fluid, the Status Box will display the message, “*bibag*: Emptied”.
3. Lift up on the dark-gray *bibag* door handle to open the *bibag* door. Remove the bag and dispose of it per unit protocol.
4. Close the *bibag* door securely, making sure that the door latches into place (two clicks should be heard).

Next the dialyzer should be removed from the machine, turn to the next page.

Removing the Dialyzer

There are two procedures for removing the dialyzer depending on whether your facility reuses dialyzers. Follow the appropriate procedure for your situation.



Note: If the *bibag* disposable still needs to be emptied, see the instructions on page 177.

If Reuse is practiced

The dialysate compartment should not be emptied before cleaning the dialyzer. In such cases:

1. Open the shunt door and place the dialyzer connectors on the shunt. Pull on the dialyzer connectors to make sure they are firmly connected to the shunt. Close the shunt door.
2. Cap the dialyzer ports with the caps supplied with the dialyzer and process dialyzer as per unit protocol
3. Discard the bloodlines and transducer protectors according to facility policy; see the next page for instructions on removing the bloodlines from the machine.
4. Insert the concentrate connectors into their proper rinse ports. The “Select Program” screen will be displayed.
5. Clean or disinfect the exterior of the machine according to routine cleaning and maintenance procedures described in “Disinfection and Maintenance,” on page 180.

If Reuse is not practiced

To empty the dialyzer for dialyzer disposal:

1. Open shunt door and place the blue dialyzer connector to shunt interlock. Pull on the blue dialyzer connector to make sure it is firmly connected to the shunt.
2. Position the dialyzer so that the red, outlet port is at the bottom.
3. Close the shunt interlock door. The message “Emptying” will be displayed as the machine drains the dialysate compartment. The dialyzer is empty as soon as there is air in the outlet line or an “Emptying Stopped” message appears.
4. When the dialyzer is empty, open the shunt interlock door, remove red dialyzer connector from the dialyzer and place it on the shunt. Pull on the red dialyzer connector to make sure it is firmly connected to the shunt. Close the shunt interlock door.
5. Discard the bloodlines, transducer protectors, and dialyzer according to facility policy; see the next page for instructions on removing the bloodlines from the machine.
6. Insert the concentrate connectors into their proper rinse ports. The “Select Program” screen will be displayed.
7. Clean or disinfect the exterior of the machine according to routine cleaning and maintenance procedures described in “Disinfection and Maintenance,” on page 180.

Removing Bloodlines from the Machine

The arterial and venous ends of the bloodline should be clamped to avoid spillage before attempting to remove the lines from the system.



Caution: Do not forcefully pull the lines from the machine. Damage to the machine or its components may result.



Note: If the CLiC device was used for this treatment, pinch the CLiC device to spread the sensor elements apart and gently remove the device from the Crit-Line Blood Chamber. Store the CLiC device by clipping it to its verification filter, which is attached to its USB cable. Discard the disposable Crit-Line Blood Chamber with the rest of the bloodlines.

For more information, see the *2008T Hemodialysis Machine with CLiC User's Guide* (P/N 490206).

To remove the bloodline from the blood pump

See page 41 for a diagram of the Blood Pump module.

1. Open the blood pump door and align the rotor by pressing and holding the **Start/Stop** key until the pump stops.
2. Press the clamp-panel below the rotor to release the left (incoming) side of the pump segment.
3. Gently pull the first couple of free inches of the pump segment out of the pump.
4. While keeping firm tension outward on the left (incoming) side of the bloodline, press and hold the **Start/Stop** key a second time. The blood pump rotor will rotate again and the remaining pump segment will be released from the pump rotor.

To remove the bloodline from the Level Detector module's optical detector

See page 43 for a diagram of the Level Detector module.

1. Rotate open the optical detector door open.
2. Press down on the venous clamp lever and pull the bloodline from the venous clamp and optical detector assembly.
3. Open the level detector door and remove the venous drip chamber. Close the level detector door afterward.

Continue with Chapter 5 on the next page to clean and disinfect the machine.

Disinfection and Maintenance

This chapter covers all cleaning, disinfection, and maintenance tasks that can be performed by the operator. Included are instructions for running the programs found on the “Select Program” screen designed to clean and disinfect the fluid paths found in the 2008T hemodialysis machine.

The test procedures by which the effectiveness of disinfection has been verified are available on request.

Cleaning and Disinfection

Daily cleaning, chemical, and heat disinfection procedures should be performed to maximize the efficiency and minimize bacterial levels within the system. All rinsing, cleaning, and disinfection programs are selected from the right side of the “Select Program” screen (see Figure 89 below). The “Select Program” screen appears automatically after a long power down or when the concentrate connectors are inserted in their proper rinse ports after a treatment. The machine must be connected to an approved water source, the drain line connected to a drain, the dialysate supply lines on the shunt with the shunt interlock door closed, and the concentrate connectors are firmly seated in their respective ports. The ultrafiltration fluid sample port output tubing is part of the fluid pathway; therefore, flow exists during cleaning and disinfection. To run any of the Cleansing and Disinfection programs, select the appropriate button.

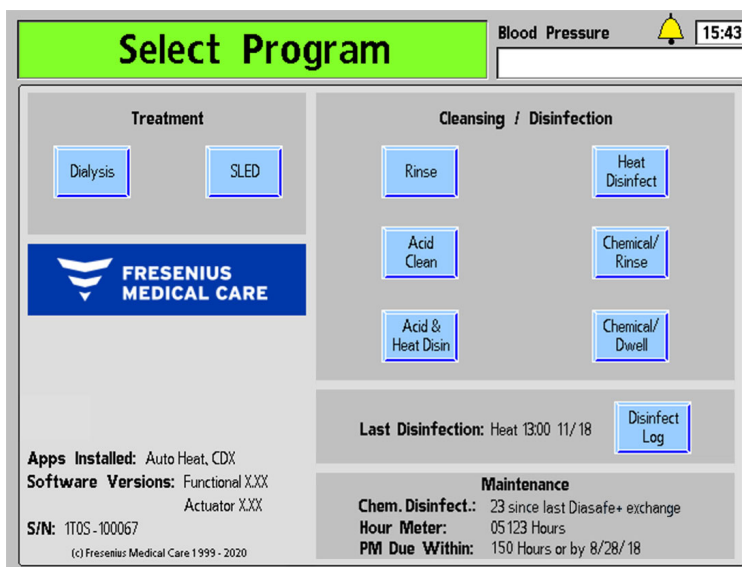

Figure 89 – The Select Program Screen (showing functional software version 2.81 or later)

The fluid path of the 2008T hemodialysis machine can be disinfected chemically or with heat. The machine should be rinsed thoroughly after chemical disinfection and before introducing any other chemicals to the machine. The machine should be heat disinfected at least once each day it is used and rinsed per unit protocol. If the machine is not in use for more than 48 hours, it should be disinfected before the next use or put in storage (for more information on storing the machine, see “Equipment Storage and Maintenance” on page 361). If there is evidence of a blood leak into the dialysate system, the machine should be disinfected before being used in any further treatments.

The Rinse program flushes the machine with water. The Acid Clean Program flushes the machine with a mild acid to remove bicarbonate build up. There are three options for disinfecting the interior of the 2008T hemodialysis machine—Heat Disinfect, Chemical/Rinse and Chemical Dwell.

All rinse, cleaning, and disinfecting programs can be interrupted by pressing the **Escape** key.









Functional software versions 2.69 or earlier show the time and date of the last heat disinfection. In functional software version 2.72 or later, the Last Disinfection section shows the time and date of the last heat disinfect or chemical/rinse program disinfection. An optional **Disinfect Log** screen-button (with 2008T BlueStar Premium) is also available to show the last 1,200 disinfection events stored on the machine. For more information about the “Disinfect Log” screen, see page 197.

The following table describes the cleaning and disinfecting options available on the “Select Program” screen. Follow the current, chemical manufacturer’s instructions for the proper use of the disinfectants.

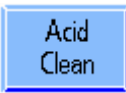

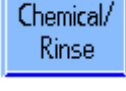
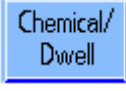
Warning! Any machine filled with a chemical for cleaning or disinfection must be clearly labeled by the operator. The label should identify the chemical used and state that the rinsing and testing for residual chemical are required before using the machine for treatment.

Table 34 – Cleaning and Disinfection Recommended Frequency

Procedure	Frequency	Description
 Page 188	Per Unit Protocol	The Rinse program flushes the hydraulic system with water. A rinse may be done between treatments and must be performed after a Chemical/Dwell procedure to eliminate residual disinfectant.
 Page 184	After Every Treatment	The exterior surface of the machine should be wiped down using a cloth and a disinfecting cleaner. Bloodlines and transducer protectors should be removed and disposed of in compliance with your unit's biohazard waste guidelines. If there is evidence of contamination beyond the external transducer protector, disinfect the transducer, pressure ports, internal tubing and valve and replace the internal transducer protectors.
 Page 189	Daily	The Acid Clean button runs a program that flushes the machine with white distilled vinegar (5% acetic acid) or 2-5% citric acid for 10-60 minutes to prevent the build up of bicarbonate precipitate in the hydraulic system after a treatment. It is <u>not</u> a disinfecting procedure.
 Page 190	Daily	The Heat Disinfect button starts a program that disinfects the hydraulic system using water heated to about 80 °C. Heat Disinfect or Chemical/Rinse is recommended daily when the machine is used for treatment.
 Page 191	Weekly	The Chemical / Rinse button runs a program that disinfects the hydraulic system using a chemical disinfectant followed by an immediate water rinse to clear the system of residual disinfectant. The Chemical / Rinse program should be used when disinfecting with corrosive chemicals, such as bleach, that could damage the hydraulic components if left in contact for prolonged periods.
 Page 193	Per Unit Protocol	The Chemical / Dwell program is designed for long-term disinfection of the hydraulic system using a non-corrosive chemical disinfectant, such as formaldehyde. This program is intended for use with chemicals that are not harmful to the internal components after prolonged exposure.
 Page 194	Daily	The Acid & Heat Disin button (functional software version 2.38 or later) runs the Acid Clean program (see previous page) followed by the Heat Disinfection program (see previous page). The entire Acid & Heat Disin program must be run in order to both clean and disinfect the machine. This program is recommended daily on the days the machine is used for treatment.
 Page 186	Weekly	Disinfect bicarbonate concentrate containers and suction caps per facility protocol.
 Page 186	Daily	Rinse and air dry all bicarbonate concentrate containers and suction caps.

Additional Disinfection Requirements

In addition to the routine cleaning and disinfection tasks listed in the previous table, additional disinfection is required for the following situations:

- Each time the water treatment system is disinfected

When the water treatment system and distribution piping are disinfected, each dialysate delivery machine should be placed in the Rinse program to draw disinfectant into the machine through the inlet lines. Check for residual disinfectant prior to use for dialysis.
- After contamination of a transducer protector

Disinfect the connectors and replace the internal transducer protector if there is evidence of leakage past the external transducer protector on the venous or blood pump modules. Disinfect the transducer, pressure ports, internal tubing and valve.
- After a dialyzer blood leak

The machine should be disinfected prior to the next treatment if a blood leak alarm occurred.



Warning! The protocol for disinfection is determined by the facility and its medical director. When chemicals are used internally, machines must be thoroughly rinsed and tested for residual disinfectant before using the machine for treatment. Follow the instructions of the chemical manufacturer for residual testing.

If procedures other than the manufacturer's are used, it is the responsibility of the medical director to validate the disinfection procedure for efficacy and safety. Failure to follow the disinfection instructions given in this manual could result in patient infections and cross-contamination. Hazards that may result from use of other procedures include patient exposure to hazardous chemicals or infectious agents.

Warning! It is the responsibility of the clinic to disinfect and maintain the hygienic quality of any central delivery systems to which the 2008T hemodialysis machine may be connected.



Note: The manufacturer recommends daily heat disinfection, but if the clinic's policy requires chemical disinfection daily, then heat disinfection should be run weekly.

Cleaning the Exterior Surface

The exterior of the dialysis machine should be cleaned after every treatment. It can be cleaned with very dilute (1:100) bleach or other suitable hospital disinfectant. Use surface cleaning agents sparingly to avoid excess cleaner from entering the interior of the machine, and do not use them at all on the back panel (see Figure 10). Rinse off cleaning solution with a water-dampened cloth, especially if a corrosive, cleaning agent such as bleach is used.

Freshly prepared dilute bleach solution (1:100) is currently recommended by the Center for Disease Control as a suitable disinfectant for the Hepatitis virus. Because surface contamination is the general mode of transmission for this type of virus, thorough cleaning of the 2008T hemodialysis machine exterior is essential.

70% isopropyl alcohol is an acceptable cleaning option for the touchscreen of all 2008T machines (2008T BlueStar and 2008T). It may also be used on the rest of the surface of 2008T BlueStar machines. These can be identified by the part number stamped on the interior of the cabinet; 2008T machines (including those upgraded to 2008T BlueStar in the field) have only a date stamp and no part number. Isopropyl alcohol is not recommended for surface cleaning of 2008T machines (except the touchscreen). Ask a qualified service technician to remove the far left module from the front of the machine (where the Arterial Drip Chamber normally goes—see Figure 1) in order to identify which type of machine it is. The part number is stamped on the left interior wall of the cabinet.



Caution: Do not use foaming type cleansers or disinfectants containing quaternary ammonium compounds like N-alkyl ($C_{12} - C_{18}$) dimethyl benzyl ammonium chloride. These cleansers have multiple names which may include mixed dialkyl (C_8-C_{10}) dimethyl ammonium chloride, dialkyl dimethyl ammonium chlorides, quaternary ammonium compounds, di- C_8-C_{10} -alkyldimethyl, and dicapryl/dicaprylyl dimonium chloride. These ingredients attack the polycarbonate plastics used in the machine. Read the cleaning product labels and follow the instructions.



Note: The use of isopropyl alcohol is not recommended for surface cleaning of the BTM, BVM or Single Needle modules.

Removing the Blood Pump Rotor

If a blood leak occurs inside the blood pump module, make sure to clean around the blood pump rotor. Remove the rotor during cleaning. To remove the rotor:

1. Open the blood pump door.
2. Grasp the crank lever (Figure 90 Step 1) and pull it out until it stops.
3. Use the lever to rotate the rotor a quarter turn in either direction (Step 2).
4. Still holding the lever, pull the rotor off.

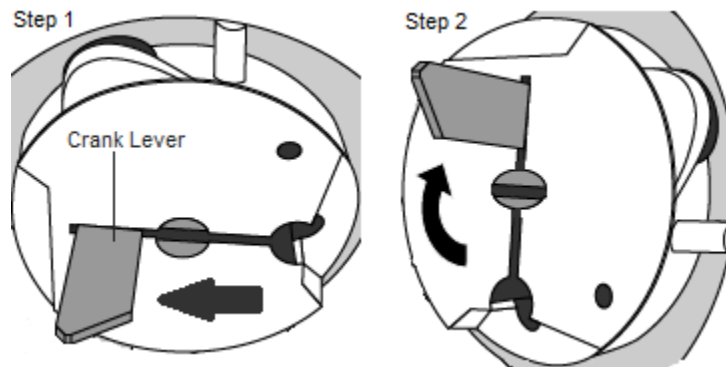

Figure 90 – Blood Pump Rotor Removal



Warning! Inspect the blood pump rotor for proper operation (tubing guide posts not bent, rollers move freely, crank lever moves freely). Bent or loose tubing guide posts can damage bloodlines. Replace rotor if necessary.

The bibag Connector

The optional bibag connector is connected to the 2008T hemodialysis machine's hydraulics so running rinse or cleansing/disinfection programs from the "Select Program" screen will also rinse or disinfect the bibag connector.

To prevent bicarbonate buildup on the bibag connector:

- Clean the exterior of the sealing area of the bibag nozzles with very dilute 1:100 bleach every day before running a rinse or cleansing/disinfection program.
- Run an Acid Clean program at the end of every treatment day before running a Heat Disinfect program.



Warning! A rinse or cleansing/disinfection program must be run after cleaning the sealing area of the bibag nozzles on the bibag connector to rinse away residual disinfectant.

Warning! Do not open the bibag door during a Heat Disinfection, as serious injury may occur. Keep the bibag door closed when running any rinse or disinfection program.

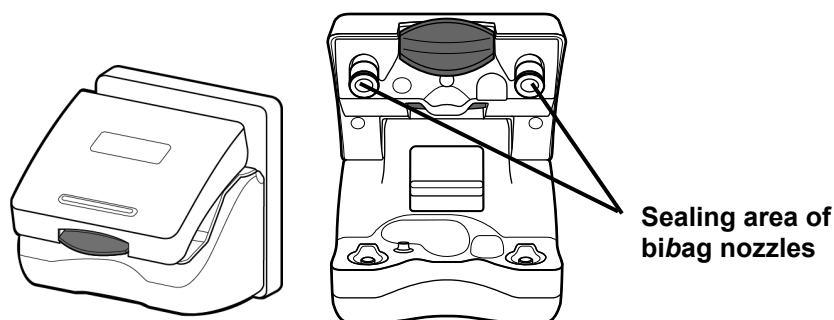

Figure 91 – The bibag Connector Closed and Open

Concentrate Containers

Bicarbonate Concentrate Containers: Clean the containers and suction caps daily. To clean, add 1 gallon of treated water to the container and tighten the cap. Invert and shake the container to wet the entire interior. Empty the containers (shake if necessary), and leave them empty and inverted when stored overnight.

Disinfect the containers and suction caps once per week. Prepare a solution of bleach in treated water at a proportion of 1:100. Add 1 gallon of the bleach solution to the container and tighten the cap. Invert and shake the container to wet the entire interior. Allow the bleach solution to remain in the container for 10 minutes and then rinse the containers and caps thoroughly with treated water. Check for residual disinfectant before using the disinfected containers and caps. Leave all containers empty (shake if necessary) and inverted when stored overnight.

Acid Concentrate Containers: Although not required, if cleaning or disinfection of containers and suction caps is desired, use the following methods. To clean, add 1 gallon of treated water to the container and tighten the cap. Invert and shake the container to wet the

entire interior. Empty the containers (shake if necessary), and leave them empty and inverted when stored overnight. To disinfect, prepare a solution of bleach in treated water at a proportion of 1:100. Add 1 gallon of the bleach solution to the container and tighten the cap. Invert and shake the container to wet the entire interior. Allow the bleach solution to remain in the container for 10 minutes and then rinse the containers and caps thoroughly with treated water. Check for residual disinfectant before using the disinfected containers and caps. Leave all containers empty (shake if necessary) and inverted when stored overnight.

Cleaning the Blood Pressure Cuff

The blood pressure cuff should be disinfected after each patient use. It may be disinfected with commercially available disinfectants. Some disinfectants may cause skin irritation. Rinse thoroughly to remove any residual disinfectant. Follow the disinfectant manufacturer's instructions.

If the cuff is torn such that it does not fit snugly on the patient's arm, it should be replaced.



Caution: If a chlorine bleach solution is used to disinfect the blood pressure cuff, the service life of the cuff may be reduced. Do not autoclave the cuff.

Water Supply Maintenance

It is recommended that the bacterial quality of both the water and the dialysate be checked on a routine basis. These checks should take place just before routine disinfection of the system. Follow the manufacturer's instructions for the operation and storage of reverse-osmosis (RO) and water pre-treatment equipment.

All sections of the treated water feed system and dialysate delivery machine must be disinfected regularly to minimize bacterial levels. Each time the treated water system and distribution piping are disinfected, the dialysis machines should be put into the Rinse program. This allows the disinfectant chemical to feed through the inlet system. Test the water for residual disinfectant prior to use for dialysis.



Warning! The selection and maintenance of water pre-treatment equipment for dialysis is the responsibility of the clinic—the water quality should be periodically tested according to clinic policy. For clinics adhering to the RD52 standard, water for dialysis must have less than 200 CFU/mL for microbial count and less than 2 EU/mL for endotoxin measurement. For clinics adhering to the ISO 26722 standard, water for dialysis must have less than 100 CFU/mL for microbial count and less than 0.25 EU/mL for endotoxin measurement. The failure to provide water of adequate quality for dialysis may result in patient injury or death.



Note: The water inlet line is part of the water distribution system and is not disinfected by the dialysis machine. With some RO systems, the water inlet line may be disinfected along with the RO and distribution piping by leaving the dialysis machine in Rinse mode during RO disinfection.

Rinse Program

The Rinse program may be run before each treatment and must be run after performing a chemical disinfection. The length of the rinse cycle is determined through an internal setting, and can be set to run for 10 to 60 minutes. The Rinse program is run with the dialysate supply lines on the shunt and the concentrate connectors inserted in their respective ports. The program performs a complete rinsing of the dialysate circuit and concentrate suction lines.

If the machine has been idle for more than 48 hours after being rinsed, we recommend a disinfection cycle prior to use.

To run the Rinse program:

1. Ensure that both dialysate lines are on the shunt, and both concentrate connectors are in their respective ports.
2. From the “Select Program” screen, select the **Rinse** button. The “Rinse” screen will be displayed (see Figure 92). The progress of the rinsing is indicated by the horizontal bar.
3. At the end of the Rinse program, the machine will display the message, “Press CONFIRM to exit.” Press **CONFIRM** to exit when the Rinse program has been completed.

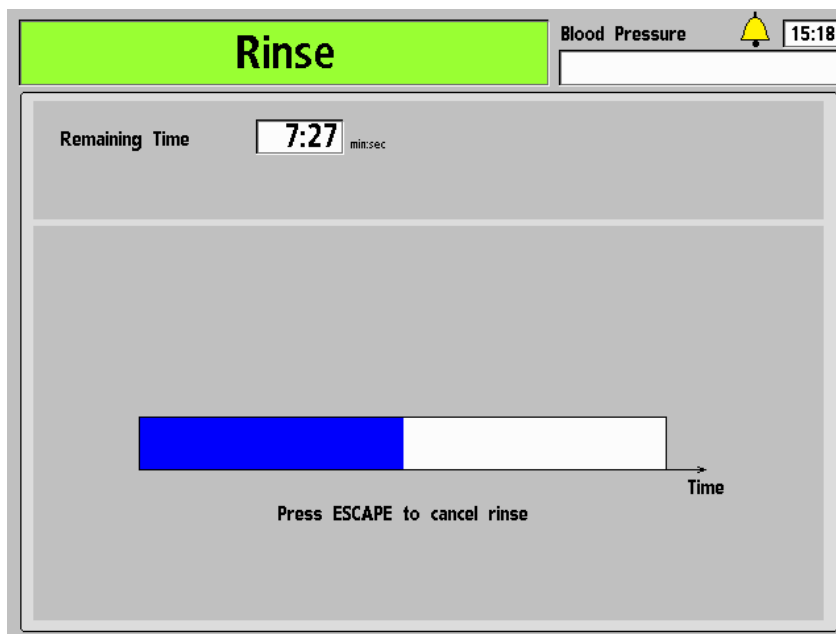

Figure 92 – The Rinse Screen



Note: If the rinse cycle followed chemical disinfection, the water from the rear drain must be tested to ensure that residual disinfectant has been reduced to an acceptable level.

Acid Clean Program

The 2008T hemodialysis machine should undergo an acid cleaning daily when using bicarbonate concentrates during dialysis. The purpose of the Acid Clean program is to prevent the buildup of bicarbonates inside the machine that can have a detrimental effect on the machine's performance and treatment efficacy. **The Acid Clean program is not a method of disinfection.**

Acid Cleaning can be accomplished using 2-5% citric acid or 5% acetic acid (white distilled vinegar).

To run the Acid Clean program:

1. Attach a sign to the front of the machine that identifies the chemical being used to acid clean the machine.
2. Ensure that both dialysate lines are on the shunt, and both concentrate connectors are in their respective ports.
3. From the “Select Program” screen, select the **Acid Clean** button. The Message “Wait: Rinsing Line” appears.
4. Attach the acid and bicarbonate connectors to a jug (s) containing an acid cleaner when prompted.
5. Press **CONFIRM** to start the Acid Clean program. The “Acid Clean” screen appears in the display (see Figure 93). The progress of the acid cleaning is indicated by the horizontal bar.
6. Return connectors to their ports when prompted.
7. When prompted, press **CONFIRM** to exit.

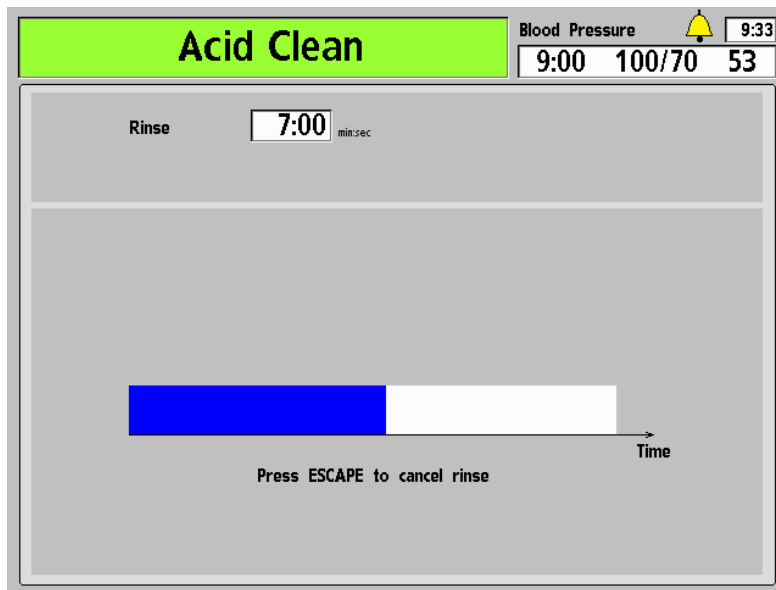

Figure 93 – The Acid Clean Screen

Heat Disinfection Program

The Heat Disinfect program disinfects the machine by running hot water (about 176 °F/80 °C) through the machine. The water recirculates at a program-controlled flow of about 400 ml/min. The program time can be set internally to run between 10 and 60 minutes. Refer to ANSI/AAMI 11663:2014 in order to determine appropriate heat and chemical disinfection cycle parameters. The timer starts as soon as the temperature of the water reaches 176 °F/80 °C.

To run the Heat Disinfect program:

1. Ensure that both dialysate lines are on the shunt, and both concentrate connectors are in their respective ports.
2. From the “Select Program” screen, select the **Heat Disinfect** button. The “Heat Disinfect” screen appears in the display (see Figure 94). If the machine was not rinsed prior to this, it will automatically run a short rinse (ten minutes) or an extended rinse (20 minutes) depending on how the machine was configured in Service Mode.

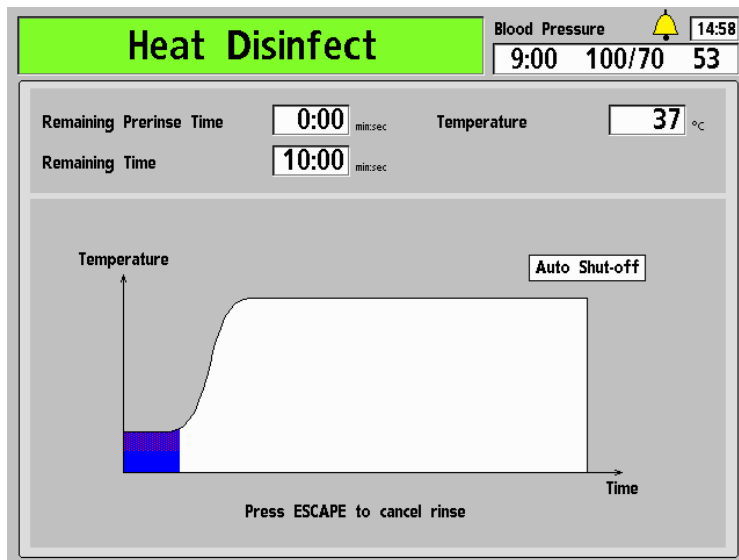

Figure 94 – The Heat Disinfection Screen



Warning! During the heat disinfection cycle, it is not uncommon to see steam emitting from the vent tubing at the back of the machine. This steam may cause burns if contacted. Also, the temperature of the dialysate lines may exceed 176 °F/80 °C and the temperature of the drain line may exceed 156 °F/69 °C. Please use care.

Warning! Do not open the bibag door during a Heat Disinfection, as serious injury may occur. Keep the bibag door closed when running any rinse or disinfection program.

3. After the heat disinfection is complete, if the machine is not configured to automatically turn off at the completion of the cycle, press **CONFIRM** to exit when prompted.



Note: The drain line is subjected to a lower temperature and shorter heat cycle than the rest of the machine. If desired, use the “Extended Pre-rinse” option in Service Mode to control build-up of biological material in the drain line.

Note: Cooling time can be shortened by running the Rinse program, which will flush the machine with 98.6 °F/37 °C water. Do not cool the machine with the Rinse program unless the machine will be used immediately afterwards.

Chemical/Rinse Program

The Chemical/Rinse program should be used when disinfecting the hydraulic system with corrosive chemicals, such as bleach. The Chemical/Rinse program consists of a disinfection cycle followed by a water rinse cycle.



Caution: To avoid internal damage these chemicals should not remain in contact with the machine. Rinse your machine immediately after completing the disinfection.

To run the Chemical/Rinse program:

1. Attach a sign to the front of the machine that identifies the chemical being used to disinfect the machine.
2. Ensure that both dialysate lines are on the shunt, and both concentrate connectors are in their respective ports.
3. From the “Select Program” screen, select the **Chemical/Rinse** button.
4. The “Chemical/Rinse” screen appears in the display (see Figure 95). The progress of the disinfection program is indicated by the horizontal bar. The program starts with a 45 second pre-rinse. The message, “Rinsing Lines, Please Wait” is displayed in the Status Box.



Note: If the ‘HE Leak Test’ Service Mode option is selected (functional software versions 2.53 and later), the machine will run a four minute pressure holding test after the 45 second pre-rinse. If the first test fails, a second test will automatically run.

If the second test fails, the machine will display a “System Leak, Can’t Run” message, meaning that the Chemical/Rinse program can no longer be run due to a leak detected in the Heat Exchanger. However, the machine will still be able to run Heat Disinfection programs and hemodialysis treatments per unit protocol. Call a qualified service technician.

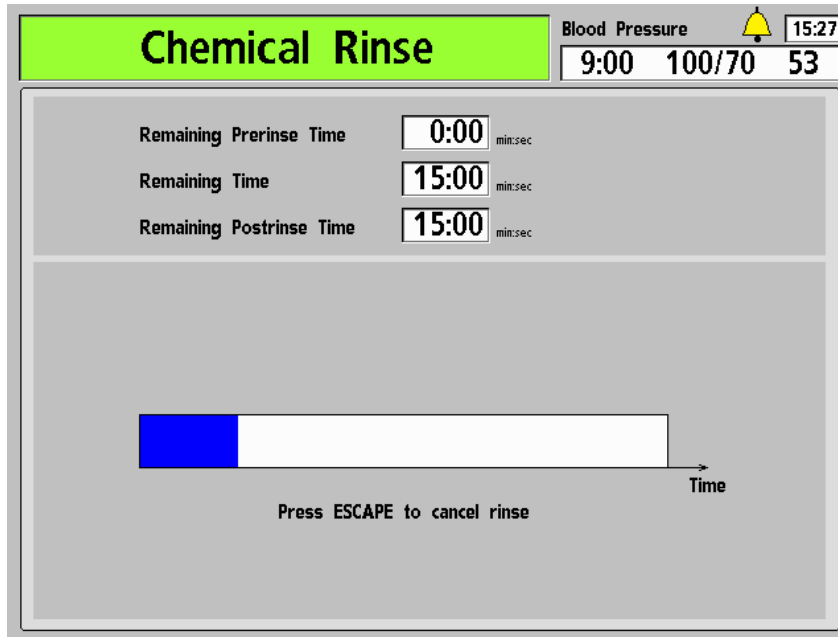

Figure 95 – The Chemical Rinse Screen

5. Connect the red connector to a jug containing the chemical disinfectant and press **CONFIRM** when prompted.
6. A water pre-rinse will start and the Remaining Pre-rinse Time meter box will count down.
7. When Remaining Pre-rinse Time meter box reaches 0:00, the chemical rinse will start after a delay. The Remaining Time meter box will then count down.



Note: Visually confirm that disinfectant has been pulled into the machine.

8. When the Remaining Time meter box reaches: 0:00, remove the red acid connector from the disinfectant jug and insert it into the acid rinse port when prompted. A Postrinse will start and the Remaining Postrinse Time meter box will count down.
9. When prompted, press **CONFIRM** to exit.



Warning! Test for residual disinfectant prior to starting treatment following a chemical disinfection.



Note: The machine will automatically perform a Diasafe test after the Chemical Rinse program ends.

Chemical/Dwell Program

The Chemical/Dwell program should be used when disinfecting the hydraulic system using chemical disinfectants that can remain in contact with internal components for prolonged periods without damaging them. Formaldehyde can be used with the Chemical/Dwell program for maximum effectiveness.

To run the Chemical/Dwell program:

1. Attach a sign to the front of the machine that identifies the chemical being used to disinfect the machine.
2. Ensure that both dialysate lines are on the shunt, and both concentrate connectors are in their respective ports.
3. Place the concentrated disinfectant in the small container with the yellow cap.
4. From the “Select Program” screen, select the **Chemical/Dwell** button.

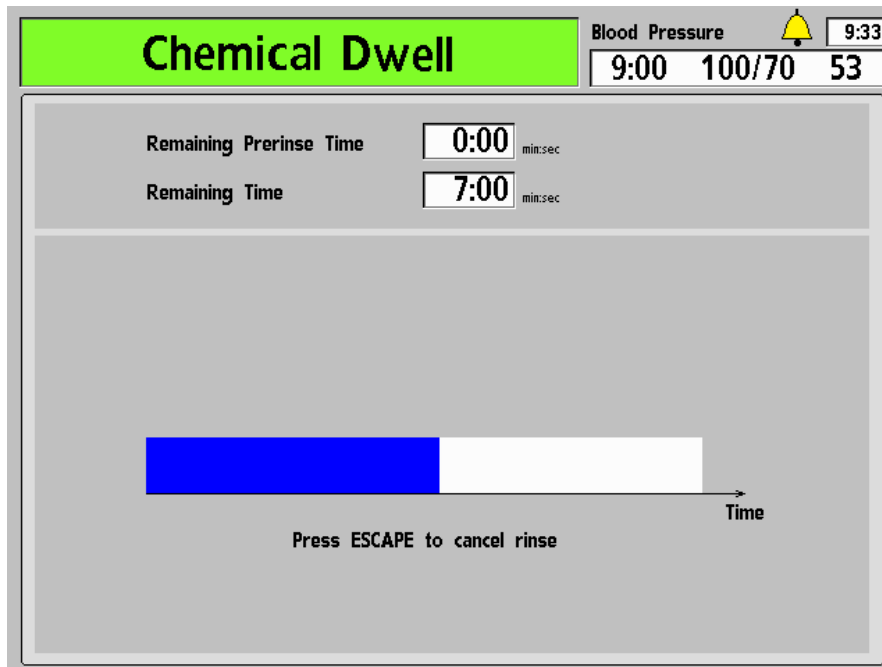

Figure 96 – The Chemical/Dwell Screen

5. The “Chemical/Dwell” screen appears in the display (see Figure 96). The progress of the disinfection program is indicated by the horizontal bar. The program starts with a 45 second rinse. The message, “Rinsing Line, Please Wait” is displayed in the Status Box.
6. When prompted, connect the red connector to a chemical disinfectant. Press **CONFIRM**.

7. The water Pre-rinse will start and the Remaining Prerinse Time meter box will count down.
8. The Chemical Dwell will follow after a delay. The Remaining Time meter box will count down.
9. When the Remaining Time meter box reaches 0:00, remove the red acid connector from the disinfectant jug and insert it into the acid rinse port. The machine will automatically run for about a minute to draw up the disinfectant left in the tubing.



Note: Visually confirm that disinfectant has been pulled into the machine.

10. Following the completion of the chemical disinfection cycle, “Press CONFIRM to exit” will be displayed in the Status Box. Press **CONFIRM** to exit.



Warning! The mandatory rinse cycle must be completed and a test for residual disinfectant must be performed prior to the next treatment.

Acid & Heat Disin (Disinfect) Program

The 2008T hemodialysis machine should undergo an acid cleaning daily when using bicarbonate concentrates during dialysis in addition to daily disinfection on treatment days. The purpose of the Acid & Heat Disin program (functional software version 2.38 or later) is to prevent the buildup of bicarbonates inside the machine that can have a detrimental effect on the machine’s performance and treatment efficacy and to then disinfect the machine. **The entire Acid & Heat Disin program must be run in order to both clean and disinfect the machine.**

Acid Cleaning can be done using 2-5% citric acid or 5% acetic acid (white distilled vinegar).

The Heat Disinfect program disinfects the machine by running hot water (about 176 °F/80 °C) through the machine. The water circulates at a program-controlled flow of about 400 ml/min.

To run the Acid & Heat Disin program:

1. Attach a sign to the front of the machine that identifies the chemical being used to acid clean the machine.
2. Ensure that both dialysate lines are on the shunt, and both concentrate connectors are in their respective ports.
3. From the “Select Program” screen, select the **Acid & Heat Disin** button. The Message “Wait: Rinsing Line” appears.
4. Connect the acid and bicarbonate connectors to a jug(s) containing an acid cleaner when prompted.

5. Press **CONFIRM** to start the Acid Clean portion of the program. The “Acid Clean” screen appears in the display (see Figure 93 – The Acid Clean Screen). The progress of the acid cleaning is indicated by the horizontal bar.
6. Return connectors to their ports when prompted (the machine will beep every 30 seconds until the connectors are inserted back in the rinse ports). The “Heat Disinfect” screen appears next in the display (see Figure 94 – The Heat Disinfection Screen). The machine will automatically run a short rinse (ten minutes) or an extended rinse (20 minutes) depending on how the machine was configured in Service Mode. The Heat Disinfect starts as soon as the temperature of the water reaches 176 °F/80° C. The program time can be set internally to run between 10 and 60 minutes.



Warning! During the heat disinfection cycle, it is not uncommon to see steam emitting from the vent tubing at the back of the machine. This steam may cause burns if contacted. Also, the temperature of the dialysate lines may exceed 176 °F/80 °C and the temperature of the drain line may exceed 156 °F/69 °C. Please use care.

Warning! Do not open the bibag door during a Heat Disinfection, as serious injury may occur. Keep the bibag door closed when running any rinse or disinfection program.

7. After the heat disinfection is complete, if the machine is not configured to automatically turn off at the completion of the cycle, press **CONFIRM** to exit when prompted.



Note: The drain line is subjected to a lower temperature and shorter heat cycle than the rest of the machine. If desired, select the “Extended Pre-rinse” option in Service Mode to control build-up of biological material in the drain line.

Note: Cooling time can be shortened by running the Rinse program, which will flush the machine with 98.6 °F/37 °C water. Do not cool the machine with the Rinse program unless the machine will be used immediately afterwards.

Testing for Disinfectant

After a chemical disinfection cycle, the machine must be checked for residual disinfectant before initiating dialysis. A sample for testing for residual disinfectant can be obtained from a dialysate line or the drain line.

Table 35 – Disinfectant Detection Methods

Disinfectant	Detection Method
Formaldehyde	Using Schiff's reagent or a commercially available formaldehyde test, measure the residual formaldehyde according to the manufacturer's directions. The level of formaldehyde should be less than 5 ppm.
Bleach	Use facility protocol for detecting chlorine levels in the fluid sample.
Renalin 100	Test according to the manufacturer's instructions using a residual test intended for this product.
Diacide HD	Test according to the manufacturer's instructions using Nephrect or another test intended for this product.

Power Failure During Chemical Disinfection

If a Chemical/Rinse or Chemical/Dwell program is interrupted, the machine will only allow Rinse, Chemical/Rinse, or Chemical/Dwell to be selected from the “Select Program” Screen when power is restored. A message “Mandatory Rinse” will be displayed after the **Rinse** button is selected.

If a mandatory rinse cycle is interrupted by a power failure, only a Rinse program is available in the “Select Program” screen. The entire Rinse program must be completed before the operator can initiate dialysis.



In the event of a power failure, the Chemical/Rinse or Chemical/Dwell program will not be recorded in the disinfection log or last disinfection field on the “Select Program” screen until the program is completed.

Power Failure During Heat Disinfection

In the event of a power failure, the Heat Disinfection program will not be recorded in the disinfection log or last disinfection field on the “Select Program” screen until the program is completed.

Disinfect Log (Optional)

The 2008T BlueStar Premium “Disinfection Log” screen (see Figure 97 below) is available by selecting the **Disinfect Log** screen-button on the “Select Program” screen (see Figure 89). The user may then use the **↑** or **↓** (up or down) keys on the keyboard to scroll through the last 1,200 heat or chemical/rinse disinfection events stored on the machine.

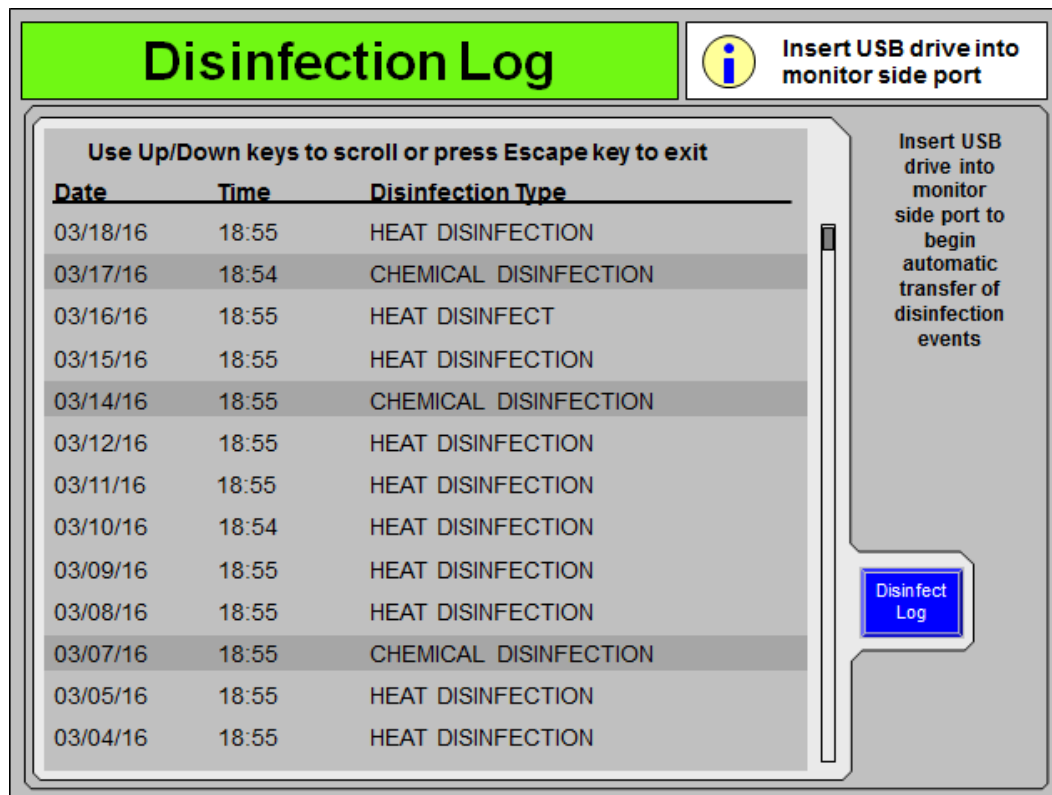

Figure 97 – The Disinfect Log Screen

To save the last 1,200 disinfection events stored on the machine to a USB drive, insert a USB drive into USB Port 1 on the right side of the 2008T hemodialysis machine display monitor. The 2008T hemodialysis machine will immediately begin transferring the data while displaying the transfer progress in a bar graph. Do not remove the USB drive until the transfer is complete (at 100%).



Note: The USB drive used to save the disinfection log must be less than 4GB and formatted to the FAT32 file system.

Alarms and Troubleshooting

This chapter covers atypical situations such as alarm events that can occur during treatment. At the end of this chapter are also procedures for testing the DIASAFE *plus*_{US} Filter and replacing the power failure alarm battery.

Operational Status

The 2008T hemodialysis machine is equipped with a system of electronic components and diagnostic software that monitor its operation and performance. When problems or potential problems are detected, the operator is alerted through informational messages displayed on the screen and in some cases, audible alarms. Audible alarms are suppressed however, when the dialysate supply lines are on the shunt, providing no blood is sensed.

The informational messages are displayed in two places in each treatment screen: the Status Box and the Dialogue Box. The Status Box is present in every screen. The Dialogue Box appears in place of the Time and Blood Pressure displays in situations requiring input from the operator.



Note: Starting in functional software version 2.72: to adjust the volume of the audible alarm, select the **Bell** button and use the **+** (plus) or **-** (minus) buttons. For more information, see the Dialogue Box description on page 31.

The Status Box is a rectangular box found in the upper left corner of every screen (see Figure 98). The message in it describes the current mode of the machine or a problem during treatment. There are three operational conditions or statuses: Normal, Low Alarm, and High Alarm. The background color of the Status Box changes color to accentuate the operational status.



Warning! All alarms need your immediate attention. Failure to do so may cause serious injury or death.



Note: If the machine is displaying CDX when an alarm occurs, the machine will automatically switch back to Dialysis/SLED. See Appendix C on page 297 for more information on CDX.

Note: Alarm lights and sounds can be set to either the default 'Standard' setting or the 'Acute' setting, see page 340 for more information.

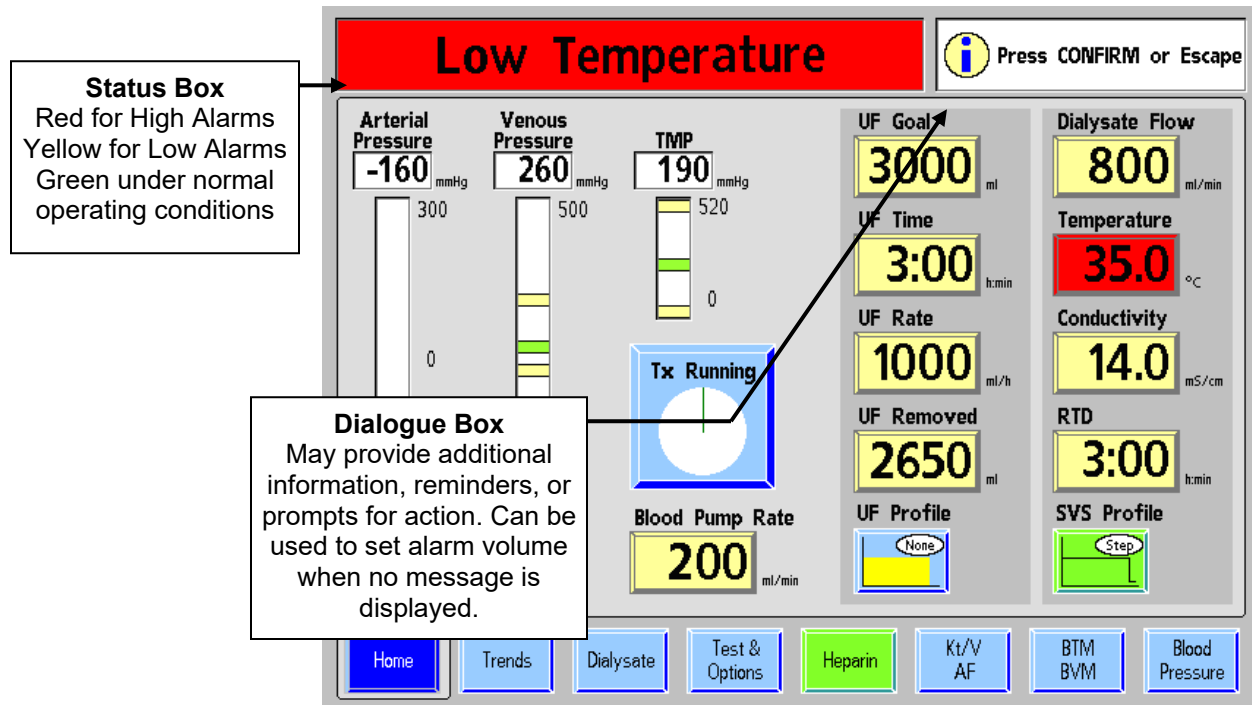

Figure 98 – Status Box and Dialogue Box during an Alarm Event

The Dialogue Box, found in the upper right corner of the display screens, can provide information on the patient, prompt an action, or serve as a reminder. The Dialogue Box can appear alone or supplement the message displayed in the Status Box during a Low Alarm condition. In some cases, Dialogue Boxes, if ignored for a prolonged period, can trigger a Low Alarm message in the Status Box. Although a Dialogue Box can appear during an alarm event, the messages displayed in each may represent two separate, unrelated issues.

Normal Status

The Status Box displays a green background under normal operation when no problems have been detected. During dialysis operation, the Status Box will display a message describing the current mode of the machine—Dialysis or SLED. When a Dialogue Box message is not displayed, the Dialogue Box displays the current time, patient blood pressure and pulse and the time taken.

Low Alarm Status

The Status Box background changes to yellow when a Low Alarm condition exists. A Low Alarm condition, although potentially serious, does not pose an immediate threat to the patient. Low Alarm events do not stop the blood pump. The message displayed in the Status Box is intended to alert the operator of a functional anomaly, a procedural error, or an existing condition requiring remedial action. A Low Alarm may be accompanied by an audible alarm.

High Alarm Status

High Alarm situations require the immediate attention of the operator. Under these circumstances, the background of the Status Box turns bright red. An audible alarm also accompanies these High Alarm events.

There are three types of High Alarm events:

- Blood Alarms
- Water/Dialysate Alarms
- Other



Note: The 2008T hemodialysis machine may be configured to suppress all audible alarms until blood is sensed in the venous line by the optical sensor below the venous clamp assembly. In these machines, the audible alarms occur only if the dialysate lines are off the shunt and blood is sensed by the optical detector. This option is activated internally by a qualified technician, and is the prerogative of the Medical Director. Otherwise, alarms are always audible once the dialysate lines are off the shunt.

Note: CDX is unavailable during an alarm when blood is sensed and the Tx Clock is running.

Blood Alarms

Blood alarm events have the highest priority. When a blood alarm occurs:

- The blood pump stops
- The venous clamp on the level detector occludes
- The UF pump stops
- RTD stops

The control panel is used to mute, reset, and override a blood alarm. Figure 99 – Control Panel Features for Blood Alarms identifies the location of the keys used during a blood alarm. The accompanying table describes the function of each feature.

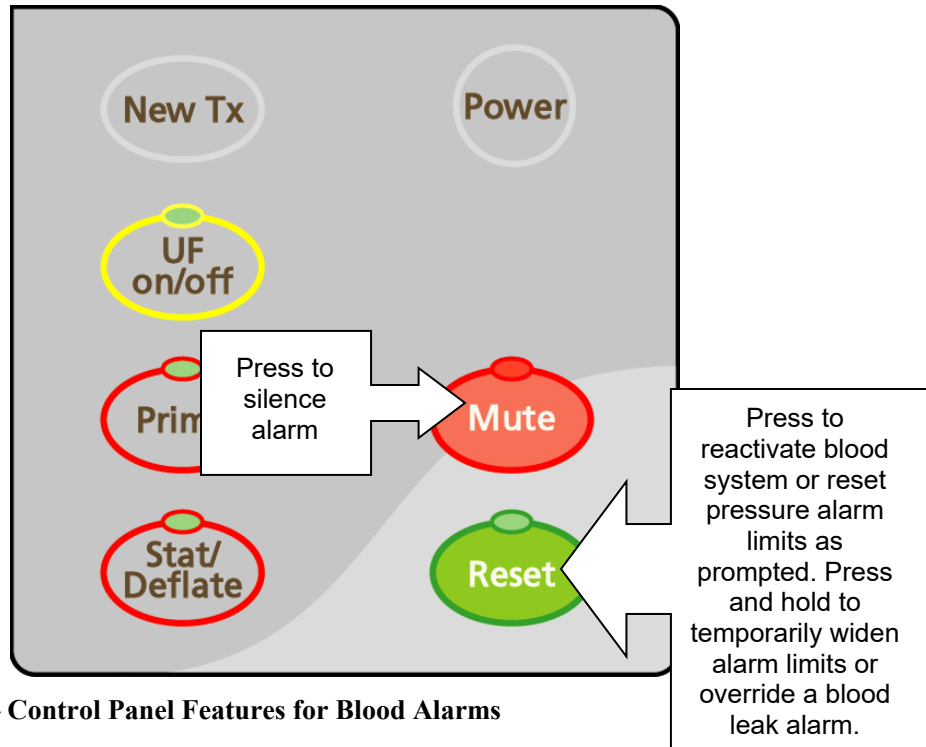





Figure 99 – Control Panel Features for Blood Alarms

Table 36 – The Control Panel Keys Used During Alarms

Press...	To...
	<p>Silence an alarm for two minutes or until another alarm event occurs. The red Mute light illuminates.</p> <p>Functional software version 2.72 or later: A muted alarm is also indicated in the Dialogue Box with a red X on a Bell, see page 31 for more information.</p>
	<p>Press to reset the machine after an alarm.</p> <p>Press and hold for two seconds to spread the alarm window by 300 mmHg for arterial and venous pressures and fully open the transmembrane (TMP) pressure window for 30 seconds. The light above the Reset key will not be on.</p> <p>During a blood leak alarm, press and hold for three seconds to override the alarm and keep the blood pump running for three minutes. The light above the Reset key will be on during an override.</p>
	Warning! During an override, the machine's blood leak detector is inactive. You must monitor the treatment.
	Note: The Reset key light flashes when a blood alarm occurs.

Water/Dialysate Alarms

During a water/dialysate alarm (temperature or conductivity), the blood system continues to operate, but the dialysate fluid is internally bypassed around the dialyzer. This can be verified by visually inspecting the flow meter in the dialysate supply line. During bypass, the float will remain stationary at the bottom of the sight glass.

A flow alarm will not cause the machine to go into bypass. Water/dialysate alarms are self-resetting when the alarm condition is corrected. Temperature and conductivity alarms do not occur during the Isolated UF mode of Sequential dialysis when there is no dialysate flow.

Other Alarms

Other alarms may be associated with other components, such as the Heparin or UF pumps, BPM, BVM, BTM, etc.

Troubleshooting

All status messages (operational alarms, dialogues, and advisories) are displayed on the control panel screen. These messages are generated due to conditions and events that occur in the machine during operation. These messages will reset when the condition causing the message is corrected. In some cases, the operator must reset them.

The table following this section is indexed by Status Box message. The table consists of four columns:

- Status Box Message
- Message Purpose
- Message Type
- Action Required

Status Box Message

The Status Box Message column identifies the message as it appears in the Status Box or in the Dialogue Box of the display screen.

Purpose of Message

The Purpose of Message column is a brief explanation of the Status Box message or the condition that generated it.

Type

The Type column identifies the message as an alarm, a dialog, or an advisory. A High Alarm message requires immediate attention. It is accompanied by a visual indicator and an audible alarm sound. A Low Alarm message notifies the user of an existing condition. It could be accompanied by an audible alarm. An advisory message prompts the operator to take a specific action in a procedure or informs the operator that a particular machine operation is in progress. Many advisories require no action on the part of the operator.

Action Required

The Action Required column provides recommended actions in response to a given Status Box message. In addition, your unit might require other patient-specific treatment actions that are not listed here. It is each care unit's responsibility to ensure that their operators are made aware of the unit's protocol in these matters.

If performing the recommended action does not clear the Status Box message displayed, treatment should be discontinued until the conditions causing the message are corrected and the message cleared. In rare cases, it may be necessary to turn the machine off and back on to clear an error condition. If problems persist, the machine should be referred to a qualified technician for inspection.



Warning! Performing the recommended action may or may not clear the alarm or advisory messages displayed. Patient treatment shall not proceed until the conditions causing these messages are corrected and the messages cleared. If a machine must be taken out of service, the operator should return the blood to the patient if possible and disconnect the patient from the machine. Follow unit protocol to rinse back the blood using the blood pump or see “Manually Operating the Blood Pump” on page 168 for more information.



Note: Recommendations to take a machine out of service refer to assuring that the machine is not used for patient treatment until conditions causing alarms are resolved. Specific operator action in these cases is to refer the machine, and its associated problems, to a qualified local technician for inspection, testing, and troubleshooting.

Note: There are alarm messages that may be similar. Please take care that you read appropriate message to determine the “Action required” for troubleshooting.

Note: The on-screen cursor will disappear if not moved for five seconds. Simply touch the touchpad to display the cursor again when needed. It also disappears when a value is entered but not yet confirmed. If necessary, press the **Escape** key to display the cursor again.

Note: If the 2008T hemodialysis machine becomes unresponsive (locks-up or ‘freezes’) or if the display screen unexpectedly turns off and does not turn back on when touching it or pressing the **Reset** key, turn off the machine by pressing and holding the **Power** key for two seconds. Press the **Power** key again to restart the machine.

Message	Purpose of Message	Type	Action Required
# of Tests has been set to min	The operator has attempted to set the number of Online Clearance (OLC) tests lower than allowed.	Dialog Message	The machine has set the number of tests to the lowest value allowed. Verify that the number of OLC tests is acceptable. See page 146 for more information.
5 Minutes Flow Off	Dialysate flow has been off for five minutes.	Low Alarm	Press Reset to silence the alarm. If no dialysate flow is desired, continue without running dialysate flow, see "Isolated Ultrafiltration" on page 101 for more information. If you intend for the flow to be on, set the Dialysate Flow button to the prescribed rate and press the CONFIRM key to resume dialysate flow.
**** 5V High ****	Electronic self-test, power supply limits exceeded.	High Alarm	Turn machine power off and back on. If alarm is not cleared, take the machine out of service and alert a qualified service technician.
**** 5V Low ****	Electronic self-test, power supply limits exceeded.	High Alarm	Turn machine power off and back on. If alarm is not cleared, take the machine out of service and alert a qualified service technician.
10 Fill Pgm in 1 hr	Ten fill programs have occurred during a one-hour period.	Low Alarm	<ol style="list-style-type: none"> 1) Check the dialyzer supply and return lines, especially around the connectors and dialysate filter in the dialyzer return line, for air entering the system and correct the problem. 2) Press Reset to clear the alarm. If unable to reset the alarm, return the blood to the patient, take the machine out of service and replace the machine with another machine. Alert a qualified service technician.
			 Note: Using a conventional dialyzer at a high UF rate can cause frequent Fill programs because of a high TMP. Lowering the UF rate by decreasing the UF Goal may solve the problem. Notify a physician if the UF goal has changed.
12V POWER FAIL	Electronic self-test, power supply limits exceeded.	High Alarm	Turn machine power off and back on. If alarm is not cleared, take the machine out of service and alert a qualified service technician.
**** 24V High ****	Electronic self-test, power supply limits exceeded.	High Alarm	Turn machine power off and back on. If alarm is not cleared, take the machine out of service and alert a qualified service technician.
**** 24V Low ****	Electronic self-test, power supply limits exceeded.	High Alarm	Turn machine power off and back on. If alarm is not cleared, take the machine out of service and alert a qualified service technician.

Message	Purpose of Message	Type	Action Required
60 Minutes Flow Off	Dialysate flow has been off for 60 minutes in the sequential option.	Low Alarm	Press the Reset key to clear the alarm. Isolated UF will continue for the remainder of the prescribed treatment time. To cancel Isolated UF and perform hemodialysis to comply with the prescribed treatment, set dialysate flow to the prescribed rate using the keyboard and press CONFIRM . The machine will go into bypass mode until dialysate temperature and conductivity settings are attained (about two minutes). Dialysate flow must be re-established for a minimum of five minutes before resuming Isolated UF or the alarm will reoccur.
A.11 (Arterial or SN Blood Pump Message)	Pump is not reaching speed at maximum voltage	High Alarm	Press the Reset key to clear. If problem persists, return the blood to the patient if alarm occurs during treatment. Take blood pump module out of service and alert a qualified service technician.
A.13 (Arterial or SN Blood Pump Message)	Pump is turning in the wrong direction	High Alarm	Press the Reset key to clear. Verify pump rotor is turning in a clockwise direction. If not, manually return the blood to the patient if alarm occurs during treatment (see page 168 for instructions). Take blood pump out of service and alert a qualified service technician.
A.16 (Arterial or SN Blood Pump Message)	Key stuck or held in too long	High Alarm	Press the Reset key to clear. Verify when adjusting settings, the operator does not hold the key too long. If problem persists, return the blood to the patient if alarm occurs during the treatment. Take blood pump module out of service and alert a qualified service technician.
A.20 (Arterial or SN Blood Pump Message)	Set speed-read back analog voltage at X348/14 is out of limits	High Alarm	Press the Reset key to clear. If problem persists, return the blood to the patient if alarm occurs during the treatment. Take blood pump module out of service and alert a qualified service technician.
A.21 (Arterial or SN Blood Pump Message)	Actual speed-read back analog voltage at X348/10 is out of limits	High Alarm	Press the Reset key to clear. If problem persists, return the blood to the patient if alarm occurs during the treatment. Take blood pump module out of service and alert a qualified service technician.
A.22 (Arterial or SN Blood Pump Message)	Arterial pressure-read back analog voltage at X348/7 is out of limits SN pressure-read back analog voltage is out of limits	High Alarm	Press the Reset key to clear. If problem persists, return the blood to the patient if alarm occurs during the treatment. Take blood pump module out of service and alert a qualified service technician.
A.24 (Arterial or SN Blood Pump Message)	Optical tachometer not in range	High Alarm	Press the Reset key to clear. If problem persists, return the blood to the patient if alarm occurs during the treatment. Take blood pump module out of service and alert a qualified service technician.

Message	Purpose of Message	Type	Action Required
A.25 (Arterial or SN Blood Pump Message)	Pressure increase when the Level Up key is pressed	High Alarm	Press the Reset key to clear. Possibility that the level adjust pump is connected backward so that the level is lowered instead of raised. Verify that the level in the arterial chamber rises when the adjust key is pressed. If it does not, return the blood to the patient if alarm occurs during a treatment. Take the machine out of service and alert a qualified service technician.
A.26 (Arterial Blood Pump Message)	Pressure was adjusted too much in calibration mode	High Alarm	Press the Reset key if this message occurs in Dialysis Mode, If this alarm occurs during a treatment, return the blood to the patient. Take the blood pump module out of service and alert a qualified service technician.
A.27 (Arterial Blood Pump Message)	Time out when receiving Intel-Hex-line or overflowed received buffer	Alarm	Press the Reset key if this message occurs in Dialysis Mode, If this alarm occurs during a treatment, return the blood to the patient. Take the blood pump module out of service and alert a qualified service technician.
A.28 (Arterial Blood Pump Message)	Error in received Intel-Hex-line	High Alarm	Press the Reset key if this message occurs in Dialysis Mode, If this alarm occurs during a treatment, return the blood to the patient. Take the blood pump module out of service and alert a qualified service technician.
A.29 (Arterial Blood Pump Message)	Pump rotor turning when it should not be	High Alarm	Press the Reset key to clear. If problem persists, manually return the blood to the patient (see page 168 for instructions). Take blood pump module out of service and alert a qualified service technician.
A modified Patient Prescription is selected for this treatment, keep new prescription or discard?	The prescribed treatment on the "Prescription" screen was changed and now the operator must decide whether or not to replace the old prescription saved on the PatientCard with the modified prescription or to cancel changes made to the prescription.	Pop-Up	Press the CONFIRM key to delete old prescription and save the new prescription to the PatientCard. or Press the Escape key to continue without saving the modified prescription. The prescription previously saved on the PatientCard will be retained.
Access Flow complete	This message is an advisory message that the Access Flow test is complete.	Low Alarm	Press CONFIRM to clear the message
Access Flow running	This message is an advisory message that the Access Flow test process is continuing.	Advisory	No action is necessary

Message	Purpose of Message	Type	Action Required
Access Flow Test Scheduled	This message is an advisory message that the Access Flow test process is continuing.	Advisory	No action is necessary
Acetate Selected!	Acetate concentrate has been selected and the blue bicarbonate connector is out of its port.	Low Alarm	Connect blue bicarbonate connector into the blue rinse port. Be sure the concentrate selection is correct.
Acid Press Calib Err	biBag system pressure calibration error.	Advisory	Turn machine power off and back on. If message is not cleared, take the machine out of service and alert a qualified service technician.
Acid Pump Alarm	This is a pump failure alarm.	Low Alarm	A single occurrence is not a problem if the machine automatically resets. If the problem persists for longer than one minute or occurs repeatedly, turn power off and back on. If the alarm is not cleared, return the blood to the patient if alarm occurs during treatment. Take the machine out of service and alert a qualified service technician.
Acid Pump Always EOS	This is a pump failure alarm.	Low Alarm	A single occurrence is not a problem if the machine automatically resets. If the problem persists for longer than one minute or occurs repeatedly, turn power off and back on. If the alarm is not cleared, return the blood to the patient if alarm occurs during treatment. Take the machine out of service and alert a qualified service technician.
Acid Pump No EOS	This is a pump failure alarm.	Low Alarm	A single occurrence is not a problem if the machine automatically resets. If the problem persists for longer than one minute or occurs repeatedly, turn power off and back on. If the alarm is not cleared, return the blood to the patient if alarm occurs during treatment. Take the machine out of service and alert a qualified service technician.
Acid pump volume not calibrated	Acid pump volume calibration has been lost or not set.	High Alarm	Turn machine power off and back on. If alarm is not cleared, take the machine out of service and alert a qualified service technician that Acid pump volume calibration is needed.
Acid Rinse Interrupted	An Acid Clean program was running but was interrupted before it could be completed.	Opening Screen Message	Run a rinse program or resume with the Acid Clean program if desired.
Act Blood Pump Failed	Electronic self-test failure.	High Alarm	Turn machine power off and back on. If alarm is not cleared, return the blood to the patient if the alarm occurs during treatment. Take the machine out of service and alert a qualified service technician.

Message	Purpose of Message	Type	Action Required
Act Board CRC Error	Electronic self-test failure.	High Alarm	Turn machine power off and back on. If alarm is not cleared, return the blood to the patient if the alarm occurs during treatment. Take the machine out of service and alert a qualified service technician.
Act BYP Valve Fail 1	Electronic self-test failure.	High Alarm	Turn machine power off and back on. If alarm is not cleared, return the blood to the patient if the alarm occurs during treatment. Take the machine out of service and alert a qualified service technician.
Act BYP Valve Fail 2	Electronic self-test failure.	High Alarm	Turn machine power off and back on. If alarm is not cleared, return the blood to the patient if the alarm occurs during treatment. Take the machine out of service and alert a qualified service technician.
Active Pressure Regulator Uncalibrated	Pressure regulator not calibrated.	High Alarm	Turn machine power off and back on. If the alarm is not cleared, take the machine out of service and call a qualified service technician.
Actuator BD no Echo	Functional to Actuator board communication problem	High Alarm	Turn machine power off and back on. If the alarm is not cleared, return the blood to the patient if alarm occurs during treatment. Take the machine out of service and alert a qualified service technician.
Adjusting TMP	The operator has chosen to relieve the TMP after a TMP alarm	Advisory	No action necessary.
Air Detector Alarm	The level of blood in the venous drip chamber is too low.	High Alarm (Blood)	<ol style="list-style-type: none"> 1) Inspect the venous drip chamber and level detector module to see if: <ul style="list-style-type: none"> • There is an adequate level of blood (approximately $\frac{3}{4}$ full) in chamber. • The venous drip chamber is properly mounted in its holder. • The venous drip chamber is positioned with the mesh filter below the level detection sensors. • The sensors are clean (if not, clean with an alcohol pad). • The Level Detector door is closed and latched 2) Raise blood level by pressing and holding the ▲ (up) key on the level detector until the chamber is approximately $\frac{3}{4}$ full. 3) Press the Reset key to reset the alarm. If unable to reset alarm, return the blood to the patient and take the machine out of service. Have a qualified service technician recalibrate for the type of bloodline used. <div style="display: flex; align-items: center;">  <p>Warning! Ensure that air will not be infused into the patient when the blood flow is re-established.</p> </div>

Message	Purpose of Message	Type	Action Required
Alarm Test Failed	The Alarm Test section of the Automated Test Sequence has failed.	High Alarm	Press the Reset key once to mute the alarm; pressing it a second time resets the right side of the screen. Retest. If the machine fails on retest, take the machine out of service.
Art. BP no comm.	The blood pump module has lost communication with the machine	High Alarm	Turn machine power Off and back On. If alarm is not cleared, manually return the blood to the patient if the alarm occurs during treatment (see page 168 for instructions). Take the machine out of service and alert a qualified service technician.
Art. Pressure Alarm (with the upper Arterial Pressure Alarm limit flashing)	The pressure inside the arterial drip chamber is above the set alarm limits.	High Alarm (Blood)	<ol style="list-style-type: none"> 1) Check arterial and venous tubing for kinked line, clotting or clamps. 2) Ensure that the transducer protector is dry and the monitor line is open. Replace transducer protector, if necessary. 3) Check for clotted fibers in the dialyzer 4) Check to see if blood flow rate is too high, especially with a post-pump monitor. 5) Press Reset to reset alarm. If applicable, press Reset again and hold for two seconds to select new alarm limits. 6) If unable to reset the alarm, return blood to the patient if possible. Do not return clotted blood to the patient. 7) Take the machine out of service and alert a qualified service technician.

Message	Purpose of Message	Type	Action Required
Art. Pressure Alarm (with the lower Arterial Pressure Alarm limit flashing)	The pressure inside the arterial drip chamber is below the set alarm limits	High Alarm (Blood)	<ol style="list-style-type: none"> 1) Check the arterial tubing for kinks, clotting, or clamps. 2) Check the needle position and access patency. 3) Ensure that the transducer protector is dry and the monitor line is open. Replace transducer protector, if necessary. 4) Check to see if blood flow rate is too high, especially with a pre-pump monitor.
			 <p>Note: Pre-pump arterial monitoring is very sensitive to access problems (e.g., access spasms, needle tip occlusions from patient movement). A slower blood pump rate will bring the pre-pump arterial pressure up. Assess whether the patient's access is capable of delivering the prescribed blood flow.</p>
			<ol style="list-style-type: none"> 5) Press the Reset key to reset the alarm. If applicable, press the Reset key again and hold for two seconds to select new alarm limits. It may be necessary to start the blood pump at a slower speed and gradually work up to the prescribed rate. If unable to reset alarm, return blood to the patient if possible. Do not return clotted blood to the patient. 6) Take the machine out of service and alert a qualified service technician.
Arterial Pressure not calibrated	Arterial pressure calibration has been lost or not set.	High Alarm	Turn machine power off and back on. If alarm is not cleared, take the machine out of service and alert a qualified service technician that arterial calibration is needed.
Arterial rate not calibrated	Arterial rate calibration has been lost or not set.	High Alarm	Turn machine power off and back on. If alarm is not cleared, take the machine out of service and alert a qualified service technician that arterial rate calibration is needed.
Assisted Reinfusion	The machine is displaying the "Assisted Reinfusion" screen. The Tx Clock is off and the blood pump is stopped	Advisory	<p>If the Assisted Reinfusion program is to be used: follow the on-screen instructions.</p> <p>If the treatment is to continue: press the Escape key to exit the "Assisted Reinfusion" screen and restart the Tx Clock on the "Home" screen and start the blood pump at the prescribed rate.</p>

Message	Purpose of Message	Type	Action Required
Auto Prime	The Auto Prime program is running.	Advisory	If the Auto Prime program is to be used: follow the on-screen instructions. If a different priming method is to be used: press the Escape key to exit the "Auto Prime" screen.
Auto Prime Complete, Press Confirm	The Auto Prime program is finished running and the bloodlines have been primed.	Dialog Message	Press the CONFIRM key to exit the "Auto Prime" screen. The "Test & Options" screen will be displayed with the results of the bloodline tests. At this point, all testing should be complete and the patient's prescription may be entered.
Auto Start: Complete	The Auto Start portion of the self-tests (excluding the four bloodline tests) have run and prepared the machine for bloodline stringing.	Advisory	Press the Reset key to clear the message. String the bloodlines on the machine and begin priming either by running the Auto Prime program or by using the Standard or Prime Amount methods.
Auto Start: Testing	The Auto Start program is running pressure and alarm tests (with the exception of the Level Detector, Arterial, Venous, and TMP tests).	Advisory	No action required. After the Auto Start portion of the alarm and pressure tests have been completed, the remaining tests will need to be run either during Auto Prime or by using the Standard or Prime Amount methods.
Balance Chamber Uncalibrated	Balancing chamber calibration has been lost or not set.	High Alarm	Turn machine power off and back on. If alarm is not cleared, take the machine out of service and alert a qualified service technician that balancing chamber calibration is needed.
Base Na+ greater than max. value	Entered Base Na+ parameter is higher than allowed.	Dialog Message	The Base Na+ will be set to the highest allowed Na+ level. Press CONFIRM to clear message and accept the maximum allowed value. Verify that the value is acceptable or enter new value.
Base Na+ has been set to min.	The operator has attempted to set a Base Na+ lower than allowed.	Dialog Message	The Base Na+ will be set to the lowest allowed Na+ level. Confirm if value is acceptable or enter new value.
bibag: +5 V Error	Electronic self-test, power supply limits exceeded.	High Alarm	Turn machine power off and back on. If the alarm is not cleared, take the machine out of service and alert a qualified service technician.
bibag: -5 V Error	Electronic self-test, power supply limits exceeded.	High Alarm	Turn machine power off and back on. If the alarm is not cleared, take the machine out of service and alert a qualified service technician.
bibag: +12 V Error	Electronic self-test, power supply limits exceeded.	High Alarm	Turn machine power off and back on. If the alarm is not cleared, take the machine out of service and alert a qualified service technician.
bibag: Bag Leak	A leak has been detected in the bag.	High Alarm (Water)	Open bibag door, wait 30 seconds to relieve the pressure, and remove the bag. Place a new bag on the connector and close the bibag door.

Message	Purpose of Message	Type	Action Required
bibag: Bag On	The bag is on the connector when user is either attempting to run a cleansing/ disinfecting program or using acetate. Or The blue bicarbonate connector is out of the bicarbonate port when a bag is on the <i>bibag</i> connector.	High Alarm (Water)	Remove the bag from the <i>bibag</i> connector if using acetate or attempting to run a cleansing/disinfecting program. Or Plug the blue bicarbonate connector back into the bicarbonate port on the machine.
bibag: Bic Pump Locked	The bicarbonate pump has been air locked for over two minutes.	High Alarm (Water)	If during treatment, rinse back the patient's blood and disconnect the patient from the machine. Run a Rinse program to clear the alarm. If the alarm is not cleared, take the machine out of service and alert a qualified service technician.
bibag Board Failure	<i>bibag</i> Interface Board cannot boot up.	High Alarm	Turn machine power off and back on. If alarm is not cleared, take the machine out of service and alert a qualified service technician.
bibag: Chamber Venting	The system is venting and the machine is in bypass mode.	Advisory	Advisory only. No action is required. Note: If this message occurs repeatedly, open the <i>bibag</i> door, wait 30 seconds to relieve the pressure, and lift the bag off the <i>bibag</i> connector nozzles to vent the air. With the white <i>bibag</i> handle facing outward, hang the <i>bibag</i> back on the <i>bibag</i> connector nozzles. Push it down until it is fully seated on the <i>bibag</i> connector nozzles. Close the <i>bibag</i> door, making sure it latches firmly in place. An audible click indicates the door is closed.
bibag: Cond Calib Err	Electronic self-test: <i>bibag</i> conductivity sensor calibration error.	High Alarm	Turn machine power off and back on. If the alarm is not cleared, take the machine out of service and alert a qualified service technician.
bibag: Cond High	The actual or measured <i>bibag</i> conductivity has exceeded the high conductivity alarm limit when using the <i>bibag</i> disposable. The machine is in bypass mode.	High Alarm (Water)	Wait five minutes for conductivity to stabilize. If the appropriate conductivity cannot be reached, connect a new bag. If the alarm is still not cleared, return blood to the patient. Take the machine out of service and alert a qualified service technician.



Message	Purpose of Message	Type	Action Required
bibag: Cond Low	<p>The actual or measured bibag conductivity is below the low conductivity alarm limit when using the bibag disposable. The machine is in bypass mode. The bibag disposable may also be nearly empty.</p>	High Alarm (Water)	<p>Check the bibag disposable: if there is only about one inch (2.5 cm) of bicarbonate left at the bottom of the bag, replace the bag. Open the bibag door, wait 30 seconds to relieve the pressure, and remove the bag. Place a fresh bag back on the connector and close the door.</p> <p>Wait five minutes for conductivity to stabilize.</p> <p>If conductivity alarm persists:</p> <ol style="list-style-type: none"> 1) Turn off the dialysate flow by selecting and confirming the Dialysate Flow on/off toggle-button on the “Dialysate” screen. 2) Gently massage the base of the bibag disposable to better mix the bicarbonate powder and remove any trapped air. 3) Turn the dialysate flow back on by selecting and confirming the Dialysate Flow on/off toggle-button on the “Dialysate” screen. 4) If the appropriate conductivity cannot be reached, connect a new bag. <p>If conductivity alarm persists,</p> <ol style="list-style-type: none"> 1) Turn off the dialysate flow by selecting and confirming the Dialysate Flow on/off toggle-button on the “Dialysate” screen. 2) Leaving the bag on the connector, pull the blue bicarbonate connector out of its rinse port. 3) Check for a clogged filter screen in the blue bicarbonate connector handle. Clean if necessary with purified water. Verify that the connector and filter assembly are tightly screwed together with no air leak. 4) Insert the blue bicarbonate connector back into its rinse port. 5) Turn the dialysate flow back on by selecting and confirming the Dialysate Flow on/off toggle-button on the “Dialysate” screen. <p>If the conductivity alarm still cannot be cleared, rinse back the patient’s blood and disconnect the patient from the machine. Run an Acid Clean program followed by a complete rinse cycle. Test machine operation.</p> <p>If conductivity alarm still persists, take the machine out of service and alert a qualified service technician.</p>
	<p> Note: Pressing the Mute key will silence this alarm for a total of six minutes at a time when using the bibag system.</p>		

Message	Purpose of Message	Type	Action Required
bibag: Cond Sensor Err	The <i>bibag</i> conductivity sensor is not reading the correct conductivity. The machine is in bypass mode.	Advisory	Insert the blue bicarbonate connector into an appropriate liquid bicarbonate source Or To use the <i>bibag</i> disposable: If during treatment, rinse back the patient's blood and disconnect the patient from the machine. Run a Rinse program until message is cleared. If the alarm is not cleared, take the machine out of service and alert a qualified service technician.
bibag: Door Error	Sensor error.	Advisory	Turn machine power off and back on. If the message is not cleared, return the blood to the patient if alarm occurs during treatment. Take the machine out of service and alert a qualified service technician.
bibag: Door Open	The <i>bibag</i> door is open. The machine is in bypass mode.	High Alarm (Water)	Close the <i>bibag</i> door to continue.
bibag: Emptied	The <i>bibag</i> emptying program has been completed. The emptied bag must be removed from the <i>bibag</i> connector.	Advisory	Open the <i>bibag</i> door and remove the bag to continue.
bibag: Empty Too Long	The bag has been emptying longer than five minutes.	High Alarm (Water)	Make sure that the blue bicarbonate connector is firmly plugged into the bicarbonate port. If the alarm is not cleared, remove bag without emptying, take the machine out of service and alert a qualified service technician.
bibag: Emptying	The bag is being emptied by the machine.	Advisory	No action required, wait until the machine has finished emptying the bag to continue.
bibag: Filling	The bag is filling with water.	Advisory	Advisory only. No action is required.
bibag: I2C Error	I ² C communication problem.	High Alarm	Turn machine power off and back on. If the alarm is not cleared, return the blood to the patient if alarm occurs during treatment. Take the machine out of service and alert a qualified service technician.
bibag: In Bypass	A <i>bibag</i> alarm or process was occurring when the operator attempted to run prime recirc. The machine is in bypass mode.	Advisory	Advisory only. No action is required. Wait until the message has cleared before selecting prime recirc again.

Message	Purpose of Message	Type	Action Required
bibag: No Bag	A bag must be on the connector to continue.	High Alarm (Water)	Place a bag on the <i>bibag</i> connector and close the door to continue.
bibag: No Comm.	The <i>bibag</i> interface board is not communicating with the actuator board.	High Alarm	Turn machine power off and back on. If the alarm is not cleared, return the blood to the patient if alarms occurs during a treatment. Take the machine out of service and alert a qualified service technician.
bibag: PHT Failed	The <i>bibag</i> online Pressure Holding Test has failed. The machine is in bypass mode.	High Alarm (Water)	<p>If the PHT failed on the “Select Program” screen:</p> <ul style="list-style-type: none"> • Turn machine power off and back on to rerun the test. • If the alarm is repeated on the next test, take the machine out of service and alert a qualified service technician. <p>If the PHT failed in Dialysis Mode:</p> <ul style="list-style-type: none"> • Make sure there are no concentrate jugs or other objects obstructing the bag or pressing against it. • Check the machine for leaks. If no leaks are detected: <ul style="list-style-type: none"> ○ Open the <i>bibag</i> door, wait 30 seconds to relieve the pressure, and remove the bag. ○ Place the bag back on the connector and close the door. The <i>bibag</i> online PHT will run again automatically. • If the alarm is repeated on the next test: <ul style="list-style-type: none"> ○ Discontinue use of the <i>bibag</i> system. ○ Insert the blue bicarbonate connector into an appropriate liquid bicarbonate source in order to continue the treatment. ○ Alert a qualified service technician.



Message	Purpose of Message	Type	Action Required
bibag: Post Rinse	The machine is rinsing the hydraulics after emptying the bag.	Advisory	Advisory only. No action is required.
bibag: Press Calib Err	bibag system pressure calibration error.	Advisory	Turn machine power off and back on. If the alarm is not cleared, take the machine out of service and alert a qualified service technician.
bibag: Press Sensor Err	The <i>bibag</i> connector pressure sensor is experiencing an error. The machine is in bypass mode.	High Alarm (Water)	Open the <i>bibag</i> door, wait 30 seconds to relieve the pressure, and remove the bag. Place the bag back on the connector and close the door. If the alarm is not cleared, return the blood to the patient if alarm occurs during treatment. Take the machine out of service and alert a qualified service technician.
bibag: Press Too High	The pressure inside the <i>bibag</i> disposable is above the set alarm limits. The machine is in bypass mode.	High Alarm (Water)	Open the <i>bibag</i> door, wait 30 seconds to relieve the pressure, and remove the bag. Place the bag back on the connector and close the door. If the alarm is not cleared: <ul style="list-style-type: none"> • Discontinue use of the <i>bibag</i> system. • Insert the blue bicarbonate connector into an appropriate liquid bicarbonate source in order to continue the treatment. • Alert a qualified service technician.
bibag: Press Too Low	The pressure inside the <i>bibag</i> disposable is below the set alarm limits. The machine is in bypass mode.	High Alarm (Water)	Open the <i>bibag</i> door, wait 30 seconds to relieve the pressure, and remove the bag. Place the bag back on the connector and close the door. If the alarm is not cleared: <ul style="list-style-type: none"> • Discontinue use of the <i>bibag</i> system. • Insert the blue bicarbonate connector into an appropriate liquid bicarbonate source in order to continue the treatment. • Alert a qualified service technician.
bibag: Select Conc 45x	The operator has attempted to start dialysis using the <i>bibag</i> system and an acid concentrate other than 45x is selected in Service Mode. Or The blue bicarbonate connector was not inserted into a liquid bicarbonate source if liquid bicarbonate dialysis is desired.	Advisory	<i>bibag</i> dialysis is compatible only with 45x acid concentrates. Either, Restart the machine and enter Service Mode and select a 45x acid concentrate before beginning dialysis; Or Use liquid bicarbonate for dialysis by inserting the blue bicarbonate connector into an appropriate liquid bicarbonate source.

Message	Purpose of Message	Type	Action Required
bibag: Temp Calib Err	Electronic self-test: temperature calibration error.	High Alarm	Turn machine power off and back on. If the alarm is not cleared, take the machine out of service and alert a qualified service technician.
bibag: Temp Sensor Err	The <i>bibag</i> temperature sensor is not reading the correct temperature.	Advisory	Insert the blue bicarbonate connector into an appropriate liquid bicarbonate source Or To use the <i>bibag</i> disposable: If during treatment, rinse back the patient's blood and disconnect the patient from the machine. Run a Rinse program until message is cleared.
bibag: Val Comm Err	The <i>bibag</i> interface board was unable to communicate with the actuator board.	High Alarm (Water)	Turn machine power off and back on. If the alarm is not cleared, return the blood to the patient if alarm occurs during treatment. Take the machine out of service and alert a qualified service technician.
bibag: Valve 1 Err	Electronic self-test failure.	High Alarm (Water)	Turn machine power off and back on. If the alarm is not cleared, return the blood to the patient if alarm occurs during treatment. Take the machine out of service and alert a qualified service technician.
bibag: Valve 2 Err	Electronic self-test failure.	High Alarm (Water)	Turn machine power off and back on. If the alarm is not cleared, return the blood to the patient if alarm occurs during treatment. Take the machine out of service and alert a qualified service technician.
bibag: Vent Too Long	The <i>bibag</i> system has been venting longer than ten minutes. The machine is in bypass mode.	High Alarm (Water)	Press the Reset key to clear the message. Pull the blue bicarbonate connector out of its port and then firmly plug it back in. If the alarm persists, rinse back the patient's blood and disconnect the patient from the machine. Take the machine out of service and alert a qualified service technician.
Bic Pump Alarm	This is a pump failure alarm.	Low Alarm	A single occurrence is not a problem if the machine automatically resets. If the problem persists for longer than one minute or occurs repeatedly, turn machine power off and back on. If the alarm is not cleared, return the blood to the patient if the alarm occurs during treatment. Take the machine out of service and alert a qualified service technician.
Bic Pump Always EOS	This is a pump failure alarm.	Low Alarm	A single occurrence is not a problem if the machine automatically resets. If the problem persists for longer than one minute or occurs repeatedly, turn machine power off and back on. If the alarm is not cleared, return the blood to the patient if the alarm occurs during treatment. Take the machine out of service and alert a qualified service technician.

Message	Purpose of Message	Type	Action Required
Bic Pump No EOS	This is a pump failure alarm.	Low Alarm	A single occurrence is not a problem if the machine automatically resets. If the problem persists for longer than one minute or occurs repeatedly, turn machine power off and back on. If the alarm is not cleared, return the blood to the patient if the alarm occurs during treatment. Take the machine out of service and alert a qualified service technician.
Bic Conn Out of Port	The blue bicarbonate connector is out of its port.	Low Alarm	Connect blue bicarbonate connector into the blue rinse port. Verify the concentrate selection.
Bicarb Cond 2 High	Bicarbonate conductivity cell is measuring high dialysate bicarbonate conductivity when using the <i>bibag</i> system. The machine is in bypass mode.	High Alarm (Water)	A single occurrence is not a problem if the machine automatically resets. If the problem lasts longer than five minutes or occurs repeatedly, turn power off and back on. If the alarm is not cleared, return the blood to the patient if the alarm occurs during treatment. Take the machine out of service and alert a qualified service technician.
	 Note: Pressing the Mute key will silence this alarm for a total of six minutes at a time when using the <i>bibag</i> system.		
Bicarb Cond 2 Low	Bicarbonate conductivity cell is measuring low dialysate bicarbonate conductivity when using the <i>bibag</i> system. The machine is in bypass mode.	High Alarm (Water)	A single occurrence is not a problem if the machine automatically resets. If the problem lasts longer than five minutes or occurs repeatedly, turn power off and back on. If the alarm is not cleared, return the blood to the patient if the alarm occurs during treatment. Take the machine out of service and alert a qualified service technician.
	 Note: Pressing the Mute key will silence this alarm for a total of six minutes at a time when using the <i>bibag</i> system.		
Bicarb Cond. Cell Uncalibrated	Bicarbonate cell #117 not calibrated.	High Alarm	Turn machine power off and back on. If the alarm is not cleared, take the machine out of service and alert a qualified service technician.

Message	Purpose of Message	Type	Action Required
Bicarb: Cond High	The actual or measured sodium bicarbonate concentrate conductivity has exceeded the high conductivity alarm limit when using the blue bicarbonate connector for liquid bicarbonate. The machine is in bypass mode.	High Alarm (Water)	Wait five minutes for conductivity to stabilize. If the appropriate conductivity cannot be reached, make sure that the correct bicarbonate source is connected. If the alarm is still not cleared, rinse back the patient's blood, and disconnect the patient from the machine. Take the machine out of service and alert a qualified service technician.
Bicarb: Cond Low	The actual or measured sodium bicarbonate concentrate conductivity is below the low conductivity alarm limit when using the blue bicarbonate connector for liquid bicarbonate. The machine is in bypass mode.	High Alarm (Water)	<p>Make certain the correct bicarbonate is connected to the machine and that there is enough concentrate available. Wait five minutes for conductivity to stabilize. If the appropriate conductivity cannot be reached:</p> <ol style="list-style-type: none"> 1) Plug the blue bicarbonate connector into its port. 2) Wait one minute and then re-connect the bicarbonate connector to the liquid bicarbonate source. 3) Wait five minutes for conductivity to stabilize. <p>If the conductivity alarm persists,</p> <ol style="list-style-type: none"> 1) Turn off the dialysate flow by selecting and confirming the Dialysate Flow on/off toggle-button on the "Dialysate" screen. 2) Disconnect the concentrate suction connectors from their wands. 3) Check for clogged filter screens in the connector handles, especially the blue bicarbonate connector. Clean if necessary with purified water. Re-assemble the connector handles. Verify that the connectors and filter assemblies are tightly screwed together with no air leak. 4) Insert the red and blue concentrate connectors back into the wands and place the wands in the jugs. Turn the dialysate flow back on by selecting and confirming the Dialysate Flow on/off toggle-button on the "Dialysate" screen. <p>If the conductivity alarm still cannot be cleared, discontinue treatment, rinse back the patient's blood and disconnect the patient from the machine. Perform an Acid Clean program followed by a complete rinse cycle. Test machine operation. If the conductivity alarm persists, take the machine out of service and alert a qualified service technician.</p>

Message	Purpose of Message	Type	Action Required
Bicarb Press Calib Err	Bicarbonate pressure calibration error. The machine is in bypass mode.	High Alarm	Turn machine power off and back on. If the alarm is not cleared, return the blood to the patient if alarm occurs during treatment. Take the machine out of service and alert a qualified service technician.
Bicarb: Temp Calib Err	Bicarbonate temperature calibration error. The machine is in bypass mode.	High Alarm	Turn machine power off and back on. If the alarm is not cleared, return the blood to the patient if alarm occurs during treatment. Take the machine out of service and alert a qualified service technician.
Bicarb: Vent Too Long	The <i>bibag</i> system has been venting longer than ten minutes when using the blue bicarbonate connector for liquid bicarbonate. The machine is in bypass mode.	High Alarm (Water)	Press the Reset key to clear the message. If the alarm persists, turn machine power off and back on. If the alarm is not cleared, return the blood to the patient if the alarm occurs during treatment. Take the machine out of service and alert a qualified service technician.
Bicarbonate greater than max. value	Entered Bicarbonate level is higher than allowed.	Dialog Message	The Bicarbonate will be set to the highest allowed bicarbonate level. Press CONFIRM to clear the message and accept the maximum allowed value. Verify that the value is acceptable or enter a new value.
Bicarbonate has been set to min.	The operator has attempted to set a Bicarbonate level lower than allowed.	Dialog Message	The Bicarbonate will be set to the lowest allowed bicarbonate level. Confirm if value is acceptable or enter new value.
Bicarbonate pump volume not calibrated	Bicarbonate pump volume calibration has been lost or not set.	High Alarm	Turn machine power off and back on. If alarm is not cleared, take the machine out of service and alert a qualified service technician that bicarbonate pump volume calibration is needed.
Blank PatientCard inserted! Press CONFIRM to save to blank PatientCard or Press Escape to cancel and insert correct PatientCard	A PatientCard with an ID saved to it was used to program the treatment but now a blank PatientCard is inserted into the PatientCard Reader slot.	Pop-Up	Either press the CONFIRM key to now save to this new, blank PatientCard Or Press the Escape key to cancel reading the blank PatientCard then insert the correct PatientCard.
Blood dimness not calibrated	Blood dimness calibration has been lost or not set.	High Alarm	Turn machine power off and back on. If alarm is not cleared, take the machine out of service and alert a qualified service technician that blood dimness calibration is needed.
Blood flow unstable	When attempting to start an OLC test, certain conditions are necessary, including stable blood flow rate.	Advisory	Wait a minute or so and start the OLC test again.

Message	Purpose of Message	Type	Action Required
Blood Leak?	<p>The blood leak detector has detected the presence of blood or air in the dialysate.</p> <hr/> <p> Note: Air or disinfectants containing peracetic acid may cause a false alarm.</p> <hr/> <p> Warning! During an override, the machine's blood leak detector is inactive. You must monitor the treatment.</p>	High Alarm (Blood)	<p>1) Press Reset to reset the alarm.</p> <p>2) Check dialysate fluid for presence of blood with a blood leak test strip.</p> <p>If test is negative, recheck with a new blood leak test strip. If negative after three checks, follow steps below:</p> <p>Press and hold Reset for three seconds to run the blood pump for up to 3 minutes while troubleshooting the alarm.</p> <ul style="list-style-type: none"> • Check the dialyzer supply and return lines for air leaks, especially at the dialyzer connectors and the filter screen in the dialyzer return line. • Press Reset to reset the alarm. <p>If unable to reset the alarm, return the patient's blood according to procedure below (test positive) and alert a qualified service technician.</p> <p>If test is positive, proceed according to facility blood leak policy. If facility policy is to return patient's blood, follow the steps below.</p> <p>1) Press Reset to reset all other blood flow alarms.</p> <p>2) Press and hold Reset for three seconds to enable the blood pump to run and return patient's blood per unit protocol.</p> <hr/> <p> Note: Pressing and holding Reset for three seconds will activate the blood pump for about three minutes while a blood leak alarm exists. Press and hold Reset again if more time is needed to return the patient's blood.</p>
Blood Leak not Calib	The blood leak detector is not in calibration.	High Alarm	Return the blood to the patient if the alarm occurs during treatment. Take the machine out of service and alert a qualified service technician.
Blood Leak not calibrated	Blood Leak calibration has been lost or not set.	Opening Screen Message	Turn machine power off and back on. If alarm is not cleared, take the machine out of service and alert a qualified service technician that blood leak calibration is needed.
Blood Pump +5 V Error	+ 5 volts is outside the allowable range	High Alarm	See message E.10
Blood Pump +12 V Error	+ 12 volts is outside the allowable range	High Alarm	See message E.07

Message	Purpose of Message	Type	Action Required
Blood Pump -12 V Error	- 12 volts is outside the allowable range	High Alarm	See message E.09
Blood Pump +24 V Error	+ 24 volts is outside the allowable range	High Alarm	See message E.08
Blood Pump Button Alarm	Key stuck or held in too long	High Alarm	See message A.16
Blood Pump Calib Alarm	Pressure was adjusted too much in calibration mode	High Alarm	See message A.26
Blood Pump Direction Error	Pump is turning in the wrong direction	High Alarm	See message A.13
Blood Pump EEPROM Err	EEPROM error	High Alarm	See message E.05
Blood Pump EPROM Error	EPROM CRC error	High Alarm	See message E.01
Blood Pump Erasing Error	Error erasing Flash ROM while in Service Mode	High Alarm	See message E.98
Blood Pump Failure	Electronic self-test failure.	High Alarm	Turn machine power off and back on. If alarm does not clear, return the blood to the patient if alarm occurs during treatment. Take the machine out of service and alert a qualified service technician.
Blood Pump Flash Error	Error copying data into Flash ROM while in Service Mode	High Alarm	See message E.97
Blood Pump RAM Error	RAM check error	High Alarm	See message E.03
Blood Pump Rate Alarm	Pump is not reaching speed at maximum voltage	High Alarm	See message A.11
Blood Pump ROM Error	Flash ROM CRC error	High Alarm	See message E.02
Blood Pump Stop Alarm	Pump rotor turning when it should not be	High Alarm	See message A.29

Message	Purpose of Message	Type	Action Required
Blood Pump Stopped	The blood pump is on and the speed is set, but the blood pump has stopped for a period exceeding its set time limit of either 15 or 30 seconds (time limit is set with dip switch #4 on the blood pump module PCB).	High Alarm (Blood)	<ol style="list-style-type: none"> 1) Correct other alarms that could have triggered the stopped pump message. 2) Inspect the blood pump module to see if: The blood pump door is closed. The pump tube segment is properly positioned. Correct if necessary. 3) Press the Reset key to reset the alarm. 4) If running double-needle dialysis with the single needle pump in the machine, the Single Needle option in the "Tests & Options" screen must be off. 5) If running single-needle dialysis with the single needle pump in the machine, the Single Needle option in the "Tests & Options" screen must be on. Next, <ul style="list-style-type: none"> • Set blood pump rate to zero • Increase the blood pump rate to 100 ml/min • Check the pillow on the arterial bloodline below the arterial blood pump for poor blood flow. 6) Slowly increase the blood pump rate to the prescribed rate. If unable to resume blood flow rate, manually return the blood to the patient if the alarm occurs during treatment. Take the machine out of service and alert a qualified service technician to replace the blood pump module.
Blood Pump Tach Alarm	Optical tachometer not in range	High Alarm	See message A.24
Blood Pump Task Error	Software task was not completed correctly	High Alarm	See message E.15
Blood Pump Timer Error	50 ms second time period exceeded	High Alarm	See message E.14
Blood Pump Update Error	Transmit error during Flash update while in Service Mode	High Alarm	See message E.99
Blood Pump Volt Error	Reference Voltage error	High Alarm	See message E.04
Blood Pump WD Error	Watchdog timeout	High Alarm	See message E.06



Message	Purpose of Message	Type	Action Required
Blood Returned	The Assisted Reinfusion program is finished running and the patient's blood has been returned.	Advisory	Select the Done button to exit the "Assisted Reinfusion" screen or, if the blood pump must run longer, press the Start/Stop key on the Blood Pump Module to run the blood pump longer.
Blood Sensed	An action has been initiated that requires that blood not be sensed. Or The operator has selected the Empty bibag button when blood is sensed. The bag cannot be emptied using the Empty bibag button when blood is sensed.	Low Alarm	1) Inspect the optical detector below the line clamp. 2) Press Reset to reset the alarm. 3) If the alarm is not cleared, return the blood to the patient if the alarm occurs during treatment. Take the machine out of service and alert a qualified service technician. Or If the treatment is not yet finished and the <i>bibag</i> disposable must be changed, lift up on the <i>bibag</i> door, wait 30 seconds to relieve the pressure, and remove the bag. Put a new bag on the connector and close the door again to continue using the <i>bibag</i> system for the treatment.
Blood Still Sensed!	The red concentrate connector was inserted into its rinse port while blood is sensed by the optical detector; the "Select Program" screen is displayed.	Low Alarm	1) Verify that there is no longer blood in the venous return line 2) Inspect the optical detector below the line clamp. 3) Press Reset to reset the alarm. 4) If the alarm is not cleared, take the machine out of service and alert a qualified service technician.
BP Comm. Timeout	Time out when receiving Intel-Hexline or overflowed received buffer.	High Alarm	See message A.27
BP Del. Rate Alarm	Actual speed-read back analog voltage at X348/10 is out of limits	High Alarm	See message A.21
BP Direction Alarm	Pump is turning in the wrong direction	High Alarm	See message A.13
BP Feedback Alarm	Arterial rate and the blood pump's arterial setting knob do not track in sync.	High Alarm	If the alarm is not cleared, return the blood to the patient if alarm occurs during treatment. Take the machine out of service and alert a qualified service technician.
BP Level Up Alarm	Pressure increase when the Level Up key is pressed	High Alarm	See message A.25

Message	Purpose of Message	Type	Action Required
BP Pressure Alarm	Arterial pressure-read back analog voltage at X348/7 is out of limits SN pressure-read back analog voltage is out of limits	High Alarm	See message A.22
BP Receive Alarm	Error in received Intel-Hex-line	High Alarm	See message A.28
BP Rotation Error	Pump rotor turning when it should not be for a second time	High Alarm	See message E.23
BP Set Rate Alarm	Set speed-read back analog voltage at X348/14 is out of limits	High Alarm	See message A.20
BPM: Cuff Press High	Blood pressure cuff is above 320 mmHg.	High Alarm	Press the Stat/Deflate key to deflate the cuff. Observe the patient for physiologic changes. Indicates a hardware malfunction. If problem persists, remove cuff and alert a qualified service technician.
BPM: Cuff Press Low	Blood pressure cuff is below 10 mmHg.	High Alarm	Check for loose connection in the inflation system. Indicates a hardware malfunction. If problem persists, remove cuff and alert a qualified service technician.
BPM: Diastolic High	The diastolic blood pressure reading is above the set Upper Diastolic alarm limit.	High Alarm	Observe the patient for physiologic changes. Treat patient as symptoms warrant.
BPM: Diastolic Low	The diastolic blood pressure reading is below the set Lower Diastolic alarm limit.	High Alarm	Observe the patient for physiologic changes. Treat patient as symptoms warrant.
BPM: Measure > 90 sec	The blood pressure test has been in progress for more than 90 seconds.	High Alarm	Press Stat/Deflate key to deflate the pressure cuff. Check the patient for signs for physiologic changes. Indicates a hardware malfunction. If problem persists, remove cuff and alert a qualified service technician.
BPM: Motion Detected	Movement of the patient, cuff tubing, or some other pressure on the detection system.	High Alarm	Observe the patient for physiologic changes. Treat patient as symptoms warrant.
BPM: Not Communicating	Blood pressure module is not communicating with the machine	High Alarm	If problem persists, alert a qualified service technician.
BPM: Not Deflating	Obstruction in inflation system or valve in blood pressure module malfunction.	High Alarm	1) Remove kink in line to cuff. 2) May indicate a hardware malfunction. If problem persists, remove cuff and alert a qualified service technician.

Message	Purpose of Message	Type	Action Required
BPM: Oscil Wave Check	The diastolic blood pressure reading is close to or greater than the systolic pressure reading.	High Alarm	Indicates a hardware malfunction. If problem persists, remove cuff and alert a qualified service technician.
BPM: Pulse > 100	Patient's heart rate is above 100 beats per minute.	High Alarm	Observe the patient for physiologic changes. Treat patient as symptoms warrant. May also indicates a hardware malfunction.
BPM: Pulse Amp Unif	The amplitude of the pressure pulses is inconsistent with an accurate blood pressure profile.	High Alarm	Check pressure cuff for proper fit and alignment. Observe the patient for physiologic changes. Treat patient as symptoms warrant.
BPM: Pulse High	The latest pulse reading is above the Upper Pulse alarm limit.	High Alarm	Observe the patient for physiologic changes. Treat patient as symptoms warrant.
BPM: Pulse Low	The latest pulse reading is below the Lower Pulse alarm limit.	High Alarm	Observe the patient for physiologic changes. Treat patient as symptoms warrant.
BPM: Pump On > 30 sec	The pump that inflates the cuff has been running longer than 30 seconds.	High Alarm	Cuff is not inflating. Check for loose tubing connections or a leak in the cuff.
BPM: Systolic High	The systolic blood pressure reading is above the set Upper Systolic alarm limit.	High Alarm	Observe the patient for physiologic changes. Treat patient as symptoms warrant.
BPM: Systolic Low	The systolic blood pressure reading is below the set Lower Systolic alarm limit.	High Alarm	Observe the patient for physiologic changes. Treat patient as symptoms warrant.
BPM: Weak Pulse	The pulse pressure is too weak to register an accurate measurement.	High Alarm	Check the cuff for proper fit and inflation. Observe the patient for physiologic changes. Treat patient as symptoms warrant.
BPM: Zero Pressure	No pressure is detected by the blood pressure module.	High Alarm	Check for a loose connection in the inflation system. Correct as necessary. If no leak found, turn the power off, then back on. If problem persists, alert a qualified service technician.
BTM test underway	The OLC test may not be started when a BTM recirculation test is underway.	Advisory	Wait for the BTM recirculation test to be completed before beginning the OLC test.
BVM Failed	The BVM module has failed	High Alarm	Press Reset to clear the message. BVM will no longer pass information to the 2008T monitor. Turn the power off and back on. If the alarm is not cleared, refer to a qualified service technician.

Message	Purpose of Message	Type	Action Required
BVM No Communication	The BVM module has lost communication with the 2008T system.	High Alarm	Press Reset to clear the message. BVM will no longer pass information to the 2008T monitor until power has been turned off and back on. If the alarm is not cleared, return the blood to the patient if alarm occurs during treatment. Take the machine out of service and alert a qualified service technician.
Cannot connect to Medical Information System! Press CONFIRM to download from PatientCard or press Escape to continue without prescription download	The PatientCard Reader cannot connect to the Medical Information System (MIS).	Pop-Up	To download the prescription from the PatientCard, press the CONFIRM key. Any changes made to the prescription by the MIS will not be downloaded. To continue without downloading the patient prescription, press the Escape key. The prescription will need to be manually entered.
CDX blocked due to alarm	The operator has attempted to display CDX during an alarm.	Advisory	The machine must be alarm free in order to access the CDX system. Correct the alarm before accessing the CDX system.
CDX Not Active	The optional CDX system is not enabled.	Dialog Message	Advisory message only. No action is required. Alert a qualified service technician if the CDX system needs to be enabled.
CDX Not Installed	The optional CDX system is enabled but the CDX system PC is not installed in the machine.	Dialog Message	Advisory message only. No action is required. Alert a qualified service technician if the CDX system needs to be installed.
Check Acid Connector	The acid connector is not fully inserted into its rinse port	Low Alarm	Insert the red acid connector firmly into its rinse port to continue.
Check cable or press 'Y' to disable Crit-Line	The 2008T hemodialysis machine has not received data from the CLiC device. The Status Box displays the Low Alarm message "Crit-Line: No Comm"	Advisory message	Check the CLiC device's USB cable: <ul style="list-style-type: none"> • Make sure the cable is securely connected to the 2008T hemodialysis machine's USB port. • Wait up to one minute for the message to clear. If the Status Box message "Crit-Line: No Comm" is not cleared, turn machine power off and back on. If the alarm is still not cleared, the CLiC device cannot be used for the dialysis treatment. <ul style="list-style-type: none"> • Disconnect the CLiC device cable from the USB port. • Press the 'Y' key on the keyboard to disable the CLiC device. • Alert a qualified service technician.

Message	Purpose of Message	Type	Action Required
Chem not Connected?	The red acid connector is still connected to the red rinse port	Low Alarm	Connect the red acid concentrate connector into its correct configuration for the operation selected.
Chemical Dwell Interrupted	A Chemical Dwell program was running but was interrupted before it could be completed.	Opening Screen Message	Run a rinse program or resume with the Chemical Dwell program if desired.
Chemical Rinse Interrupted	A Chemical/Rinse program was running but was interrupted before it could be completed.	Opening Screen Message	Run a rinse program or resume with the Chemical/Rinse program if desired.
Clock Uncalibrated	Clock calibration has been lost or not set.	High Alarm	Turn machine power off and back on. If alarm is not cleared, take the machine out of service and alert a qualified service technician that clock calibration is needed.
Concentrate Connected?	The red acid concentrate connector is not connected to the concentrate container.	Low Alarm	Connect the red acid concentrate connector to the acid supply.
Cond Offset Failure	Electronic self-test failure.	High Alarm	Turn machine power Off and back On. If the alarm is not cleared, take the machine out of service and alert a qualified service technician.
Cond Ref Failure	Electronic self-test failure.	High Alarm	Turn machine power Off and back On. If the alarm is not cleared, take the machine out of service and alert a qualified service technician.
Conductivity cells not calibrated	Conductivity cells calibration has been lost or not set.	High Alarm	Turn machine power off and back on. If alarm is not cleared, take the machine out of service and alert a qualified service technician that conductivity cells calibration is needed.

Message	Purpose of Message	Type	Action Required
Conductivity High	The actual or measured conductivity has exceeded the high conductivity alarm limit. The machine is in bypass mode.	High Alarm (Dialysate)	1) Check for the prescribed baseline Na ⁺ and Bicarbonate values on the “Dialysate” screen and re-enter the correct value for any erroneous values.
	 Note: Pressing the Mute key will silence this alarm for a total of six minutes at a time when using the bibag system.		 Note: The SVS must be off before attempting to adjust any parameter on this screen.
			2) Check that the concentrates are properly mixed and in their proper containers. Remix concentrates as needed. 3) Allow five minutes for conductivity to reach the prescribed level and adjust the conductivity alarm limit window if necessary (see “Conductivity Limits” on page 91). 4) Verify that there is flow out of the drain. 5) Replace the concentrates if it appears that the fluid is being pulled in, but the conductivity is still high. After the prescribed conductivity is reached, verify the conductivity and the pH using independent testing devices. If unable to attain prescribed conductivity, discontinue treatment and alert a qualified service technician.
Conductivity Limits set to default	The operator has entered a new concentrate in Service Mode, restarted the machine, changed the default concentrate values, and restarted the machine. The last entered concentrate has been set to the default conductivity limits.	Opening Screen Message	On the “Dialysate” screen, select the prescribed concentrate, enter the prescribed Base Na ⁺ and Bicarbonate values for the patient and press the CONFIRM key to save the new values.

Message	Purpose of Message	Type	Action Required
Conductivity Low	<p>The actual or measured conductivity has exceeded the low conductivity alarm limit. The machine is in bypass mode.</p> <p> Note: Pressing the Mute key will silence this alarm for a total of six minutes at a time when using the <i>bibag</i> system.</p>	High Alarm (Dialysate)	<ol style="list-style-type: none"> 1) Check to see if: <ul style="list-style-type: none"> • Dialysate flow is on. • The correct concentrate is selected in the “Dialysate” screen and the concentrate supply lines are connected to appropriate concentrate sources. • The prescribed concentrate and the correct baseline Na⁺ and Bicarbonate values are displayed in the “Dialysate” screen. • The supply of concentrate is adequate. • The concentrate has been mixed properly, (i.e. bicarbonate mixed well with RO water). 2) Verify that the concentrate connectors are sucking concentrate. If not: <ul style="list-style-type: none"> • Turn off dialysate flow and disconnect the concentrate suction connectors from their wands. • Check for clogged filter screens in the connector handles, especially the bicarbonate connector. Clean if necessary. Re-assemble the concentrate connectors. Verify that the connectors and filter assemblies are tightly screwed together with no air leak. • Check that the O rings on the tips of the concentrate connectors are not damaged or missing. • Reconnect the connector to the concentrate source. Turn on dialysate flow and recheck the connectors for suction. If suction is present, allow 5 minutes for conductivity to reach the prescribed level. <p>If suction is not present in both connectors, discontinue treatment and remove patient from the machine. Perform an Acid Clean program followed by a complete rinse cycle. Test machine operation. If the conductivity alarm persists, take the machine out of service and alert a qualified service technician.</p>
Conductivity out of range	When attempting to start an OLC test, certain conditions are necessary, including the condition that conductivity for both the inlet and outlet sensors be in range.	Advisory	Wait until the conductivity is stable and start the OLC test again. If the message repeats, do not use OLC until the conductivity sensors have been recalibrated.

Message	Purpose of Message	Type	Action Required
CONFIRM Base Na+	The 'New Tx Rx Warn' Service Mode option has been set and the Base Na+ value is not at the nominal 137 mEq/L.	Low Alarm	To continue with current Base Na+ setting, press the CONFIRM key. To enter the nominal value, select the Base Na+ button and, using the keyboard, enter the nominal 137 value, if prescribed, then press the CONFIRM key.
CONFIRM Bicarbonate	The 'New Tx Rx Warn' Service Mode option has been set and the Bicarbonate value is not at the nominal 33 mEq/L for NaturaLyte/GranuFlo brand concentrates or 34 mEq/L for Citrasate brand concentrates.	Low Alarm	To continue with current Bicarbonate setting, press the CONFIRM key. To enter the nominal value, select the Bicarbonate button and, using the keyboard, enter the nominal 33 or 34 value (depending on the concentrate selected), if prescribed, then press the CONFIRM key.
CONFIRM Concentrate	This message will be displayed if the user needs to confirm the concentrate selected for use.	Advisory	Press CONFIRM or change the concentrate selection and then press CONFIRM .
Connect and prime bloodlines	The Auto Start program has run and prepared the machine for bloodline stringing.	Dialog Message	String the bloodlines on the machine and begin priming either by running the Auto Prime program or by using the Standard Prime or Prime Amount methods.
Connect Concentrates!	The Auto Start program has been started but needs the concentrates connected to continue. The screen-button used to access the Dialysis program is green and states, "Auto Start Dialysis".	Low Alarm	To continue with the Auto Start program start-up: Insert the acid concentrate connector into the acid concentrate supply. Place a bibag disposable onto the bibag connector or insert the blue bicarbonate connector into the bicarbonate supply.
Connector(s) Out Of Port	An action has been initiated that requires the Acid/Bicarbonate Connectors to be in their rinse ports.	Low Alarm	Insert the concentrate connectors into their proper rinse ports.
Cooling Down	The machine is cooling down from a heat disinfect.	Advisory	Advisory message only. No action is required.
Corrupted PatientCard! Insert blank PatientCard and press CONFIRM to continue or Press Escape to cancel saving to PatientCard	An unreadable PatientCard is inserted into the PatientCard Reader slot and the information cannot be saved to the corrupt PatientCard.	Pop-Up	Either insert the correct PatientCard or a new, blank PatientCard and press the CONFIRM key to continue Or Press the Escape key to cancel saving to any PatientCard.

Message	Purpose of Message	Type	Action Required
Corrupted PatientCard! Press CONFIRM to continue. Reinsert Patient Card or insert blank PatientCard to continue	An unreadable PatientCard is inserted into the PatientCard Reader slot and the information cannot be saved to the corrupt PatientCard.	Pop-Up	Press the CONFIRM key to continue then reinsert the PatientCard. If the message is still not cleared, insert a new, blank PatientCard to continue. The machine will try to write the patient's ID, name, and birthdate to the new PatientCard.
** Cover is Open **	The dialysate shunt door is open.	Advisory	To proceed with the selected operation, close the shunt door.
Crit-Line disabled. Must verify Crit-Line.	The CLiC device must be verified before it is available for use during treatment.	Advisory message	<p>If this message is displayed <i>during the treatment</i>:</p> <ul style="list-style-type: none"> The CLiC device is not monitoring the patient. The CLiC device cannot be used until the next treatment. <p>If the message is displayed <i>before the treatment starts</i>:</p> <ul style="list-style-type: none"> Place the CLiC device on the verification filter, which is attached to its USB cable. Wait up to one minute for the message to clear. If the message clears, the CLiC device is verified. If verification fails, select the "Test & Options" screen-button and select the Verify Crit-Line button to initiate the verification process manually. <p>If the message is still not cleared, the CLiC device cannot be used for the dialysis treatment. Disconnect the CLiC device cable from the USB port and alert a qualified service technician.</p>
Crit-Line needs verification	The CLiC device has not been verified within the past 30 days. The Hct/BV Crit-Line graph on the "Crit-Line" screen will be disabled.	Advisory message	<p>Verify the CLiC device:</p> <ul style="list-style-type: none"> Place the CLiC device on the CLiC Verification Filter, which is attached to its USB cable. Wait up to one minute for the message to clear. If the message clears, the CLiC device is verified. <p>If the message is not cleared:</p> <ul style="list-style-type: none"> Select the "Test & Options" screen-button then select the Verify Crit-Line button to start the verification process manually. Wait up to one minute for the message to clear. <p>If the message is still not cleared, the CLiC device cannot be used for the dialysis treatment.</p> <ul style="list-style-type: none"> Disconnect the CLiC device cable from the USB port. Alert a qualified service technician.

Message	Purpose of Message	Type	Action Required
Crit-Line: No Blood	The Tx Clock is running and the CLiC device no longer senses blood in the Blood Chamber.	Low Alarm	<p>Check the Crit-Line Blood Chamber:</p> <ul style="list-style-type: none"> • Make sure there is proper blood flow: There should be no air or bubbles in the chamber. • Make sure the CLiC device is properly seated on the Crit-Line Blood Chamber: The device should be placed perpendicularly over the chamber and cannot be rotated up or down. <p>If the alarm is not cleared, the CLiC device cannot be used for the dialysis treatment.</p> <ul style="list-style-type: none"> • Remove the device from the Crit-Line Blood Chamber. • Disconnect the CLiC device cable from the USB port and press the Reset key to disable CLiC device. • Alert a qualified service technician.
Crit-Line: No Comm	The 2008T hemodialysis machine has not received data from the CLiC device.	Low Alarm	<p>Check the CLiC device's USB cable:</p> <ul style="list-style-type: none"> • Make sure the cable is securely connected to the 2008T hemodialysis machine's USB port. • Wait up to one minute for the message to clear. <p>If the alarm is not cleared, turn machine power off and back on. If the alarm is still not cleared, the CLiC device cannot be used for the dialysis treatment.</p> <ul style="list-style-type: none"> • Disconnect the CLiC device cable from the USB port. • Press the 'Y' key on the keyboard to disable the CLiC device. • Alert a qualified service technician.

Message	Purpose of Message	Type	Action Required
Crit-Line: Obstruction	Something is blocking the CLiC device's optical sensor.	Low Alarm	<p>Check the Crit-Line Blood Chamber:</p> <ul style="list-style-type: none"> Remove the CLiC device from the blood chamber and check for obstructions. Reattach the CLiC device to the blood chamber. Wait up to one minute for the message to clear. <p>If the alarm is not cleared, the CLiC device cannot be used for the dialysis treatment.</p> <ul style="list-style-type: none"> Remove the CLiC device from the Crit-Line Blood Chamber. Disconnect the CLiC device cable from the USB port. Press the Reset key to disable the CLiC device. Alert a qualified service technician.
Crit-Line on Filter?	To verify the CLiC device, the device must be clipped to its verification filter.	Advisory message	Place the CLiC device on the CLiC Verification Filter, which is attached to its USB cable.
Crit-Line: System Error	System error.	Low Alarm	<p>The CLiC device cannot be used for the dialysis treatment.</p> <ul style="list-style-type: none"> Disconnect the CLiC device cable from the USB port. Press the Reset key to disable the CLiC device. <p>Alert a qualified service technician.</p>
Crit-Line Verified	The verification test was successful.	Advisory message	No action required. The CLiC device is ready for use during treatment.
Cuff Pressure = XXX	This is displayed during the blood pressure measurement. The cuff pressure is XXX mmHg.	Dialog Message	No action is necessary.
Deaeration pressure not calibrated	Deaeration pressure calibration has been lost or not set.	High Alarm	Turn machine power off and back on. If alarm is not cleared, take the machine out of service and alert a qualified service technician that deaeration pressure calibration is needed.
Default Parameters	The Service Mode 'Default Rx Screen' option was set to 'Yes' and the operator has pressed and confirmed the New Tx key and the "Default Parameters" screen is now displayed.	Advisory	Enter the prescribed parameters here and select the Done button to continue or select the Done button now and enter the prescription on each of the eight dialysis screens. Afterward, the selected concentrate must be confirmed.

Message	Purpose of Message	Type	Action Required
Default Rinse Times	All rinse times have been set to default values.	Opening Screen Message	Take the machine out of service and alert a qualified service technician to set rinse times per clinic protocol.
Dial Valve Failure 1	Electronic self-test failure.	High Alarm	Turn machine power off and back on. If alarm does not clear, return the blood to the patient if alarm occurs during treatment. Take the machine out of service and alert a qualified service technician.
Dial Valve Failure 2	Electronic self-test failure.	High Alarm	Turn machine power off and back on. If alarm does not clear, return the blood to the patient if alarm occurs during treatment. Take the machine out of service and alert a qualified service technician.
Dialysate flow is off	Dialysate flow is necessary to run an OLC test.	Advisory	Do not attempt to run an OLC test unless the dialysate flow is set between 300 – 800 ml/min
Dialysate flow unstable	When attempting to start an OLC test, certain conditions are necessary, including stable dialysate flow rate.	Advisory	Wait a minute or so and start the OLC test again.
Dialysate in Bypass	The operator has attempted to begin the self-tests when the dialysate is not yet ready.	Advisory	Advisory message only. Wait until the dialysate is up to proper conductivity and temperature before running self-tests.
Dialysate Pressure not calibrated	Dialysate pressure calibration has been lost or not set.	High Alarm	Turn machine power off and back on. If alarm is not cleared, take the machine out of service and alert a qualified service technician that dialysate calibration is needed.
Dialysis	Machine is currently in Dialysis Mode.	Advisory	Advisory message only. No action is required.
Dialysis Paused	In Dialysis Mode, Tx clock is paused.	Advisory	Advisory message only. No action is required.
Dialyzer Connected?	Indicates that one of the following conditions exist: <ul style="list-style-type: none"> • Test button selected but the dialyzer supply and return lines are not on the shunt. • Dialyzer supply and return lines are on the shunt but blood is sensed and the blood flow is on. 	Advisory	To proceed, either: Connect the dialyzer supply and return lines to the shunt if the procedure requires them to be connected at this time. Or, Connect the dialyzer supply and return lines to the dialyzer if the procedure requires them to be connected at this time.
			 Note: This message may also briefly appear if the blood pump rate is set too low during setup. Raise the rate to at least 100 ml/min when the blood pump is running.

Message	Purpose of Message	Type	Action Required
DIASAFE PLUS FILTER MAINTENANCE DUE IN X DAY(S).	The Service Mode Diasafe Maintenance Reminder has been set and the DIASAFE <i>plus</i> _{US} filter must be replaced within one week. This message will appear until the DIASAFE <i>plus</i> _{US} filter has been replaced and the Diasafe Reminder in Service Mode has been reset.	Opening Screen Message	Advisory only, follow unit protocol.
Diasafe Test Failed	This message advises the operator of the status of the Diasafe self test.	Low Alarm	Press the Reset key to clear the alarm. Rerun the test. If test fails again return the blood to the patient if alarm occurs during treatment. Take the machine out of service and alert a qualified service technician to replace the DIASAFE <i>plus</i> _{US} filter if necessary
Diasafe Test Passed	This message advises the operator of the status of the Diasafe self test.	Advisory	Press the Reset key to clear the message
Diasafe Test Recovery	This message advises the operator of the status of the Diasafe self test.	Advisory	Advisory message only. No action is required.
Disinfection Log	The Disinfect Log screen-button on the "Select Program" screen was selected and the "Disinfection Log" screen is displayed.	Advisory	To view the last 1,200 disinfection events stored on the machine, use the up/down arrow keys to scroll. To save the last 1,200 disinfection events stored on the machine to a USB drive, insert a USB drive into USB Port 1. To exit this screen, press the Escape key.
Disinfection Log transfer in progress	The last 1,200 disinfection events stored on the machine are being transferred to a USB drive.	Advisory	The transfer progress is displayed as a bar graph on the right side of the screen. Wait until prompted to remove the USB drive or press the Escape key to cancel the transfer.
E.01 (Arterial or SN Blood Pump Message)	EPROM CRC error	High Alarm	If this alarm occurs in Dialysis Mode, return the blood to the patient if during a treatment. Take the blood pump module out of service and alert a qualified service technician.
E.02 (Arterial or SN Blood Pump Message)	Flash ROM CRC error	High Alarm	If this alarm occurs in Dialysis Mode, return the blood to the patient if during a treatment. Take the blood pump module out of service and alert a qualified service technician.

Message	Purpose of Message	Type	Action Required
E.03 (Arterial or SN Blood Pump Message)	RAM check error	High Alarm	If this alarm occurs in Dialysis Mode, return the blood to the patient if during a treatment. Take the blood pump module out of service and alert a qualified service technician.
E.04 (Arterial or SN Blood Pump Message)	Reference Voltage error	High Alarm	If this alarm occurs in Dialysis Mode, return the blood to the patient if during a treatment. Take the blood pump module out of service and alert a qualified service technician.
E.05 (Arterial or SN Blood Pump Message)	EEPROM error	High Alarm	If this alarm occurs in Dialysis Mode, return the blood to the patient if during a treatment. Take the blood pump module out of service and alert a qualified service technician.
E.06 (Arterial or SN Blood Pump Message)	Watchdog timeout	High Alarm	If this alarm occurs in Dialysis Mode, return the blood to the patient if during a treatment. Take the blood pump module out of service and alert a qualified service technician.
E.07 (Arterial or SN Blood Pump Message)	+ 12 volts is outside the allowable range	High Alarm	If this alarm occurs in Dialysis Mode, return the blood to the patient if during a treatment. Take the blood pump module out of service and alert a qualified service technician.
E.08 (Arterial or SN Blood Pump Message)	+ 24 volts is outside the allowable range	High Alarm	If this alarm occurs in Dialysis Mode, return the blood to the patient if during a treatment. Take the blood pump module out of service and alert a qualified service technician.
E.09 (Arterial or SN Blood Pump Message)	- 12 volts is outside the allowable range	High Alarm	If this alarm occurs in Dialysis Mode, return the blood to the patient if during a treatment. Take the blood pump module out of service and alert a qualified service technician.
E.10 (Arterial or SN Blood Pump Message)	+ 5 volts is outside the allowable range	High Alarm	If this alarm occurs in Dialysis Mode, return the blood to the patient if during a treatment. Take the blood pump module out of service and alert a qualified service technician.
E.14 (Arterial or SN Blood Pump Message)	50 ms second time period exceeded	High Alarm	If this alarm occurs in Dialysis Mode, return the blood to the patient if during a treatment. Take the blood pump module out of service and alert a qualified service technician.
E.15 (Arterial or SN Blood Pump Message)	Software task was not completed correctly	High Alarm	If this alarm occurs in Dialysis Mode, return the blood to the patient if during a treatment. Take the blood pump module out of service and alert a qualified service technician.
E.23 (Arterial or SN Blood Pump Message)	Pump rotor turning when it should not be for a second time	High Alarm	If this alarm occurs in Dialysis Mode, return the blood to the patient if during a treatment. Take the blood pump module out of service and alert a qualified service technician.

Message	Purpose of Message	Type	Action Required
E.97 (Arterial or SN Blood Pump Message)	Error copying data into Flash ROM while in Service Mode	High Alarm	If this alarm occurs in Dialysis Mode, return the blood to the patient if during a treatment. Take the blood pump module out of service and alert a qualified service technician.
E.98 (Arterial or SN Blood Pump Message)	Error erasing Flash ROM while in Service Mode	High Alarm	If this alarm occurs in Dialysis Mode, return the blood to the patient if during a treatment. Take the blood pump module out of service and alert a qualified service technician.
E.99 (Arterial or SN Blood Pump Message)	Transmit error during Flash update while in Service Mode	High Alarm	If this alarm occurs in Dialysis Mode, return the blood to the patient if during a treatment. Take the blood pump module out of service and alert a qualified technician.
EEPROM already used, Power Off, Replace EEPROM	Advisory message when uploading hardware key option	Advisory	Put in a new hardware key or calibration EEPROM in IC 20 and power up.
EEPROM Missing or Reading Error	During startup, the machine cannot properly read the EEPROM memory chip	Opening Screen Message	Turn the machine off and try to power up again. If the message repeats, take the machine out of service and alert a qualified service technician.
Emptying	The blue dialysate line connector is on the shunt with door closed, the red dialysate line connector remains on the dialyzer in order to drain the dialysate compartment.	Low Alarm	If this message occurs when the dialyzer is not being emptied, take the machine out of service and alert a qualified service technician.
Emptying Stopped	When air is sensed, emptying will stop.	Low Alarm	Connect the red dialyzer return line to the shunt. If the alarm is repeated, take the machine out of service and alert a qualified service technician.
Emptying too long	The dialyzer empty program has exceeded its maximum limit.	High Alarm	If blood is not sensed, return the dialyzer supply and return lines to the shunt and close the shunt door to terminate the program. If the machine was in dialysis (blood sensed), turn machine power off and back on to clear the program.
Enter concentrate not calibrated	Concentrate calibration has been lost or not set.	High Alarm	Turn machine power off and back on. If alarm is not cleared, take the machine out of service and alert a qualified service technician that concentrate calibration is needed.
Enter Information	A blank PatientCard has been inserted into the machine and a patient ID, name, and birthdate must be entered in order to use the PatientCard with the treatment.	Advisory	Enter the required information and select the Save button to continue or, if this blank PatientCard is not desired, remove the card from the PatientCard Reader.

Message	Purpose of Message	Type	Action Required
Enter Name	A change has been made that requires the user's name to be entered using the keyboard.	Advisory	Enter the user's name and press the CONFIRM key to save the change or press the Escape key to exit without saving the change.
Error Reading Flash	Electronic Self Test	High Alarm	Turn machine power off and back on. If alarm is not cleared, take the machine out of service and alert a qualified service technician.
Fail * 9 Volt Battery	9V Power Failure Battery test has failed.	Test Message	Replace Battery
Fail * Actuator Arterial High Fail * Actuator Arterial Low	Arterial Pressure test has failed.	Test Message	Rerun test, if failure repeats, remove machine from service and alert a qualified service technician.
Fail * Actuator Conductivity High Fail * Actuator Conductivity Low	Conductivity test has failed.	Test Message	Rerun test, if failure repeats, remove machine from service and alert a qualified service technician.
Fail * Actuator Temperature High Fail * Actuator Temperature Low	Temperature test has failed.	Test Message	Verify stable temp. Rerun test. If failure repeats, remove machine from service and alert a qualified service technician to recalibrate if failure repeats
Fail * Actuator TMP High Fail * Actuator TMP Low	Transmembrane Pressure (TMP) test has failed.	Test Message	Rerun test. If failure repeats, remove machine from service and alert a qualified service technician.
Fail * Actuator Venous High Fail * Actuator Venous Low	Venous Pressure test has failed.	Test Message	Rerun test, if failure repeats, remove machine from service and alert a qualified service technician.
Fail * Air Detector	Air Detector test has failed.	Test Message	Reposition venous drip chamber. Rerun Test. If failure repeats, remove machine from service and alert a qualified service technician.





Message	Purpose of Message	Type	Action Required
Fail * Arterial High Soft Fail * Arterial Low Soft Fail * Arterial High Hard Fail * Arterial Low Hard	Arterial Pressure test has failed.	Test Message	Rerun test, if failure repeats, remove machine from service and alert a qualified service technician.
Fail * Blood Leak 1 Fail * Blood Leak 2	Blood Leak test has failed.	Test Message	Verify absence of air bubbles in flow indicator. Rerun test. If failure repeats, remove machine from service and alert a qualified service technician.
Fail * Cond High Soft Fail * Cond Low Soft	Conductivity test has failed.	Test Message	Rerun test, if failure repeats, remove machine from service and alert a qualified service technician.
Fail * (Get Neg TMP)	Get Neg TMP test has failed.	Test Message	Check UF pump. Rerun test. If failure repeats, remove machine from service and alert a qualified service technician.
Fail * (Get Pos TMP)	Get Pos TMP test has failed.	Test Message	Rerun test. If failure repeats, remove machine from service and alert a qualified service technician.
Fail * Independent Conductivity	The Independent Conductivity self-test on the "Test & Options" screen has failed.	Test Message	Rerun test. If failure repeats, remove machine from service and alert a qualified service technician.
Fail * Neg Flow On	Negative flow on pressure holding test failed	Test Message	Rerun test. If failure repeats, remove machine from service and alert a qualified service technician.
Fail * Neg Stabilize	Negative flow stabilize test failed.	Test Message	Rerun test. If failure repeats, remove machine from service and alert a qualified service technician.
Fail * Optical Detect	Optical Detector test has failed.	Test Message	Rerun test, if failure repeats, remove machine from service and alert a qualified service technician.
Fail * Pos Flow Off	Positive flow off pressure holding test failed	Test Message	Rerun test. If failure repeats, remove machine from service and alert a qualified service technician.
Fail * Pos Stabilize	Positive flow stabilize test failed.	Test Message	Rerun test. If failure repeats, remove machine from service and alert a qualified service technician.
Fail * (Remove Air)	Remove air test failed.	Test Message	Rerun test. If failure repeats, remove machine from service and alert a qualified service technician.

Message	Purpose of Message	Type	Action Required
Fail * Temp High Soft Fail * Temp Low Soft	Temperature test has failed.	Test Message	Verify stable temp. Rerun test. If failure repeats, remove machine from service and alert a qualified service technician to recalibrate.
Fail * Temp High Hard Fail * Temp Low Hard	Temperature test has failed.	Test Message	Verify stable temp. Rerun test. If failure repeats, remove machine from service and alert a qualified service technician to recalibrate.
Fail * TMP High Soft Fail * TMP Low Soft Fail * TMP High Hard Fail * TMP Low Hard	Transmembrane Pressure (TMP) test has failed.	Test Message	Rerun test. If failure repeats, remove machine from service and alert a qualified service technician.
Fail * Ven High Soft Fail * Ven Low Soft Fail * Ven High Hard Fail * Ven Low Hard	Venous Pressure test has failed.	Test Message	Rerun test, if failure repeats, remove machine from service and alert a qualified service technician.
Failed saving to PatientCard!	The PatientCard Reader has failed and cannot save to the PatientCard.	Pop-Up	Manually record the treatment values and alert a qualified service technician that the PatientCard Reader has failed.
** Failed Sending Data to Actuator Board **	Functional to Actuator board communication problem during startup.	High Alarm	Turn machine power off and back on. If alarm is not cleared, take the machine out of service and alert a qualified service technician.
Fill for Diasafe Test	This message indicates the status of the Diasafe test	Advisory	Advisory only. No action is required.
Fill Program Alarm	A Fill program has occurred for one minute while blood is sensed.	High Alarm	Inspect for air in the system. Correct as required. If the alarm is not cleared, return the blood to the patient if alarm occurs during treatment. Take the machine out of service and alert a qualified service technician.
Filling Program	A Fill program is in progress.	Advisory	Advisory only. No action is required.

Message	Purpose of Message	Type	Action Required
Flow Error	General Flow Alarm	Low Alarm	<p>A single occurrence is not a problem if the machine automatically resets. If the problem persists for longer than one minute or occurs repeatedly:</p> <ol style="list-style-type: none"> 1) Check the water supply flow to the machine. 2) Check that the Dialysate Flow is on. 3) Check the dialyzer supply and return lines for kinks. 4) Set Dialysate Flow in the "Home" screen to 500 ml/min and verify that the flow from the drain line is 500 ml/min \pm 50 ml/min. 5) Turn the power off and on. If alarm is not cleared, return the blood to the patient if alarm occurs during treatment. 6) Take the machine out of service and alert a qualified service technician.
Flow Inlet Error	Float Switch	Low Alarm	<p>A single occurrence is not a problem if the machine automatically resets. If the problem persists for longer than one minute or occurs repeatedly:</p> <ol style="list-style-type: none"> 1) Check the water supply flow to the machine. 2) Set Dialysate Flow in the "Home" screen to 500 ml/min and verify that the flow from the drain line is 500 ml/min \pm 50 ml/min. 3) Turn the power off and on. If the alarm is not cleared, return the blood to the patient if the alarm occurs during treatment. 4) Take the machine out of service and alert a qualified service technician.
Flow is Off	Dialysate flow is off.	Low Alarm	An action has been initiated that requires the dialysate flow to be on. To proceed with the selected operation, turn the dialysate flow on.
Flow pressure not calibrated	Flow pressure calibration has been lost or not set.	High Alarm	Turn machine power off and back on. If alarm is not cleared, take the machine out of service and alert a qualified service technician that flow pressure calibration is needed.
Flow Rate not Set	If the dialysate flow is turned on while the display screen flow rate selection is still "OFF", this reminder is displayed.	Advisory	Set the dialysate flow rate to the desired value.



Message	Purpose of Message	Type	Action Required
Flow Recirc Error 1	Dialysate flow problem.	Low Alarm	<p>A single occurrence is not a problem if the machine automatically resets. If the problem persists for longer than one minute or occurs repeatedly:</p> <ol style="list-style-type: none"> 1) Check the water supply flow to the machine. 2) Check that the Dialysate Flow is on. 3) Set Dialysate Flow in the “Home” screen to 500 ml/min and verify that the flow from the drain line is 500 ml/min \pm 50 ml/min. 4) Turn the power off and on. If the alarm is not cleared, return the blood to the patient if the alarm occurs during treatment. 5) Take the machine out of service and alert a qualified service technician.
Flow Recirc Error 2	Dialysate flow problem.	Low Alarm	<p>A single occurrence is not a problem if the machine automatically resets. If the problem persists for longer than one minute or occurs repeatedly:</p> <ol style="list-style-type: none"> 1) Check the water supply flow to the machine. 2) Check that the Dialysate Flow is on. 3) Set Dialysate Flow in the “Home” screen to 500 ml/min and verify that the flow from the drain line is 500 ml/min \pm 50 ml/min. 4) Turn the power off and on. If the alarm is not cleared, return the blood to the patient if alarm occurs during treatment. 5) Take the machine out of service and alert a qualified service technician.
Front Panel No Comm	The processor is unable to communicate with the front panel.	Opening Screen Message	Turn machine power off and back on. If failure repeats, return the blood to the patient if the alarm occurs during treatment. Take the machine out of service and refer to a qualified service technician.
Greater than max. value	Entered parameter is larger than allowed.	Dialog Message	Verify that the maximum value is acceptable. Press CONFIRM to clear message and accept the maximum allowed value.

Message	Purpose of Message	Type	Action Required
Heat Disinfection Interrupted	A Heat Disinfection program was running but was interrupted before it could be completed.	Opening Screen Message	Run a rinse program or resume with the Heat Disinfection program if desired.
Heat Relay Test Fail	Electronic self-test failure.	High Alarm	Turn machine power off and back on. If alarm is not cleared, take the machine out of service and alert a qualified service technician.
Heparin Dwell Complete	The five minute timer for a manual heparin bolus has elapsed.	Advisory	Press the Reset key to clear the message. The Status Light will stop flashing.
Heparin module option disabled in Service Mode	A heparin prescription is on the PatientCard but the machine is not set up to deliver heparin	Pop-Up	Press CONFIRM to clear the message and infuse prescribed heparin manually or alert a qualified service technician to install a heparin pump in the machine.
Heparin Pump Alarm	<p>The Heparin pump is encountering resistance.</p> <p> Note: An alarm will sound when the heparin pump has reached the end of its stroke during normal operation.</p>	High Alarm	<ol style="list-style-type: none"> 1) Check the heparin line for clamps or kinks and correct. 2) Check the heparin syringe for adequate amount of heparin and correct. 3) Ensure the correct type of syringe is loaded and locked in place properly. 4) Press Reset to clear the alarm and restart the heparin pump. 5) If the alarm will not reset or continues to alarm intermittently, return the blood to the patient if alarm occurs during treatment. 6) Take the heparin pump out of service and alert a qualified service technician.
High Flow Error	Possible balancing chamber problem.	Low Alarm	<p>A single occurrence is not a problem if the machine automatically resets. If the problem persists for longer than one minute or occurs repeatedly:</p> <ol style="list-style-type: none"> 1) Check the water supply flow to the machine. 2) Check that the Dialysate Flow is on. 3) Set Dialysate Flow in the "Home" screen to 500 ml/min and verify that the flow from the drain line is 500 ml/min \pm 50 ml/min. 4) Turn the power off and on. If the alarm is not cleared, return the blood to the patient if the alarm occurs during treatment. 5) Take the machine out of service and alert a qualified service technician.

Message	Purpose of Message	Type	Action Required
High Temperature	The actual dialysate temperature has exceeded the high-temperature alarm limit. Machine is in bypass mode.	High Alarm (Dialysate)	<ol style="list-style-type: none"> 1) Ensure that water is flowing to machine when turned on. 2) Check water supply to machine for excess temperature and correct if necessary. 3) If heat disinfection was recently performed, place machine in rinse cycle to decrease temperature. 4) Check the Temperature value in the “Home” screen. Re-enter it if necessary and allow five minutes for the temperature to stabilize. 5) Check that the dialysate flow at drain line is 500 ml/min ± 50 ml. 6) If unable to reach prescribed temperature, return the blood to the patient if the alarm occurs during treatment. 7) Take the machine out of service, discontinue treatment and alert a qualified service technician.
	<p> Note: If the temperature fluctuates between High Temperature and Low Temperature, see “Variable Temperature.”</p> <p> Note: Pressing the Mute key will silence this alarm for a total of six minutes at a time when using the bibag system.</p>		
<p> Warning! Hemolysis of blood in the dialyzer may occur should the dialysate exceed a temperature of 42 °C. Dialysate temperatures <u>must</u> be maintained below this level. Do not return hemolyzed blood to the patient.</p>			<p> Caution: Do not use the Heat Disinfect cycle until the machine has been repaired. If you are unable to attain proper dialysate temperature, return the blood to the patient if the alarm occurs during treatment. Take the machine out of service and alert a qualified service technician.</p>
Hold CONFIRM to Prime	In “Heparin” screen, after selecting Heparin Prime button, operator must press and hold CONFIRM to prime heparin line.	Dialog Message	Press and hold the CONFIRM key to prime the heparin line.
I2C Read Time Out I2C Bus Read Error I2C Bus Read Too Long I2C Byte Write Error	Functional to I2C EEPROM communication problem.	High Alarm	Turn machine power off and back on. If the alarm is not cleared, return the blood to the patient if alarm occurs during treatment. Take the machine out of service and alert a qualified service technician.

Message	Purpose of Message	Type	Action Required
In bypass for 8 min	Press Reset to clear the message	Advisory	<p>The machine was in bypass for about eight minutes. This may extend the time necessary to complete the treatment or rinsing of germicide. Press Reset to clear the message.</p> <p> Warning! If rinsing germicide from the dialyzer when this occurs, additional time will be necessary to fully rinse the germicide from the dialyzer. Always check for residual germicide using the appropriate approved residual test method.</p>
Insert USB drive into monitor side port	On the “Disinfection Log” screen, the user may insert a USB drive to save the last 1,200 disinfection events stored on the machine.	Dialog Message	<p>To save the last 1,200 disinfection events stored on the machine to a USB drive, insert a USB drive into USB Port 1.</p> <p>To exit this screen, press the Escape key.</p>
INTERRUPT RINSE? Escape or CONFIRM	Press CONFIRM to interrupt rinse.	Dialog Message	Press CONFIRM to accept or press Escape to cancel.
Interrupted	The selected Rinse program has been interrupted.	Low Alarm	Re-insert the dialysate connectors into the proper rinse ports. To continue the Rinse or other program, press CONFIRM , then reselect the desired program.
Invalid Data Entry for [item]	Entry value for [item] is out of range	Dialog Message	Set appropriate value for [item]
Invalid UF Rate	Entry value for goal is out of range.	Dialog Message	Readjust rate
Invalid UF Time	Entry value for goal is out of range.	Dialog Message	Readjust time
Less than minimum value	Entered parameter is smaller than allowed	Dialog Message	Verify that the minimum value is acceptable. Press CONFIRM to clear the message and accept the minimum allowed value.
Lost Battery RAM Data	The battery RAM memory has been lost.	Opening Screen Message	Verify all treatment settings before using the machine.
Lost BP Readings!	The blood pressure readings have been lost.	Opening Screen Message	Verify all blood pressure settings before using the machine.
Lost Dial Settings!	The dialysate settings have been lost.	Opening Screen Message	Verify all dialysate settings before using the machine.

Message	Purpose of Message	Type	Action Required
Lost Hep Pump Data!	The heparin pump data have been lost.	Opening Screen Message	Verify all heparin settings before using the machine.
Lost Hour Meter Data!	The latest hour meter records have been lost	Opening Screen Message	Turn machine power off and back on. If message is not cleared, take the machine out of service and alert a qualified service technician that the hour meter data has been lost.
Lost In-Line Flags!	The fluid in line record has be lost	Opening Screen Message	Turn machine power off and back on. If message is not cleared, take the machine out of service and alert a qualified service technician.
Lost Misc Settings!	Miscellaneous settings have been lost.	Opening Screen Message	Verify all treatment settings before using the machine.
Lost Power-Up Flags!	Power-up flags have been lost.	Opening Screen Message	Verify all treatment settings before using the machine.
Lost Scheduler Settings!	Scheduler settings have been lost and programs like Auto Start and Auto Heat Disinfection will not automatically start without being reprogrammed.	Opening Screen Message	Advisory only, contact a qualified service technician before the next scheduled disinfection.
Lost Some Concentrate Info!	Some concentrate information has been lost.	Opening Screen Message	Verify all concentrate settings before using the machine.
Lost SVS/UF Settings!	The blood pressure readings have been lost.	Opening Screen Message	Verify all SVS and UF settings before using the machine.
Low Acetate Warning	20% of concentrate left in acetate jug per entered value.	Low Alarm	Check jug level, change to new jug of concentrate if needed and reenter jug volume.
Low Acid Warning	20% of concentrate left in acid jug per entered value.	Low Alarm	Check jug level, change to new jug of concentrate if needed and reenter jug volume.
Low Acid/Bicarb Warn	20% of concentrate left in acid and bicarbonate jug per entered value.	Low Alarm	Check jug level, change to new jug of concentrate if needed and reenter jug volume.
Low Bicarb Warning	20% of concentrate left in bicarbonate jug per entered value.	Low Alarm	Check jug level, change to new jug of concentrate if needed and reenter jug volume.

Message	Purpose of Message	Type	Action Required
Low Flow Error	Possible balancing chamber problem.	Low Alarm	<p>A single occurrence is not a problem if the machine automatically resets. If the problem persists for longer than one minute or occurs repeatedly:</p> <ol style="list-style-type: none"> 1) Check the water supply flow to the machine. 2) Check that the Dialysate Flow is on. 3) Set Dialysate Flow in the "Home" screen to 500 ml/min and verify that the flow from the drain line is 500 ml/min \pm 50 ml/min. 4) Turn the power off and on. If the alarm does not clear, return the blood to the patient if alarm occurs during treatment. 5) Take the machine out of service and alert a qualified service technician.
Low Temperature	<p>The actual dialysate temperature has exceeded the low-temperature alarm limit. Machine is in bypass mode.</p> <p> Note: If the temperature fluctuates between High Temperature and Low Temperature, see "Variable Temperature."</p> <p> Note: Pressing the Mute key will silence this alarm for a total of six minutes at a time when using the bibag system.</p>	High Alarm (Dialysate)	<ol style="list-style-type: none"> 1) Check that the machine is in Dialysis Mode and the dialysate flow is on. 2) Check that the heater switch on the back panel is in the on () position. 3) Check the water supply to the machine for excessively cold temperature and correct. 4) Check the Temperature value in the "Home" screen. Re-enter it if necessary and allow five minutes for the temperature to stabilize. 5) If unable to attain the prescribed temperature, return the blood to the patient if alarm occurs during treatment. 6) Take the machine out of service and alert a qualified service technician.
Low Volume Mode Set!	The 'Low Volume' option on the "Test & Options" screen is set to 'On'.	Advisory	Advisory only, no action required. If this treatment will be for a patient weighing over 40 kg, be sure to set the 'Low Volume' option on the "Test & Options" screen to 'Off' before inserting the PatientCard.
Low Volume disabled: incompatible BPM!	A blood pressure module incompatible with the Low Volume setting is installed. The Low Volume setting will be set to Off and disabled.	Advisory	Advisory only, no action required. If the Low Volume setting is desired, contact Fresenius Medical Care Technical Support for information on ordering alternative blood pressure modules that are compatible with Low Volume Mode.

Message	Purpose of Message	Type	Action Required
Low Volume Patient? Y (1) / N (2)	The Stat/Deflate key was pressed while the “Select Program” screen is displayed.	Dialog Message	Press the 1 key for a Low Volume patient (weighing 20 to 40 kg) or press the 2 key for a standard patient. The machine will then measure the blood pressure through the blood pressure cuff.
Lower Dia. has been set to Min [Max]	The operator has attempted to set the lower diastolic pressure limit higher or lower than allowed.	Dialog Message	The machine has set the limit to the highest or lowest value allowed. Verify that the limit setting is acceptable.
Lower Pulse has been set to Min [Max]	The operator has attempted to set the lower pulse rate limit higher or lower than allowed.	Dialog Message	The machine has set the limit to the highest or lowest value allowed. Verify that the limit setting is acceptable.
Lower Sys. has been set to Min [Max]	The operator has attempted to set the lower systolic pressure limit higher or lower than allowed.	Dialog Message	The machine has set the limit to the highest or lowest value allowed. Verify that the limit setting is acceptable.
Machine in T&C MODE	The ‘T and C Mode’ option in Service Mode option has wrongly been set.	Opening Screen Message	Take the machine out of service and alert a qualified service technician to turn off T and C mode.
Max UF rate reached. Select new Goal or Time	This message informs the operator that the calculated UF rate is higher than the internal selection allows.	Dialog Message	In the “Home” screen, decrease the UF Goal or increase the UF Time.
Max UF Removed	The UF removed amount has reached 9999 ml and the UF pump has stopped.	Low Alarm	Follow facility protocol to stop the treatment.
Max UF time reached. Select new Goal or Rate	This message informs the operator that the calculated UF time is higher than the maximum allowed.	Dialog Message	In the “Home” screen, decrease the UF Time

Message	Purpose of Message	Type	Action Required
Minor Blood Leak?	A minor blood leak (approximately 0.35 – 0.45 ml/min) was detected in the dialysate. Air can cause a false alarm.	Low Alarm	Press Reset to reset the alarm. Press and hold Reset for three seconds to continue to run the blood pump if the alarm cannot be reset.
	 Warning! During an override, the machine's blood leak detector is inactive. You must manually monitor the treatment for evidence of blood leak.		<p>Check dialysate fluid from the red dialyzer return line for presence of blood with a blood leak test strip.</p> <p>If test is negative, recheck with a new blood leak test strip. If negative after three checks, follow steps below:</p> <p>Press and hold Reset for three seconds to continue to run the blood pump while troubleshooting the alarm.</p> <p>Check the dialyzer supply and dialyzer return lines for air leaks, especially at the connectors and the filter in the dialyzer return line.</p> <p>Press Reset to reset alarm.</p> <p>If unable to reset the alarm, return the patient's blood according to procedure below (test positive) and alert a qualified service technician.</p> <p>If test is positive, proceed according to the unit's blood-leak policy. If facility policy is to return patient's blood, follow the steps below.</p> <p>Press Reset to reset all other blood flow alarms.</p> <p>Press and hold Reset for three seconds to enable the blood pump to run and return patient's blood per unit protocol.</p>
Motherboard EEPROM Error!	The EEPROM on the motherboard has failed.	Opening Screen Message	Turn machine power off and back on. If message is not cleared, take the machine out of service and alert a qualified service technician.
Must Be Alarm Free	A conductivity alarm exists when an SVS program attempted to start.	Advisory	The machine must be alarm free in order to run an SVS program. Correct the alarm before starting the SVS program.
Must Calibrate to Run	Calibrations have been lost or not set.	High Alarm	Turn machine power off and back on. If alarm is not cleared, take the machine out of service and alert a qualified service technician that calibrations are needed.

Message	Purpose of Message	Type	Action Required
Must Clear UF Removed	An action has been initiated that requires the UF Removed to be cleared to zero.	Low Alarm	To proceed with the selected operation, set the UF Removed treatment button to zero.
Must Run Test First	The Forced Test is required before proceeding with UF or SVS.	Low Alarm	To proceed with the selected operation, run the Pressure and Alarm tests. For more information, see "Forced Test" on page 315.
Must run Both Tests before Auto Prime	Auto Prime cannot run without first running the self-tests	Dialog Message	To use the Auto Prime feature, first run the self-tests by selecting the Both Tests button.
Na ⁺ and Bicarbonate values not set to nominal values	The 'New Tx Rx Warn' Service Mode option has been set and the Base Na ⁺ value is not at the nominal 137 mEq/L or the Bicarbonate value is not at the nominal 33 mEq/L for NaturaLyte/GranuFlo brand concentrates or 34 mEq/L for Citrasate brand concentrates.	Pop-Up	Press the CONFIRM key to continue and review each of the concentrate settings in the following prompts.
Need Blood Sensed!	An action has been initiated that requires that blood is sensed.	Dialog Message	Verify venous bloodline is in the Optical Detector.
Neg. Access Flow value	This message is an advisory message that the Access Flow test result was a negative value. A positive value is expected. This can occur if the bloodlines were initially connected in the reversed position.	Low Alarm	Press CONFIRM to clear the message. Check that the bloodlines are properly connected and repeat the Access Flow test.
Negative error AF value	This message is an advisory message that the Access Flow test result was an erroneous value.	Low Alarm	Press CONFIRM to clear the message. Check that the bloodlines are properly connected and repeat the Access Flow test.
New Art Limits chosen	This message advises the operator that a new set of arterial limits has been set.	Advisory	Advisory only. No action is required.
New features loaded, Power Off, Replace EEPROM	Advisory message when uploading hardware key option	Advisory	Put the original calibration EEPROM in IC 20 and restart the machine.
New TMP Limits chosen	This message confirms that a new set of TMP limits have been set.	Advisory	Advisory only. No action is required.

Message	Purpose of Message	Type	Action Required
New Ven Limits chosen	New venous alarm limits are set	Advisory	Advisory only. No action is required.
No 8mm in Low Volume	The Low Volume option on the "Test & Options" screen is 'On' and the blood pump module needs to be set for blood pump segments no larger than 6.4mm.	High Alarm	Set the blood pump module for the diameter of the Low Volume pump segment by opening the blood pump door and pressing the Up (▲) and Down (▼) keys on the blood pump module simultaneously. The display will flash. Next press the Up (▲) or Down (▼) key on the blood pump module until the diameter of the pump segment being used is displayed. Close the blood pump door again. Or, if the Low Volume setting is not desired, on the "Test & Options" screen set the Low Volume toggle-button to 'Off'.
No Air Detector Alarm	The Prime key has been pressed. A level detector alarm must exist for this function to occur	Advisory	If the venous chamber has fluid detected, the prime function will not occur. Press Reset to start the blood pump. If a level detector alarm occurs, then press the Prime key.
No Chemical Intake	During the main program of chemical rinse or chemical dwell, the machine cannot get any chemical in the acid connector.	High Alarm	Retry chemical rinse and if problem persist, remove machine from service and alert a qualified service technician.
No Na ⁺ Selected	This is a prompt to the operator that a Start Na ⁺ value for SVS has not been set.	Advisory	To proceed with the SVS operation, set a value for Start Na ⁺ in the "SVS" subscreen.
No prescription available on Medical Information System or PatientCard	A PatientCard with no prescription is inserted in the PatientCard Reader.	Pop-up	Press the CONFIRM key to enter a new prescription for the selected patient on the "Prescription" screen. The "Prescription" screen will then be displayed with default treatment parameters.
No Program Selected	This is a prompt to the operator that a Profile was not selected.	Advisory	To proceed with an SVS operation, select an SVS Profile from the "SVS" subscreen.
No SVS Time Selected	This is a prompt to the operator that the SVS Time has not been set.	Advisory	To proceed with the SVS operation, set the SVS Time button in the "SVS" subscreen.
No valid boot loader software found	No valid software is found in order to boot up the machine	High Alarm	Take the machine out of service and alert a qualified service technician.
No valid software found	No valid software is found on the Functional board	High Alarm	Take the machine out of service and alert a qualified service technician.

Message	Purpose of Message	Type	Action Required
No Water	A water inlet valve alarm has occurred. The machine is not receiving enough water.	Low Alarm	Inspect the treated water source supplying the machine. Correct as required. If the alarm does not clear, return the blood to the patient if alarm occurs during treatment. Take the machine out of service and alert a qualified service technician.
Not Entered	The serial number cannot be displayed on the "Select Program" screen because it was not entered in Service Mode.	Advisory	Alert a qualified service technician and follow unit protocol.
OLC allowed in X minutes	There is a minimum waiting period necessary between OLC tests	Advisory	Wait the indicated time and start the OLC test again.
OLC option disabled in Service Mode	An OLC prescription is on the PatientCard but the machine is not set up to measure OLC	Pop-Up	Press CONFIRM to clear the message and continue without OLC or alert a qualified service technician to install the OLC feature in the machine.
OLC steps not calculated	In order to do the OLC test, the machine must calculate the pump steps necessary to raise and lower the conductivity for the test. This cannot be done until stable conductivity has been achieved.	Advisory	Wait a couple of minutes after the conductivity is stable and start the OLC test again.
OLC Test Cancelled!	User has cancelled OLC self test or a condition occurred during the test causing it to cancel.	Advisory	Advisory only no action required
OLC Test Failed	OLC self test failed	Low Alarm	Restart machine to rerun the OLC self test.
OLC Test Passed	OLC self test passed	Advisory	Advisory only no action required
Online Clearance Self-test	Machine is running an OLC self-test	Advisory	Advisory only no action required
Online Clearance Test	Machine is running an OLC measurement	Advisory	Advisory only no action required
Online PHT Failed	The online Pressure Holding Test has failed.	Low Alarm	Reset the alarm. Check the machine for liquid leaks. If the failure message is repeated on the next test (12 minutes between tests), return the blood to the patient if alarm occurs during treatment. Take the machine out of service and alert a qualified service technician.

Message	Purpose of Message	Type	Action Required
Online PHT Too Long	Electronic self-test failure.	High Alarm	Turn machine power off and back on. If alarm is not cleared, return the blood to the patient if alarm occurs during treatment. Take the machine out of service and alert a qualified service technician.
Only one can be set per group	The operator has attempted to set two conflicting module options.	Advisory	Select either BVM and BTM or Crit-Line if desired.
Open arterial and venous patient line clamps!	Auto Prime cannot continue because clamps are closed on the patient line.	Pop-up	Make sure the arterial and venous clamps on either side of the recirculation piece are open then press the CONFIRM key to continue.
Oxygen Saturation Low	The current Oxygen Saturation has dropped below the O ₂ Alert Level set on the "Crit-Line" screen.	Low Alarm	Assess the patient for any changes in physiologic state. The alert can be cleared by setting the O₂ Alert Level button on the "Crit-Line" screen to OFF. <ul style="list-style-type: none"> To turn the O₂ Alert level OFF, select the O₂ Alert Level button, enter "0" (zero) on the keyboard, and press the CONFIRM key.
			 Note: At the direction of a physician, a new O ₂ Alert Level can be selected. To change the O ₂ Alert Level, select the O₂ Alert Level button, enter the desired value using the keyboard and press the CONFIRM key.
Patient Alarm	External alarm	High Alarm	Clear external alarm. If the problem persists, return the blood to the patient if alarm occurs during treatment. Take the machine and alert a qualified service technician.
Patient ID XXX	The PatientCard is inserted into the machine and the operator has reviewed the patient's information and continued on to the "Prescription" screen. The Patient ID is displayed here for reference.	Dialog Message	Verify the patient ID matches the patient, no other action required.
PatientCard not inserted! Continue without saving? Insert PatientCard and press CONFIRM to save data or press Escape to continue without saving	The PatientCard had been used to program the current treatment but is no longer inserted into the PatientCard Reader at the end of treatment when the PatientCard Reader is attempting to save the treatment data to the PatientCard.	Pop-Up	To save the treatment data to the PatientCard, insert the PatientCard into the PatientCard Reader slot on the IV pole mount. To continue without saving the treatment data, press the Escape key. The treatment data will need to be manually recorded.



Message	Purpose of Message	Type	Action Required
PHT is running	The PHT test must be completed before the OLC test is allowed to run.	Advisory	Wait 15 seconds and start the OLC test again.
Place venous bloodline in Venous Clamp! Unclamp venous pressure monitor line and connect it to the venous pressure port!	Auto Prime cannot continue because the venous bloodline is not in the Venous Clamp and/or the venous pressure monitor line is either clamped or not connected to the venous pressure port.	Pop-up	Make sure the venous bloodline is in the Venous Clamp and the venous pressure monitor line is unclamped and connected to the venous pressure port then press the CONFIRM key to continue.
Please wait, downloading from Medical Information System	The machine is attempting to download the prescription for the selected patient from the MIS.	Pop-up	Advisory only, no action required. This message will remain on the screen until the MIS is reached for a maximum of ten seconds, which ever comes first. To cancel contacting the MIS, press the Escape key.
Please wait, reading PatientCard	The machine is attempting to read the PatientCard.	Pop-up	Advisory only, no action required.
Please wait to test	The machine is preparing dialysate but the operator has attempted to run the Diasafe test.	Dialogue Box	Wait until the dialysate's temperature and conductivity are in range before running a Diasafe test.
Plug in Venous Pump	Single Needle option was initiated but the single-needle, blood pump is not plugged into the machine port.	Low Alarm	To proceed with the selected operation, install the single-needle blood pump into the machine.
PM Due Within:	The Preventive Maintenance Reminder in Service Mode was set and preventive maintenance is due in the number of hours or days listed, whichever comes first.	Advisory	No action required.
Power Failure Recovery	The machine is powering up after a power failure. Parameters have been recovered.	Opening Screen Message	Verify that all treatment settings are correct before resuming dialysis.
Power Logic Board Fail (during treatment)	The Power Logic Board microprocessor has stopped working and alarms are silent.	Low Alarm	Monitor the treatment relying on the Status Light and Status Box messages. After treatment, take the machine out of service and alert a qualified service technician.

Message	Purpose of Message	Type	Action Required
Power Logic Board Fail (at machine start up)	Communication with the Power Logic Board has failed.	Opening Screen Message	Turn machine power off and back on. If message is not cleared, take the machine out of service and alert a qualified service technician.
Prescription Verification, The following prescription parameters have changed: Press CONFIRM to use new prescription for this treatment or Press Escape to cancel changes to prescription	The PatientCard had been used to view the patient's prescription on the "Prescription" screen but the prescribed parameters have been changed. The parameters that have changed are listed in the pop-up window.	Pop-Up	To transfer the modified prescription to the dialysis screens for treatment, press the CONFIRM key. After the treatment using this modified prescription, the operator will be asked whether or not to save the modified prescription to the PatientCard (see "A modified Patient Prescription was used for this treatment" on page 206). To continue without using the modified prescription, press the Escape key. The prescription previously saved on the PatientCard will be used for treatment.
Press CONFIRM to exit	This message is a prompt for the operator to press the CONFIRM key to exit the Rinse program.	Advisory	To proceed with the selected operation, press CONFIRM .
Press CONFIRM to Load	This message is a prompt for the operator to press the CONFIRM key to load the heparin syringe.	Dialog Message	To proceed with the selected operation, press CONFIRM .
Press CONFIRM to Start	This message is a prompt for the operator to press the CONFIRM key to start the program.	Advisory	To proceed with the selected operation, press CONFIRM .
Press Confirm to switch to Blood Pressure graph. Press Escape to return to O2 graph	The operator has selected the O ₂ Sat graph field on the "Crit-Line" screen; the machine is prompting the operator to choose between displaying the BP graph or the O ₂ Sat graph.	Advisory message	Press the CONFIRM key to switch to the Blood Pressure graph. Or Press the Escape key to return to the Oxygen Saturation graph.
Press Confirm to switch to O2 graph. Press Escape to return to BP graph.	The operator has selected the BP graph field on the "Crit-Line" screen; the machine is prompting the operator to choose between displaying the O ₂ Sat graph or the BP graph.	Advisory message	Press the CONFIRM key to switch to the Oxygen Saturation graph. Or Press the Escape key to return to the Blood Pressure graph.
Press Done to exit	The Assisted Reinfusion program is finished running and the patient's blood has been returned.	Dialog Message	Select the Done button to exit the "Assisted Reinfusion" screen or, if the blood pump must run longer, press the Start/Stop key on the Blood Pump Module to run the blood pump longer.

Message	Purpose of Message	Type	Action Required
Press Done to transfer default prescription to dialysis screens	The New Tx key was pressed when the Service Mode 'Default Rx Screen' option was set and all default parameter values are displayed on this screen.	Dialog Message	The parameters may be edited directly from this screen before continuing. To transfer the parameters listed here to the dialysis screens, select the Done button. To exit this screen without setting the parameters to their defaults, press the Escape key.
Press ESCAPE to cancel rinse	This message is a prompt for the operator to press the Escape key to cancel the Rinse program.	Advisory	To proceed with the selected operation, press Escape then press CONFIRM .
Press ESCAPE To Stop [Item]	This message is a prompt for the operator to press the Escape key to stop loading the heparin syringe or the Rinse program.	Dialog Message	To proceed with the selected operation, press Escape then press CONFIRM .
Press Start button to run Auto Prime	The Prime key was pressed when the "Auto Prime" screen is displayed.	Dialog Message	To run the Auto Prime program, select the Start button on the "Auto Prime" screen.
Pressure Test Failed	The pressure test section (PHT) of the automated Test Sequence has failed.	High Alarm	Reset the alarm and repeat the test. If the failure message is repeated on retest, take the machine out of service and alert a qualified service technician.
PREVENTIVE MAINTENANCE DUE IN XX DAY(S) OR XX HOURS WHICHEVER OCCURS FIRST.	The Service Mode Preventive Maintenance Reminder has been set and scheduled maintenance must be performed before the date listed or hours remaining have elapsed. This message will appear until preventive maintenance has been performed and the Preventive Maintenance reminder in Service Mode has been reset.	Opening Screen Message	Advisory only, follow unit protocol.
Prime Complete	The Auto Prime program has finished priming the bloodlines. A beep notifies the user that the program is ready to proceed to recirculation.	Advisory	Continue the Auto Prime process by completing Steps 9 to 12 on Screen 2 of the Auto Prime program.
Priming	The operator has pressed the Prime key or selected the Auto Prime program and initiated the priming function.	Advisory	Advisory only. No action is required.

Message	Purpose of Message	Type	Action Required
Put Connectors in Port	The connectors must be in the machine ports in order to start a Rinse program.	Advisory	Connect the red (acid/acetate) and/or blue (bicarbonate) connectors to the appropriate rinse ports.
Put Lines On Shunt	An action has been initiated that requires the dialyzer supply and return lines to be on the shunt.	Low Alarm	To proceed with the selected operation, place dialyzer supply and return lines on the shunt.
Put Red Con in Chemical	This is a cleaning/disinfectant program prompt to the operator.	Advisory	Remove the red connector from the machine and place it into the wand in the yellow chemical/disinfectant bottle.
RAM Battery Failure	Electronic self-test failure.	High Alarm	Turn machine power off and back on. If the alarm is not cleared, take the machine out of service and alert a qualified service technician.
RAM Code Corrupted 1	Electronic self-test failure.	High Alarm	Turn machine power off and back on. If the alarm is not cleared, return the blood to the patient if alarm occurs during treatment. Take the machine out of service and alert a qualified service technician.
RAM Code Corrupted 2	Repeated electronic self-test failure.	High Alarm	Turn machine power off and back on. If the alarm is not cleared, return the blood to the patient if alarm occurs during treatment. Take the machine out of service and alert a qualified service technician.
Recirc Interrupted	The Recirculate program has been interrupted by an alarm condition. Or, during recirculation the UF Rate has exceeded the 'Max UF Rate' set in Service Mode; the UF pump has stopped.	Low Alarm	<ol style="list-style-type: none"> 1) Inspect the blood pump condition. Correct if required. 2) Reset the alarm and turn UF back on, if applicable. 3) If the alarm does not clear, take the machine out of service and alert a qualified service technician. <p>Note: If this alarm occurs during Auto Prime, increase the Service Mode Max UF Rate.</p>
Recirculating	Recirculation is in progress.	Advisory	Advisory only. No action is required.
Recirculating Done	A prompt to the operator that the recirculation process is done.	Advisory	Press Reset to clear the advisory message.
Recirculating Stopped	Recirculation has been stopped because blood is sensed or the dialyzer supply and return lines are on shunt.	Low Alarm	Inspect the configuration of the dialyzer supply and return lines and extracorporeal blood circuit. Correct any irregularities. If the message is not cleared, take the machine out of service and alert a qualified service technician.

Message	Purpose of Message	Type	Action Required
Recirculation in progress	Recirculation is running and the Low Volume button cannot be set to 'On'	Advisory	No action required, wait until recirculation has been completed before selecting the 'Low Volume' option if desired.
Reinfusion Timeout: Press Done to exit	The Assisted Reinfusion program has been returning blood for four minutes without sensing saline.	Dialog Message	Select the Done button to exit the "Assisted Reinfusion" screen or, if the blood pump must run longer, press the Start/Stop key on the Blood Pump Module to run the blood pump longer.
Release CONFIRM to stop	This message is a prompt for the operator to release the CONFIRM key to stop priming the heparin line.	Dialog Message	Release the CONFIRM key.
Rel. Blood Volume Low	<p>The BVM module has reported a relative blood volume below the lower limit.</p> <p>Or</p> <p>The current blood volume percentage or hematocrit has dropped below the BV Alert Level set on the "Crit-Line" screen. The UF pump has been turned off.</p>	Low Alarm	<p>Press Reset to clear the message if using the BVM (Blood Volume Monitor) module.</p> <p>Assess the patient for any changes in physiologic state.</p> <p>If using the CLiC device, the alert can be cleared by setting the BV Alert Level button on the "Crit-Line" screen to OFF.</p> <ul style="list-style-type: none"> To turn the BV Alert level OFF, select the BV Alert Level button, enter "0" (zero) on the keyboard, and press the CONFIRM key. After clearing the alert, the UF pump will automatically turn back on to the UF Rate set on the "Home" screen.
			<p> Note: At the direction of a physician, a new BV Alert Level can be selected. To change the BV Alert Level, select the BV Alert Level button, enter the desired value using the keyboard and press the CONFIRM key.</p>
Remove USB Device 1	A USB device has been plugged into the USB port on the right side of the display screen.	High Alarm	Remove the USB device.

Message	Purpose of Message	Type	Action Required
Remove USB Device 2	A powered USB device has been plugged into the USB port on the back of the machine.	High Alarm	<p>Remove the USB device. Turn machine power off and back on. If alarm is not cleared, return the blood to the patient if alarm occurs during treatment. Take the machine out of service and alert a qualified service technician.</p> <p>If the mitigation noted above is unsuccessful and the alarm persists, follow the steps listed below in the correct order:</p> <ol style="list-style-type: none"> 1. Update Functional board software to version 2.74 or higher. This software corrects a software anomaly that can generate a false alarm. If this step does not correct the false alarm, proceed to step 2. 2. Connect a passive device (load) on USB Port 2 that will continually draw current, such as a blank USB memory stick or RFID card reader. EMI noise affecting systems equipped with CDX can induce a false "Remove USB Device 2" alarm.
Reset to adjust TMP	The TMP exceeded the hard alarm limits. The operator is given the option to relieve the pressure to bring the TMP within limits.	Low Alarm	Press the Reset key to reset the TMP alarm limits. Press and hold the Reset key to re-center the limits.
	 Warning! Adjusting the TMP repeatedly will decrease the UF removed from the patient.		 Warning! Rising TMP may indicate a leak in the balancing system and should be investigated.
Reset Treatment? CONFIRM or Escape	The New Tx key has been pressed	Advisory	To erase the current treatment information and move it to the "Trends" screen when initiating a new treatment, press CONFIRM . To cancel, press Escape .
Resetting, Try Again.	Blood pressure module resetting	Low Alarm	Wait until blood pressure module completes resetting and retry blood pressure reading.
Retry > Press = XXX	The cuff pressure is too low to measure the blood pressure. The cuff pressure is XXX mmHg.	Dialog Message	No action necessary

Message	Purpose of Message	Type	Action Required
Returning Blood	The patient's blood is being returned using the Assisted Reinfusion program. The blood pump will continue to run for ten seconds after the optical detector no longer senses blood or two minutes, whichever comes first.	Advisory	Monitor the returning of the patient's blood and disconnect the patient when prompted. To cancel the Assisted Reinfusion program and manually return the blood, press the Escape key.
Reverse bloodlines	This message is a prompt for the operator reverse the bloodlines for the Access Flow test	Low Alarm	To proceed with the Access Flow test, reverse the bloodlines and press CONFIRM .
Rinse Cond High	The Reverse Osmosis (RO) water inlet conductivity is too high.	Opening Screen Message	Press the Reset key to clear the message. Perform a Rinse cycle. If alarm is not cleared, take the machine out of service and alert a qualified service technician.
Rinse Interrupted	A rinse was running but was interrupted before it could be completed.	Opening Screen Message	Run a rinse program.
Rinse Times Not Calibrated	Rinse settings have been lost or not set.	Opening Screen Message	Turn machine power off and back on. If alarm is not cleared, take the machine out of service and alert a qualified service technician that rinse times must be programmed.
RO Water Cond High	The Reverse Osmosis (RO) water inlet conductivity is too high.	Opening Screen Message	Press the Reset key to clear the message. Perform a Rinse cycle. If alarm is not cleared, take the machine out of service and alert a qualified service technician.
RTD = Zero	The RTD (Remaining Time on Dialysis) clock has counted down to zero.	Low Alarm	Reset the alarm. This message has alerted the operator that the preset time on dialysis has elapsed (RTD = 0:00). If prescribed treatment time has not been completed, the operator must take further action to comply with the prescribed treatment.
Running Diasafe Test	This message is advising the operator of the status of the Diasafe test	Advisory	Advisory only. No action is required.
Running Online PHT	This message is displayed when the online Pressure Holding Test is in progress.	Advisory	Advisory only. No action is required.
Run Access Flow?	This message is a prompt for the operator begin the Access Flow test.	Low Alarm	To proceed now, press CONFIRM . To delay, press Escape . To cancel, go to the "Kt/V AF" screen and toggle the Access Flow check box to Off.

Message	Purpose of Message	Type	Action Required
S/N: N/A	The serial number cannot be displayed on the "Select Program" screen because the EEPROM has not been installed.	Advisory	Alert a qualified service technician and follow unit protocol.
S/N: Not Entered	The serial number cannot be displayed on the "Select Program" screen because it was not entered in Service Mode.	Advisory	Alert a qualified service technician and follow unit protocol.
Saving to PatientCard	Information is being saved to the PatientCard.	Pop-up	Advisory only, no action is required. Do not remove the PatientCard until this message has cleared.
Select Concentrate	This message is a prompt for the operator to select a concentrate.	Advisory	To select a concentrate from the menu, use the ↑ or ↓ (Up/Down) keys on the keyboard to highlight the desired concentrate, and press CONFIRM . For more information, see Chapter 3, "Setting an Acid/Bicarbonate Type."
Select Dialysis before inserting PatientCard	The PatientCard was inserted into the PatientCard reader while on the "Select Program" screen	Dialog Message	Advisory only. To view the information on the inserted PatientCard, first select the Dialysis button then insert the PatientCard.
Select new goal or rate	UF time is out of range.	Dialog Message	Enter a new UF Goal or reduce UF time.
Select new Goal or Time	UF rate is out of range.	Dialog Message	Enter a new UF Goal or reduce UF rate.
Select Program	This message is a prompt for the operator to select a program.	Advisory	To proceed, select the desired program and press CONFIRM .
Set Arterial Chamber to Pre	The operator has attempted to set the Auto Prime or Assisted Reinfusion options but the Arterial Chamber setting on the "Hardware Options" screen is in conflict.	Advisory	To enable the 'Auto Prime' or 'Assisted Reinfusion' options, first set the 'Arterial Chamber' option to 'Pre' and ensure the module arrangement is in the Pre-pump arterial chamber configuration (see Figure 26).
Set Arterial Limits	This is a message to re-center the arterial limits if necessary	Advisory	Press and hold Reset for 1 second to re-center the limits.
Set Blood Flow to 300	This message is a prompt for the operator to set the blood flow rate in preparation for the Access Flow test	Low Alarm	To proceed, set Blood Flow to 300 and press CONFIRM .

Message	Purpose of Message	Type	Action Required
Set TMP Limits?	This is a message to re-center the TMP limits if necessary	Advisory	Rising TMP may indicate a leak in the balancing system and should be investigated. Press and hold Reset for 1 second to re-center the limits.
Set Venous Limits	This is a message to adjust the venous limits if necessary	Advisory	Press and hold Reset for 1 second to adjust the limits. Changes in venous pressure during the treatment should be investigated. See "Ven. Pressure Alarm"
Short Power Down	The machine was switched off for one minute and turned back on. Setup values have not been set to default values.	Advisory	Verify that the dialysis parameters are as desired.
Single Needle On!	An action has been initiated that requires the Single Needle option to be off.	Low Alarm	To proceed with the selected operation, de-select the Single Needle option.
SLED Complete	The machine has reached the maximum time allowed for a SLED treatment. UF and dialysate flow have been turned off. The extracorporeal blood circuit must be replaced and the machine must be powered down before running another treatment.	Low Alarm	Follow facility protocol to end the treatment.
SLED Disabled: Diasafe Filter Not Set!	SLED requires that the Diasafe Filter Service Mode option is set to 'Yes'	Advisory	To run a SLED treatment: Take the machine out of service and alert a qualified service technician before continuing. Or, if SLED is not desired, select the Dialysis button to run a dialysis treatment.
SLED Paused	In SLED, the Tx clock is paused.	Advisory	No action is required.
Slow Flow Uncalibrated	The temperature calibration has not been performed; dialysate flow rates of 100, 150, and 200 ml/min are not available.	Advisory	To run a SLED treatment: Take the machine out of service and alert a qualified service technician before continuing. Or, if SLED is not desired, select the Dialysis button to run a dialysis treatment using a dialysate flow of at least 300 ml/min.
SN BP +5 V Error	+ 5 volts is outside the allowable range	High Alarm	See message E.10
SN BP +12 V Error	+ 12 volts is outside the allowable range	High Alarm	See message E.07

Message	Purpose of Message	Type	Action Required
SN BP -12 V Error	- 12 volts is outside the allowable range	High Alarm	See message E.09
SN BP +24 V Error	+ 24 volts is outside the allowable range	High Alarm	See message E.08
SN BP Button Alarm	Key stuck or held in too long	High Alarm	See message A.16
SN BP Comm. Timeout	Time out when receiving Intel-Hex-line or overflowed received buffer	High Alarm	See message A.27
SN BP Del. Rate Alarm	Actual speed-read back analog voltage at X348/10 is out of limits	High Alarm	See message A.21
SN BP Direction Alarm	Pump is turning in the wrong direction	High Alarm	See message A.13
SN BP EEPROM Error	EEPROM error	High Alarm	See message E.05
SN BP EPROM Error	EPROM CRC error	High Alarm	See message E.01
SN BP Erasing Error	Error erasing Flash ROM while in Service Mode	High Alarm	See message E.98
SN BP Flash Error	Error copying data into Flash ROM while in Service Mode	High Alarm	See message E.97
SN BP Level Up Alarm	Pressure increase when the Level Up key is pressed	High Alarm	See message A.25
SN BP Pressure Alarm	Arterial pressure-read back analog voltage at X348/7 is out of limits SN pressure-read back analog voltage is out of limits	High Alarm	See message A.22
SN BP RAM Error	RAM check error	High Alarm	See message E.03
SN BP Rate Alarm	Pump is not reaching speed at maximum voltage	High Alarm	See message A.11
SN BP Receiving Alarm	Error in received Intel-Hex-line	High Alarm	See message A.28
SN BP ROM Error	Flash ROM CRC error	High Alarm	See message E.02

Message	Purpose of Message	Type	Action Required
SN BP Rotation Error	Pump rotor turning when it should not be for a second time	High Alarm	See message E.23
SN BP Set Rate Alarm	Set speed-read back analog voltage at X348/14 is out of limits	High Alarm	See message A.20
SN BP Stop Alarm	Pump rotor turning when it should not be	High Alarm	See message A.29
SN BP Tach Alarm	Optical tachometer not in range	High Alarm	See message A.24
SN BP Task Error	Software task was not completed correctly	High Alarm	See message E.15
SN BP Timer Error	50 ms second time period exceeded	High Alarm	See message E.14
SN BP Update Error	Transmit error during Flash update while in Service Mode	High Alarm	See message E.99
SN BP Volt Error	Reference Voltage error	High Alarm	See message E.04
SN BP WD Error	Watchdog timeout	High Alarm	See message E.06
SN pump in use	The OLC test may not be run when the Single Needle system is in use.	Advisory	Do not attempt an OLC test when using Single Needle
Stabilizing Dialysate	The machine is preparing the concentrates for the dialysate.	Advisory	No action required. This message will be displayed for four minutes or until conductivity is within range, whichever comes first. Self-tests are unavailable until this message clears.
Standby for Test	This message is displayed before the start of the Alarms and Pressure test	Advisory	Advisory only. No action is required.
Start Na+ greater than max. value	Entered Start Na+ parameter is larger than allowed.	Advisory	The Starting Na+ will be set to the highest allowed Na+ level. Press CONFIRM to clear message and accept the maximum allowed value. Verify that the value is acceptable or enter new value.
Start Na+ less than minimum value	Entered Start Na+ parameter is less than allowed.	Advisory	The Starting Na+ will be set to the lowest allowed Na+ level. Press CONFIRM to clear message and accept the minimum allowed value. Verify that the value is acceptable or enter new value.

Message	Purpose of Message	Type	Action Required
Super I/O no comm	Hardware related error message	Opening Screen Message	This will only affect the use of the Single Needle pump system. If necessary, turn off the machine and try again. If the message is not cleared, alert a qualified service technician.
Switch bloodlines back	This message is a prompt for the operator return the bloodlines to their original position	Low Alarm	To proceed, press CONFIRM .
SVS Is On!	An action has been initiated that requires the SVS to be off.	Low Alarm	To proceed, turn the SVS option off by selecting the None profile and pressing the CONFIRM key on the touchpad.
SVS not stable	An OLC test was attempted when SVS was in conductivity tracking mode.	Advisory	Wait until the SVS limit tracking phase is complete (maximum of 7 minutes) and initiate an OLC test.
SVS Option disabled in Service Mode	The Sodium Variation System (SVS) Service Mode option has been set to 'No' when SVS was prescribed.	Pop-up	Press the CONFIRM key to continue. SVS profiles will not be available for treatment until the Service Mode 'SVS' option has been set to 'Yes'.
SVS-Time longer than RTD	The SVS time is set for a longer period than the treatment time, RTD, which is unexpected	Dialog Message	Press CONFIRM or Escape . Verify that the RTD and SVS time are set correctly.
System Leak, Can't Run	A leak was detected in the Heat Exchanger or in the tubing/components connected to the Heat Exchanger during the Chemical/Rinse program.	Low Alarm	Exit the Chemical/Rinse program and return to the "Select Program" screen. Retry the Chemical/Rinse program. If the alarm message is still not cleared, call a qualified service technician.
			 Note: This message means that the Chemical/Rinse program can no longer be run due to a leak detected in the Heat Exchanger. However, the machine will still be able to run Heat Disinfection programs and hemodialysis treatments per unit protocol.
Take Lines Off Shunt	An action has been initiated that requires the dialyzer supply and return lines to be off the shunt.	Low Alarm	To proceed with the selected operation, dialyzer supply and return lines must be off the shunt. Connect lines to the dialyzer.
Target Kt/V has been set to min.	The operator has attempted to set the Target Kt/V to less than the minimum allowed.	Dialog Message	The machine has set the target Kt/V to the lowest allowed target. Verify that the value is acceptable.

Message	Purpose of Message	Type	Action Required
Temp DAC Error	The DAC (Digital/Analog conversion) for the temperature trim function is outside of its limits.	Low Alarm	Press Reset key to reset alarm The temperature trim function will be disabled until the temperature sensors are recalibrated.
Temp Over 95 Degrees	Electronic self-test failure.	High Alarm	Turn machine power off and back on. If alarm is not cleared, return the blood to the patient if alarm occurs during treatment. Take the machine out of service and alert a qualified service technician.
Temp Sensors unmatched	When the temperature trim function needs to change DAC by > 1° C, the pre and post sensors are verified against one another. This message occurs if the two temperature sensors are more than 0.5° C different.	Low Alarm	Press Reset key to reset alarm The temperature trim function will be disabled until the machine is turned off and back on.
Temp Control not calibrated	This message is displayed on the sign on screen if the temperature sensors were not matched when they were verified against one another.	Advisory	Calibrate the temperature control.
Temperature control not calibrated	Temperature control calibration has been lost or not set.	High Alarm	Turn machine power off and back on. If alarm is not cleared, take the machine out of service and alert a qualified service technician that temperature control calibration is needed.
Temperature greater than max. value	Entered Temperature value is higher than allowed.	Dialog Message	The temperature will be set to the highest allowed level. Press CONFIRM to clear message and accept the maximum allowed value. Verify that the value is acceptable or enter new value.
Temperature has been set to min.	The operator has attempted to set a Temperature lower than allowed.	Dialog Message	The temperature will be set to the lowest allowed level.
Temperature not calibrated	Temperature calibration has been lost or not set.	High Alarm	Turn machine power off and back on. If alarm is not cleared, take the machine out of service and alert a qualified service technician that temperature calibration is needed.
Test Complete	All selected self-tests passed.	Advisory	Advisory only. No action required.
Test Failed	The Alarm and/or PHT Sections of the automated Test Sequence have failed	High Alarm	Reset the alarm. Check the setup to see if the alarm can be corrected and then retest. If the machine fails, turn machine power Off and back On. If alarm is still not cleared, take the machine out of service and alert a qualified service technician.

Message	Purpose of Message	Type	Action Required
Test: Independent Cond	The Independent Conductivity self-test is running	Test Message	Advisory only. No action is required.
Testing temp sensor	In rare cases, the machine may be put into bypass to verify the temperature sensor. The OLC test cannot be run at this time.	Advisory	Wait 10 minutes and start the OLC test again.
TMP is High (toward 500)	The TMP has exceeded the TMP high alarm limit value.	High Alarm (Blood)	<ol style="list-style-type: none"> 1) Check the dialyzer supply and return lines for kinks and that the connectors are properly connected to the dialyzer or the shunt. 2) Clean the dialysate line filter screen. 3) Press Reset key to reset alarm. Press the Reset key and hold for two seconds to select new alarm limits or for adjusting the TMP. If unable to reset the alarm, call your local qualified service technician. <p>High UF Goal and low dialyzer KUF coefficient can exceed the maximum TMP of 520 mmHg. The UF Goal may need to be lowered. This in turn will lower the UF rate and the TMP. Notify a physician if the UF Goal has changed.</p>
	 <p>Warning! A rising TMP may indicate a leak in the balancing system and should be investigated.</p>		

Message	Purpose of Message	Type	Action Required
TMP is Low (alarm at or below 60)	The TMP has exceeded the TMP low alarm limit value.	High Alarm (Blood)	<ol style="list-style-type: none"> 1) Ensure that the venous transducer protector is dry and the monitor line is open. Replace the transducer protector, if necessary. 2) Check the dialyzer supply and return lines for kinks. 3) Check the filter screen in the dialyzer return line to make sure it is clean. 4) Press Reset key to reset alarm. Press the Reset key and hold for two seconds to select new alarm limits or for adjusting the TMP.
			 <p>Note: Increasing the UF rate can also raise the TMP. Administer saline as prescribed. Notify a physician if the UF rate has changed.</p>
			<p>Note: Lowering the venous pressure by reducing the blood flow rate can also be effective, if using a high-permeable dialyzer. Notify a physician if the blood flow rate has changed.</p>
5) If unable to reset the alarm, return the blood to the patient if alarm occurs during treatment. Take the machine out of service and alert a qualified service technician.			
To exit, press ESCAPE	A process is running that the operator may exit by pressing the Escape key.	Dialog Message	Advisory only. No action is required.
To run Auto Prime:	Auto Prime cannot continue because of any number of the error conditions listed in the pop-up.	Pop-up	Make sure the conditions listed in the pop-up are corrected then press the CONFIRM key to continue.
Tx Clock On	The operator has selected the Empty bibag button when the Tx Clock is running. The bag cannot be emptied using the Empty bibag button when the Tx Clock is running.	Dialog Message	If the treatment is not yet completed and the <i>bibag</i> disposable must be changed, lift up on the <i>bibag</i> door, wait 30 seconds to relieve the pressure, and remove the bag. Put a new <i>bibag</i> disposable on the connector and close the door again to continue using the <i>bibag</i> system for the treatment.
Tx Clock Paused?	Blood is sensed in optical detector while Tx clock is paused.	Low Alarm	Start Tx clock

Message	Purpose of Message	Type	Action Required
UF Goal greater than max. value	Entry value for goal is out of range.	Dialog Message	Readjust UF Goal
UF Goal Reached	This message is to alert the operator that the preset ultrafiltration goal has been reached.	Low Alarm	Press Reset to reset the alarm. The preset UF Goal has been reached and the UF Rate will drop to the minimum UF Rate. If the patient's prescribed UF Goal has not been reached, the operator must take further action to comply with the prescribed treatment.
UF Is On	An action has been initiated that requires the UF to be off.	Advisory	To proceed with the selected operation, turn the UF pump off.
UF Profile Error	A UF profile calculation error has been detected.	High Alarm	Reset the UF parameters
UF Pump Alarm	UF pump is not connected or is not pulsing properly.	High Alarm	Press Reset to reset the alarm. If unable to clear the alarm, return the blood to the patient if alarm occurs during treatment. Take machine out of service and alert a qualified service technician.
UF Pump Off	The UF pump has been off for ten minutes.	Low Alarm	To continue with the UF pump off, press Reset to clear the message. This message will not be displayed again. If you intend for the UF pump to be on, press the UF on/off key on the control panel. The light above the key will be illuminated.
UF pump volume not calibrated	UF pump volume calibration has been lost or not set.	High Alarm	Turn machine power off and back on. If alarm is not cleared, take the machine out of service and alert a qualified service technician that UF pump volume calibration is needed.
UF Rate Error	A calculation error has been detected	High Alarm	Reset the UF parameters
UF Removed cleared	This temporary message is displayed when the Tx clock is turned on the first time after the New Tx key was pressed. The UF removed has been set to 0.	Advisory	No action necessary.
UF Removed not cleared	This temporary message is displayed when the Tx clock is turned on other than the first time after the New Tx key was pressed. The UF removed has been <u>not</u> been set to 0.	Advisory	No action necessary.

Message	Purpose of Message	Type	Action Required
Unclamp arterial and venous pressure monitor lines and connect them to the pressure ports!	Auto Prime cannot continue because the arterial and/or venous pressure monitor lines are either clamped or not connected to their pressure ports.	Pop-up	Make sure the arterial and venous pressure monitor lines are unclamped and connected to their pressure ports then press the CONFIRM key to continue. This message may also appear if the transducer protectors have become wet. If so, clear the pressure monitor line with a sterile syringe and replace the transducer protector with a new, sterile transducer protector.
Unmatched Serial Numbers!	The serial number saved in Battery RAM does not match the serial number saved on the Functional board or Motherboard EEPROMs.	Opening Screen Message	Turn machine power off and back on. If message is not cleared, take the machine out of service and alert a qualified service technician.
Upper Dia. has been set to Min [Max]	The operator has attempted to set the upper diastolic pressure limit higher or lower than allowed. The machine has set the limit to the highest or lowest value allowed.	Dialog Message	Verify that the limit setting is acceptable
Upper Pulse has been set to Min [Max]	The operator has attempted to set the upper pulse rate limit higher or lower than allowed.	Dialog Message	The machine has set the limit to the highest or lowest value allowed. Verify that the limit setting is acceptable
Upper Sys. has been set to Min [Max]	The operator has attempted to set the upper systolic pressure limit higher or lower than allowed.	Dialog Message	The machine has set the limit to the highest or lowest value allowed. Verify that the limit setting is acceptable
USB drive may be removed	The disinfection log transfer to a USB drive is complete.	Dialog Message	The USB drive may be removed. To exit the "Disinfection Log" screen, press the Escape key.
Use external knob to adjust	The alarm volume cannot be adjusted using the touchscreen.	Advisory	Use the external volume knob on the back of the machine to adjust the alarm volume.
V104 Stuck Open	Bicarbonate concentrate port valve error. The machine is in bypass mode.	High Alarm (Water)	Turn machine power off and back on. If alarm is not cleared, return the blood to the patient if alarm occurs during treatment. Take the machine out of service and alert a qualified service technician.

Message	Purpose of Message	Type	Action Required
V104/108 Stuck Closed	Bicarbonate concentrate port valve error or rinse port valve error. The machine is in bypass mode.	High Alarm (Water)	<p>Check for a kinked bicarbonate concentrate supply line.</p> <p>Make sure that the bicarbonate concentrate connector is firmly connected. If the bicarbonate concentrate source is a central feed system, make sure that the line is open.</p> <p>If the error occurs during a rinse, open the <i>bi</i>bag door for at least five seconds (with no <i>bi</i>bag attached). Rerun the rinse program.</p> <p>If alarm is not cleared, turn machine power off and back on. If alarm is still not cleared, return the blood to the patient if alarm occurs during treatment. Take the machine out of service and alert a qualified service technician.</p> <p> Note: If this error occurs upon power up or after any of the cleaning/disinfecting programs, make sure the blue bicarbonate connector is firmly plugged into the bicarbonate port then run the cleaning/disinfecting program again. If the alarm is not cleared, turn the machine off and back on and run a Rinse program. If the alarm is still not cleared, take the machine out of service and alert a qualified service technician.</p>
V105 Stuck Open	Acid concentrate port valve error. The machine is in bypass mode.	High Alarm (Water)	Turn machine power off and back on. If alarm is not cleared, return the blood to the patient if alarm occurs during treatment. Take the machine out of service and alert a qualified service technician.

Message	Purpose of Message	Type	Action Required
V105 Stuck Closed	The acid concentrate supply line is not pulling in acid concentrate. The machine is in bypass mode.	High Alarm (Water)	<p>Check for a kinked acid concentrate supply line.</p> <p>Make sure that the acid concentrate connector is firmly connected. If the acid concentrate source is a central feed system, make sure that the line is open.</p> <p>If alarm is not cleared, turn machine power off and back on. If alarm is still not cleared, return the blood to the patient if alarm occurs during treatment. Take the machine out of service and alert a qualified service technician.</p> <p> Note: If this error occurs upon power up or after any of the cleaning/disinfecting programs, make sure the red acid connector is firmly plugged into the acid port then run the cleaning/disinfecting program again.</p>
Value not set to Nominal value of XXX Press CONFIRM to continue	The 'New Tx Rx Warn' Service Mode option has been set and the Bicarbonate value is not at the nominal 33 mEq/L for NaturaLyte/GranuFlo brand concentrates or 34 mEq/L for Citrasate brand concentrates.	Pop-Up	Verify that the Base Na ⁺ and/or Bicarbonate settings on the "Dialysate" screen match the patient's prescription. Press the CONFIRM key to continue.
Values displayed in red are out of range, choose new values. Press CONFIRM to continue	The prescription from the Medical Information System (MIS) is out of the allowable settings range on the 2008T hemodialysis machine.	Pop-Up	Press the CONFIRM key to close the pop-up message then review the "Prescription" screen's settings for any values displayed in red, meaning that they are out of range. Select the parameter-button or screen-button associated with the out of range value and set it within in the allowable limits for the 2008T hemodialysis machine to continue.
Valve 43 Failure	Valve 43 has remained open too long	High Alarm	Turn machine power off and back on. Just before beginning dialysis, verify that the dialysate flow can be turned off and back on. Do not initiate or continue dialysis if this cannot be done.
Valve 104 Err	Bicarbonate concentrate port valve error. The machine is in bypass mode.	High Alarm (Water)	Turn machine power off and back on. If the alarm is not cleared, return the blood to the patient if alarm occurs during treatment. Take the machine out of service and alert a qualified service technician.

Message	Purpose of Message	Type	Action Required
Valve 105 Err	Acid concentrate port valve error. The machine is in bypass mode.	High Alarm (Water)	Turn machine power off and back on. If the alarm is not cleared, return the blood to the patient if alarm occurs during treatment. Take the machine out of service and alert a qualified service technician.
Variable Temperature	The temperature fluctuates between High Temperature and Low Temperature.	High Alarm (Dialysate)	<ol style="list-style-type: none"> 1) Ensure that water to the machine is turned on. 2) Check the Temperature value in the "Home" screen. Re-enter it if necessary and allow five minutes for the temperature to stabilize. <p>If unable to attain the prescribed temperature discontinue treatment and alert a qualified service technician.</p>
			 <p>Caution: Do not use the Heat Disinfect cycle until the machine is repaired. If you are unable to attain proper dialysate temperature, return the blood to the patient if the alarm occurs during treatment. Take the machine out of service and alert a qualified service technician.</p>
Ven. Pressure Alarm (with the upper Venous Pressure Alarm limit flashing)	High pressure detected in the venous drip chamber.	High Alarm (Blood)	<ol style="list-style-type: none"> 1) Check venous tubing for kinks, clotting, or closed clamps. 2) Ensure that the transducer protector is dry and the monitor line is open. Replace the transducer protector, if necessary. 3) Check access point for clotting and needle position. 4) Press Reset to reset alarm. Press the Reset key again and hold for two seconds to select new alarm limits. If alarm won't reset, return the blood to the patient if alarm occurs during treatment. Take the machine out of service and alert a qualified service technician.

Message	Purpose of Message	Type	Action Required
Ven. Pressure Alarm (with the lower Venous Pressure Alarm limit flashing)	Low pressure detected in the venous drip chamber.	High Alarm (Blood)	1) Check venous tubing for disconnected line.
			 Note: A low venous pressure alarm may not occur with every disconnection or needle dislodgment. Machine alarms may not occur in every blood loss situation.
			2) Ensure that the transducer protector is dry and the monitor line is open. Replace the transducer protector, if necessary. 3) Press Reset to reset alarm. Press the Reset key again and hold for two seconds to select new alarm limits. If you are unable to reset the alarm, return the blood to the patient if alarm occurs during treatment. Take the machine out of service and alert a qualified service technician.
Venous Pressure not calibrated	Venous pressure calibration has been lost or not set.	High Alarm	Turn machine power off and back on. If alarm is not cleared, take the machine out of service and alert a qualified service technician that venous calibration is needed.
Venous pump rate not calibrated	Venous pump rate calibration has been lost or not set.	High Alarm	Turn machine power off and back on. If alarm is not cleared, take the machine out of service and alert a qualified service technician that venous pump rate calibration is needed.
Verify Failed	The verification test shows that the CLiC device is not ready for use during treatment.	Advisory message	Verify the CLiC device: <ul style="list-style-type: none"> Place the CLiC device on the CLiC Verification Filter, which is attached to its USB cable. Wait up to one minute for the message to clear. If the message clears, the CLiC device is verified. If the message is not cleared: <ul style="list-style-type: none"> Select the “Test & Options” screen-button then select the Verify Crit-Line button. This will start the verification process manually. Wait up to one minute for the message to clear. If the message is still not cleared, the CLiC device cannot be used for the dialysis treatment. <ul style="list-style-type: none"> Disconnect the CLiC device cable from the USB port. Press the Reset key to disable the CLiC device. Contact a qualified service technician.

Message	Purpose of Message	Type	Action Required
Verifying temp sensors	The machine will go into bypass for about 8 minutes while the temperature sensors are verified. RTD will pause.	Advisory	Advisory only. No action is required
Voltage limits not calibrated	Voltage limits calibration has been lost or not set.	High Alarm	Turn machine power off and back on. If alarm is not cleared, take the machine out of service and alert a qualified service technician that voltage limits calibration is needed.
Wait, OLC Aborting	Changed blood pump flow rate, changed dialysate flow rate, or unstable conductivity caused on line clearance test to stop.	Advisory	Wait until stable conditions for OLC test to begin again
Wait: Rinsing Line	The machine is rinsing the concentrate lines prior to a cleaning or disinfecting program.	Advisory	Advisory only. No action is required. Line rinsing takes about 45 seconds.
Water Prerinse	The machine is running a water rinse before a cleaning or disinfecting program.	Advisory	Advisory only. No action is required. Line rinsing duration is displayed as 'Remaining Prerinse Time'.
WD: 24v Rcvr Err Long	Electronic self-test failure.	High Alarm	Turn machine power off and back on. If the alarm is not cleared, take the machine out of service and alert a qualified service technician.
WD: 24v Rcvr Err Short	Electronic self-test failure.	High Alarm	Turn machine power off and back on. If the alarm is not cleared, take the machine out of service and alert a qualified service technician.
WD: Fail Long Pulse	Electronic self-test failure.	High Alarm	Turn machine power off and back on. If the alarm is not cleared, take the machine out of service and alert a qualified service technician.
WD: Fail Short Pulse	Electronic self-test failure.	High Alarm	Turn machine power off and back on. If the alarm is not cleared, take the machine out of service and alert a qualified service technician.
Wrong PatientCard inserted! Insert correct PatientCard and press CONFIRM to continue or Press Escape to cancel saving to PatientCard	A PatientCard with an ID saved to it was used to program the treatment but now a different PatientCard is inserted into the PatientCard Reader slot.	Pop-Up	Either insert the correct PatientCard and press the CONFIRM key to continue Or Press the Escape key to cancel saving to any PatientCard. The information will also not be saved to the Medical Information System (if applicable).

Replacing the DIASAFE *plus*_{US} Filter

The DIASAFE *plus*_{US} filter is intended for the preparation of ultra-pure dialysate. If the machine has a DIASAFE *plus*_{US} filter, it should be replaced at least every 90 days. You must also replace the filter if the Diasafe test fails or shows an external leak. To replace the DIASAFE *plus*_{US} filter:



Warning! The use of the DIASAFE *plus*_{US} filter does not reduce the need for routine disinfection of your machine and RO system or routine monitoring of the chemical and bacterial water quality. The disinfection procedure is unchanged with the DIASAFE *plus*_{US} filter installed.

Warning! The DIASAFE *plus*_{US} filter can only be used in hemodialysis machines fitted with DIAFIX™ Lock System kits.

1. Turn off the hemodialysis machine and then remove the clear protective cover from the DIAFIX Lock System on the back of the machine.
 2. Lift up the lock levers on the left side of the filter mount and slide used DIASAFE *plus*_{US} filter up and out. Follow your clinic's instructions for disposal.
 3. Refer to the illustration on the next page: Remove the plastic tabs from a new DIASAFE *plus*_{US} filter.
-



Caution: Be sure to remove the plastic tabs on the DIASAFE *plus*_{US} filter inlet and outlet before inserting the new filter in the machine.

4. Fit the new DIASAFE *plus*_{US} filter in the two grooves at the top and bottom of the mount and slide it down until it clicks into place.
5. Push the lock levers down again to lock the filter into the DIAFIX Lock System.
6. Place the orange product installation date label on the filter.
7. Reinstall the clear protective cover.
8. Power on the 2008T hemodialysis machine and test the new DIASAFE *plus*_{US} filter: From the “Test & Options” screen (see page 112), select the **Pressure Test** button and press **CONFIRM** to start the test. When the Pressure Holding test has passed, select the **Diasafe Test** button and press **CONFIRM** to start the test.

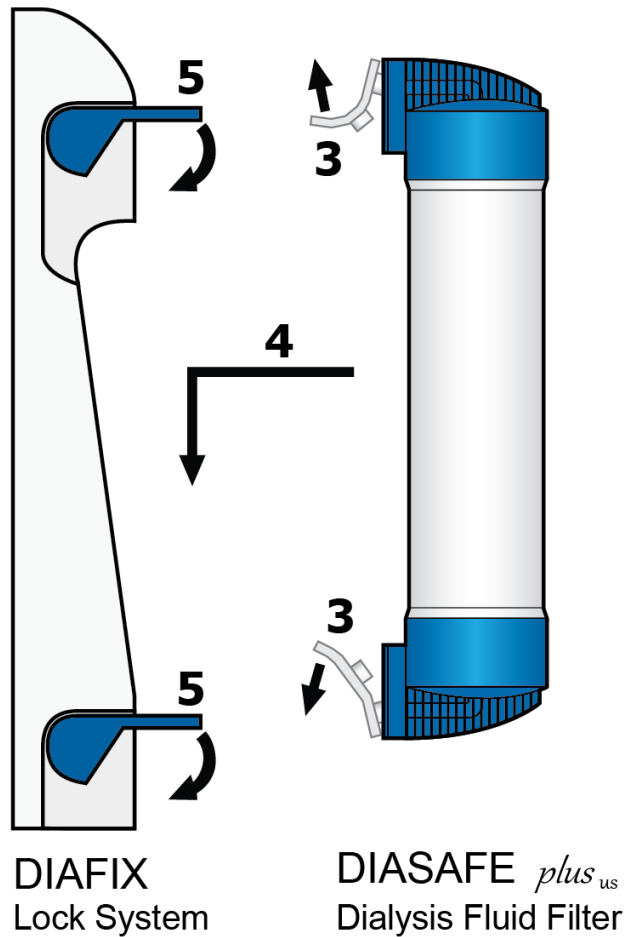

Figure 100 – Installing a new DIASAFE *plus_{US}* filter



Warning! The pressure test must be performed after installing a new DIASAFE *plus_{US}* filter. If the machine fails any of the tests and the cause cannot be corrected, or if it fails later tests, it should not be used for treatment. Have the machine checked by a qualified technician to correct the problem.

Warning! After installation of a new DIASAFE *plus_{US}* filter, run a Heat Disinfect or Chemical/Rinse program to disinfect the machine.

Replacing the 9-Volt Battery

Replace the machine’s 9-Volt battery if the battery test fails in the Alarm test. Follow the instructions below:

1. Turn the machine OFF. Locate the battery on the back of the machine and push the black battery loading cartridge in and to the left. The battery cartridge will pop forward. Slide the cartridge out.
2. Power the machine ON and run the Alarm test on the “Test & Options” screen (see page 72). The machine should fail the battery test. If it passes the test, call a qualified technician.

- Place a fresh battery in the cartridge and reinsert it back into the machine as shown in Figure 101. The negative side of the 9-Volt battery should be on top.



Warning! Do not install the 9-Volt battery backwards in the machine, as it will damage the “No Power” alarm.

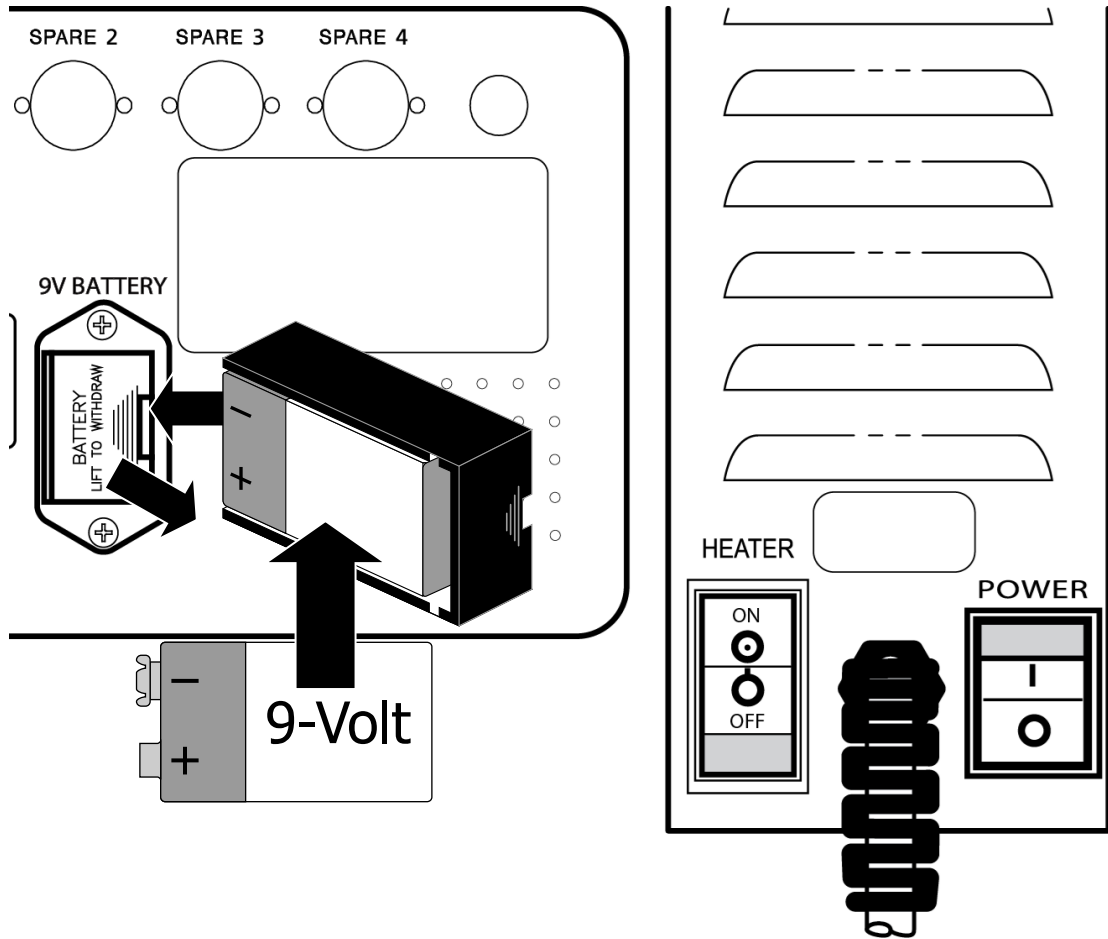

Figure 101 – Replacing the 9-Volt Battery

- Power the machine ON and, using the mains power switch on the back of the machine (see the right side of Figure 101), shut off the power to the machine. Listen for the No Power alarm, if the alarm does not sound, repeat steps 1-4.



Warning! If the machine fails these tests and the cause cannot be corrected, it should not be used for treatment. Have the machine checked by a qualified technician to correct the problem.



Note: Periodically check the power cord for damage (fraying, over-heating, cuts, scrapes, etc.)

Note: The normal service life of the battery is one year. If Auto Heat Disinfect, Auto Start or CDX Auto On are enabled on the Scheduler, and no power is supplied to the machine, the battery life will be a maximum of 336 hours (14 days). The 336 hours is cumulative and may be reached with any combination of hours that the machine is unplugged.

Single Needle Dialysis (Optional)

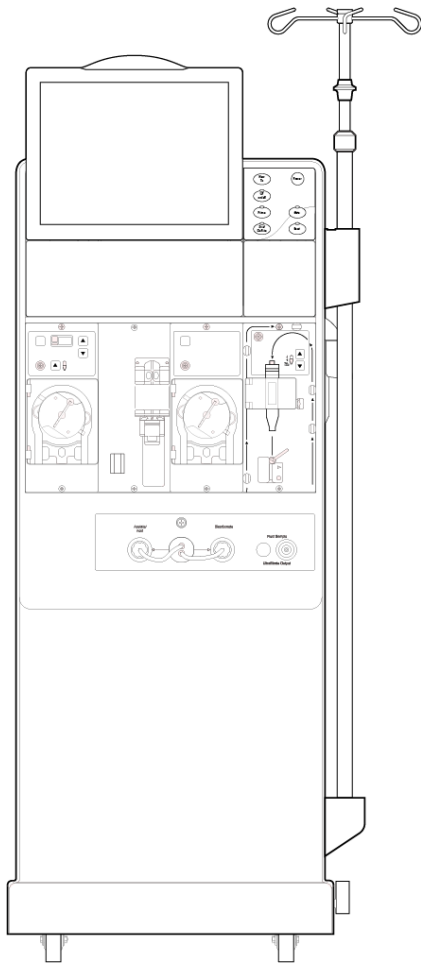

The 2008T hemodialysis machine can be set up for either double needle dialysis (see “Preparing the Extracorporeal Blood Circuit” on page 56) or single needle dialysis. Single needle dialysis is a system that uses two blood pumps to allow blood access to the patient with a single needle. The pumps alternately cycle on and off to pull blood from the patient and return the dialyzed blood with minimal recirculation.

After setting up the concentrates (see “Preparing the Dialysis Delivery System” on page 53), use the instructions on the next page to set up the single needle bloodlines on the machine.



Note: Before using these instructions, the Single Needle Blood Pump module must be installed in the 2008T hemodialysis machine. The Service Mode “Options: Module Options” screen Digital SN Blood Pump option must be set to ‘Yes’. See the *Single Needle 2008K Series Blood Pump Installation Instructions* (P/N 507639) for more information.

Note: The Single Needle Blood Pump module is paired with a specific arterial blood pump module. It will only work with this blood pump.

Preparing the Single Needle Extracorporeal Blood Circuit

Use Figure 102 below as a guide for connecting the bloodlines using the Single Needle Blood Pump module. The red lines on the machine are guides for the arterial bloodline (from patient to dialyzer). The blue lines on the machine are guides for the venous bloodline (from the dialyzer to the patient). Be sure to use aseptic technique for all bloodline connections.

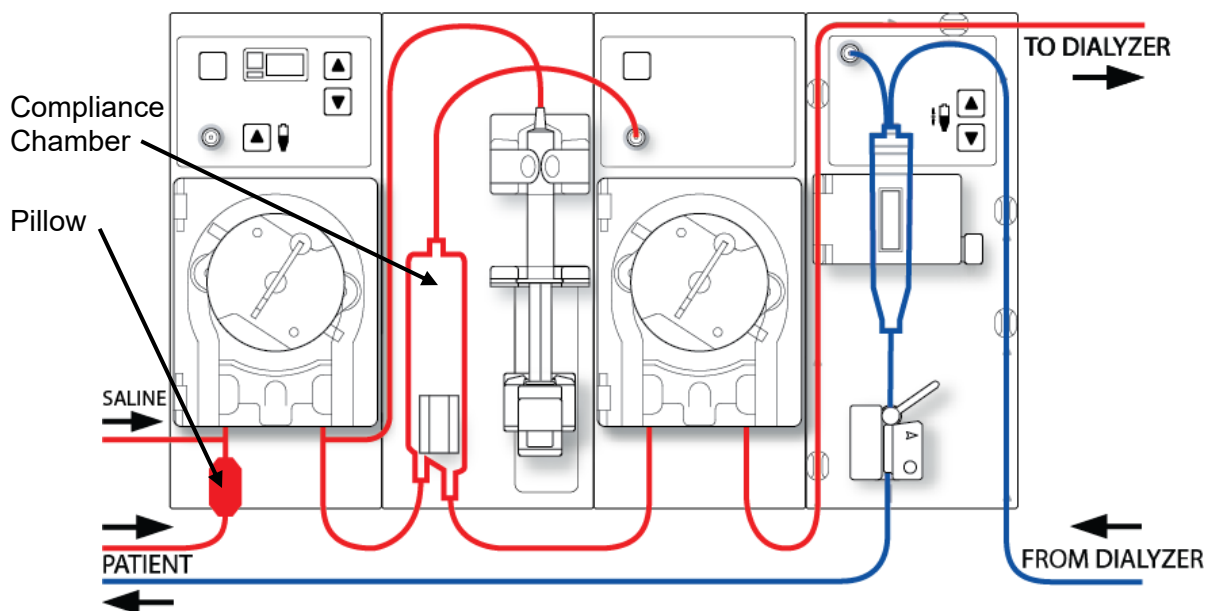

Figure 102 – Module Configuration with Digital Single Needle Pump (third module from left)

Connecting the Single Needle Extracorporeal Blood Circuit

For the following set of instructions, refer to Figure 13 – The Blood Pump Module on page 41 regarding the names of the various blood pump parts. Refer to Figure 15 – The Level Detector Module on page 43 regarding the names of the various Level Detector module parts.

To connect the bloodlines:



Warning! Use aseptic technique.



Note: These instructions are for Fresenius Medical Care CombiSet Single Needle Bloodlines (P/N 03-2696-7) using a new, dry-pack dialyzer. If you use a different bloodline set, your medical director is responsible for providing alternate instructions.

Fresenius Medical Care manufactures bloodlines for use with the 2008T hemodialysis machine. The performance of bloodline sets not manufactured by Fresenius Medical Care cannot be guaranteed by Fresenius Medical Care and are therefore the responsibility of the prescribing physician.

Arterial Bloodline Setup

1. Close the medication port clamp located on the short line at the top of the compliance chamber.
2. Snap the compliance chamber into its holder.
3. Connect the arterial monitor line to the pressure port (P_{SN}) on the Single Needle Blood Pump module using a transducer protector. Verify that the monitor line is unclamped.



Warning! Transducer protectors should be used between transducers and each pressure monitor line of the extracorporeal system to prevent the transducers from getting wet. Wet transducer protectors must be replaced, as they will cause inaccurate pressure readings. If the external transducer protector and the internal transducer should become contaminated with blood, the transducer protectors **must** be replaced, and the transducer must be disinfected or replaced.

4. Locate the “pillow” on the patient end of the arterial bloodline; the pump segment directly above the pillow is the first blood pump segment, this pump segment should be loaded into the arterial blood pump (the first blood pump from the left).
5. Open the arterial blood pump door.



Warning! Inspect the blood pump rotor for proper operation (tubing guide posts not bent, rollers move freely, crank lever moves freely). Bent or loose tubing guide posts can damage bloodlines. Replace rotor if necessary. See page 185 for rotor diagram.

6. If necessary, set the Arterial Blood Pump module for the diameter of the blood pump segment:
 - Press the Up (▲) and Down (▼) keys on the Arterial Blood Pump module simultaneously. The display will flash.
 - Press the Up (▲) or Down (▼) key on the Arterial Blood Pump module until the diameter of the pump segment (8.0) being used is displayed.
7. Load the arterial blood pump segment into the arterial blood pump:
 - a. Press and hold the **Start/Stop** key on the Arterial Blood Pump module to align the pump rotor for line insertion.
 - b. Grasp the pump segment and, using thumb pressure, position it behind the left yoke by pressing the tubing retainer inward. Be sure the end of the segment clears the bottom of the yoke.



Warning! Make sure the collar of the pump segment is positioned below the bottom of the yoke. This will minimize the possibility of the segment kinking during pump operation.

- c. Press and hold the **Start/Stop** key. The rotor will rotate to the 5 o'clock position and stop. Relieve pressure on the retainer and release the segment. The beginning of the pump segment should be secured between the left yoke and the tubing retainer.
-



Warning! Keep fingers free of rotor while it is turning to avoid possible injury.

- d. Press and hold the **Start/Stop** key again and the rotor will rotate one full turn to automatically position the remainder of the segment within the pump housing. After loading, any extra pump segment tubing length should be on the right side of the pump.

- e. Release the **Start/Stop** key when the pump segment has been inserted along the track inside the pump housing all the way to the right yoke.
 - f. Grasp the remaining portion of the segment and, using thumb pressure in a manner similar to step b, position it behind the right yoke.
 - g. Release the tubing retainer and close the pump door. Be sure the pump segment is free of kinks and both ends of the segment extend below the yoke.
8. Drape the second blood pump segment over the top of the single needle blood pump—do not insert the single needle blood pump segment into the single needle blood pump at this time.
 9. Snap remaining arterial tubing in the clips along the red guidelines shown on modules.
 10. Aseptically connect the patient end of the arterial line to the priming receptacle. Snap the dialyzer end of the arterial bloodline into the dialyzer holder clip.



Warning! Do not allow the ends to touch the fluid in the bucket to prevent contamination.

Venous Bloodline Setup

1. Close medication port clamp
2. Open the level detector door and roll the venous drip chamber into its holder with the filter below the sensor heads. Close and latch the door.



Warning! The level detector must be calibrated to the venous line model being used.

Warning! If the venous chamber contains a filter, be sure the filter portion of the chamber is positioned below the ultrasonic sensor heads of the drip chamber holder.

3. Connect the venous pressure monitor line to the pressure port. Be sure to insert a transducer protector between the line and the port. Verify that the monitor line is unclamped.



Warning! Transducer protectors should be used between transducers and each pressure monitor line of the extracorporeal system to prevent the transducers from getting wet. Wet transducer protectors must be replaced, as they will cause inaccurate pressure readings. If the external transducer protector and the internal transducer should become contaminated with blood, the transducer protectors **must** be replaced, and the transducer must be disinfected or replaced.

4. Snap remaining venous tubing in the clips along the blue guidelines shown on modules (do not insert the venous bloodline into the venous clamp yet).
5. Snap the dialyzer end of the venous bloodline into the dialyzer holder clip.
6. Aseptically connect the patient end of the venous line to the priming receptacle.



Warning! Do not allow the ends to touch the fluid in the bucket to prevent contamination.

Dialyzer Setup

1. Mount the dialyzer in its holder, arterial-end up. Screw dialyzer caps onto the dialyzer ports.

Priming the Single Needle Blood Circuit

There are two different ways to prime the blood circuit on the 2008T hemodialysis machine:

- Standard Prime method: This method allows the operator to prime the blood circuit by controlling the flow of the saline manually.
- Prime Amount method: This method limits the amount of saline used in the priming procedure to a preset volume. The preset volume (Prime Amount) is set in Service Mode.

Prime the blood circuit according to how your machine was set up. Follow your unit protocol or dialyzer manufacturer's instructions for priming and rinsing dialyzers.

Standard Prime Method

1. Connect the dialyzer end of the arterial bloodline to the arterial port of the dialyzer. Rotate the dialyzer to the arterial end down position.
2. Connect the dialyzer end of the venous bloodline to the venous port of the dialyzer.
3. Insert the venous bloodline into the venous line clamp and optical detector on the Level Detector module. Close the optical detector door.



Warning! The tubing beneath the venous drip chamber must be inserted into the venous line clamp and the optical detector.

4. Hang a saline bag and attach an administration line to the saline port on the arterial bloodline below the arterial blood pump. Aseptically spike the saline bag.
5. Gravity prime the patient end of the arterial bloodline below the saline "T" with saline. When primed, clamp the patient end of the arterial bloodline.
6. If the heparin pump is to be used: connect the heparin syringe, prime the heparin line with heparin, and load the heparin syringe into the Heparin Pump module. If the heparin pump is not used, clamp the heparin line.
7. Press the **Prime** key on the control panel.
8. Press the **Start/Stop** key on the Arterial Blood Pump module and run the pump at a rate of 150 ml/min. Adjust the flow rate by pressing the ▲ (up) or ▼ (down) keys. The compliance chamber will automatically fill to an acceptable level.



Warning! The ▲ **Level Adjust** key on the Arterial Blood Pump module can only be used to raise the level in the compliance chamber. Do not press the ▲ **Level Adjust** key so long that the pressure transducer protector becomes wet. Wet transducer protectors must be replaced to avoid erroneous pressure readings.

9. Run the arterial blood pump to flush additional saline through the dialyzer until a fluid level is detected in the venous drip chamber. The blood pump will stop when the level

- detector detects an acceptable level of fluid or two minutes have elapsed, whichever comes first.
10. Press the **Reset** key on the control panel to restart the arterial blood pump and continue flushing saline through the blood circuit in accordance with established facility protocol regarding dialyzer rinsing.
 11. After the required saline amount has passed through the dialyzer, press the **Start/Stop** key on the Arterial Blood Pump module to stop the pump.
 12. Clamp the patient end of the venous bloodline.
 13. Adjust the fluid level in the venous drip chamber by pressing the appropriate ▲ or ▼ level adjust keys on the Level Detector module. Close the venous pressure monitor line clamp and disconnect the monitor line from the venous pressure port so the port is open to atmosphere.
 14. Aseptically connect the patient end of the arterial bloodline to the patient end of the venous bloodline using a sterile recirculation piece. Unclamp both lines.
 15. Set the arterial blood pump rate to 350-400 ml/min. Press the **Start/Stop** key on the Arterial Blood Pump module to start the pump and begin recirculation. Do not insert the single needle blood pump segment into single needle blood pump. If necessary, press the **Reset** key to clear any alarms.
 16. Ensure that the extracorporeal blood circuit is free of air bubbles.



Note: The dialysate lines will have to be attached at the appropriate point during the priming process, depending on facility procedure and manufacturer's instructions. If 1.5x or 2x dialysate flow (Auto Flow) is selected, be sure that the dialysate flow rate is at least the minimum required rate.

Prime Amount Method

1. Connect the dialyzer end of the arterial bloodline to the arterial port of the dialyzer. Rotate the dialyzer to the arterial end down position.
2. Connect the dialyzer end of the venous bloodline to the venous port of the dialyzer.
3. Hang a saline bag and attach an administration line to the saline port on the arterial bloodline below the arterial blood pump. Aseptically spike the saline bag.
4. Gravity prime the patient end of the arterial bloodline below the saline "T" with saline. When primed, clamp off the patient end of the arterial bloodline.
5. If the heparin pump is to be used: connect the heparin syringe, prime the heparin line with heparin, and load the heparin syringe into the Heparin Pump module. If the heparin pump is not used, clamp the heparin line.
6. Press the **Prime** key on the control panel.

7. Press the **Start/Stop** key on the Arterial Blood Pump module and run the pump at a rate of 150 ml/min. Adjust the flow rate by pressing the ▲ (up) or ▼ (down) keys. The compliance chamber will automatically fill to an acceptable level.



Warning! The ▲ **Level Adjust** key on the Arterial Blood Pump module can only be used to raise the level in the compliance chamber. Do not press the ▲ **Level Adjust** key so long that the pressure transducer protector becomes wet. Wet transducer protectors must be replaced to avoid erroneous pressure readings.

8. The arterial blood pump will start and continue to run until the pre-set amount of saline has been flushed through the circuit. When the blood pump stops, clamp the patient end of the venous bloodline.
9. Insert the venous bloodline into the venous line clamp and optical detector on the Level Detector module. Close the optical detector door.



Warning! The tubing beneath the venous drip chamber must be inserted into the venous line clamp and the optical detector.

10. Adjust the fluid level in the venous drip chamber by pressing the appropriate ▲ or ▼ level adjust keys on the Level Detector module. Close the venous pressure monitor line clamp and disconnect the monitor line from the venous pressure port so the port is open to atmosphere.
11. Aseptically connect the patient end of the arterial bloodline to the patient end of the venous bloodline using a sterile recirculation piece. Unclamp both lines.
12. Set the arterial blood pump rate to 350-400 ml/min. Press the **Start/Stop** key on the Arterial Blood Pump module to start the pump and begin recirculation. Do not insert the single needle blood pump segment into single needle blood pump. If necessary, press the **Reset** key to clear any alarms.
13. Ensure that the extracorporeal blood circuit is free of air bubbles.



Note: The dialysate lines will have to be attached at the appropriate point during the priming process, depending on facility procedure and manufacturer's instructions. If 1.5x or 2x dialysate flow (Auto Flow) is selected, be sure that the dialysate flow rate is at least the minimum required rate.

Testing the 208T hemodialysis machine with Single Needle blood pump

Follow the instructions in the “Testing the 208T Hemodialysis Machine” section on page 72.

Recirculation and Final Set-Up Procedure with Single Needle Blood Pump



Note: If you are using a reused dialyzer, you cannot run recirculation with the single needle blood pump segment inserted. Recirculation is achieved with the arterial blood pump.

1. Rotate the dialyzer to arterial inlet up.
2. Check the conductivity and pH of the dialysate and test for residual disinfectant before connecting the dialysate lines to the dialyzer. For more information on collecting a dialysate sample for testing, see “Testing the Dialysate” on page 359.



Warning! Always verify the conductivity and approximate pH of the dialysate solution through independent means before initiating each dialysis treatment. Independent means could be by using an external conductivity meter, pH meter, pH paper or by using the machine’s independent conductivity test. An approximate pH check is also part of the machine’s independent conductivity test when a bibag disposable is connected. Verify that the conductivity is within 0.4 mS/cm of the theoretical conductivity value (TCD) and the pH is between 6.9 and 7.6 if using a pH meter or pH paper. If conductivity and pH are not within these limits, do not initiate dialysis. The machine’s independent conductivity test relies on the use of prequalified manufactured acid concentrates or verified batch concentrates; the pH check relies on the use of these concentrates and the *bi*bag. For more information on collecting a dialysate sample for external testing, see “Testing the Dialysate” on page 359.

3. Connect the dialysate lines to the dialyzer by matching the color of the dialyzer connector to the color of the blood tube fitting and then close the shunt door. When done correctly, the red arterial blood tubing connector and the red dialyzer connector of the dialysate line should be connected to the corresponding ports at the top of the dialyzer. This is to create a counter-current flow (blood flowing from top to bottom, dialysate flowing from bottom to top) inside the dialyzer to maximize clearance.
4. Pull on the dialyzer connectors to make sure they are firmly connected to the dialyzer.



Note: All dialyzer connectors must be fastened tightly to prevent air from entering the dialysate circuit or to prevent dialysate from leaking from the dialyzer.

5. Reconnect the venous monitor line to the venous pressure port. Unclamp the venous pressure monitor line.
6. When the dialysate compartment is filled, rotate the dialyzer so the arterial inlet is down.
7. After priming the extracorporeal blood circuit, press **Reset** to clear all alarms. Set the blood pump rate to 350-400 ml/min and start the blood pump to begin recirculating the saline through the circuit.
8. Press the ▼ (down) key on the Level Detector module to lower the fluid level in the drip chamber. Verify that the blood pump stops and the venous clamp occludes.



Warning! The test of the level detector system must be run as a precaution and aid to identifying potential failures. Remove the machine from service if it fails this test.

9. Press the ▲ (up) key on the Level Detector module to raise the fluid level in the drip chamber to an acceptable level.
 10. Check blood tubing to ensure that there are no kinks, especially between the blood pump and the dialyzer.
-



Warning! Check all bloodlines for kinking. Improper blood flow may cause hemolysis of the blood.

Warning! If using a dialyzer that has been stored in a liquid disinfectant such as formaldehyde, test the recirculating saline solution for residual disinfectant according to established facility protocol or the manufacturer's instructions. Special rinsing techniques must also be employed to assure the concentration of disinfectant is reduced and maintained at an appropriate level. These rinsing procedures are the responsibility of the medical director. The procedure must include a test for residual disinfectant and techniques to avoid rebound of the disinfectant. Turning the dialysate flow off when using a reused dialyzer may allow the chemical disinfectant to rebound (increase) to an unacceptable level.

11. Replace the saline bag with a fresh bag if necessary.
 12. Check for a normal dialysate flow by observing the rise and fall of the external flow indicator located on the dialyzer supply line. The float should drop four times in about 15 seconds for a 500 ml/min flow, or four times in 10 seconds for an 800 ml/min flow.
 13. Open the shunt door and verify that the machine goes into bypass mode. In bypass mode, the float in the flow indicator of the dialyzer supply line should drop and remain at the bottom of the indicator and an audible alarm may sound.
-



Note: The 2008T hemodialysis machine can be configured (in Service mode) so that audible alarms occur only when the optical detector senses blood. If this option is not selected, an audible alarm will sound when the shunt interlock door is open.

Setting Single Needle Dialysis Treatment Parameters

Follow the instructions in the “Setting Treatment Parameters” section on page 77. The Single Needle option on the “Test & Options” screen will be set after inserting the single needle blood pump segment in the next section.

Starting Single Needle Dialysis

At this point, all treatment parameters and options should have been entered. Dialysate should already be verified for absence of disinfectant, verification of prescription, conductivity, and pH should also be confirmed. It is now time to insert the single needle blood pump segment and connect the patient to the 2008T hemodialysis machine via the blood tubing and begin the dialysis treatment.

1. Press the **Start/Stop** key on the Arterial Blood Pump module to stop the blood pump.
2. Open the single needle blood pump door to insert the single needle blood pump segment.



Warning! Inspect the blood pump rotor for proper operation (tubing guide posts not bent, rollers move freely, crank lever moves freely). Bent or loose tubing guide posts can damage bloodlines. Replace rotor if necessary. See page 185 for rotor diagram.



Caution: If you are using a Single Knob Single Needle Blood Pump module, you must make sure that the pump is set for the diameter of the blood pump segment.



Note: If you are using a Single Knob Single Needle Blood Pump module, you must manually load the single needle blood pump segment: Thread the single needle blood pump segment into the single needle pump using the rotor latch (see Figure 81 #1 on page 169) to rotate the single needle pump rotor clockwise. Make sure the left and right pump segment connectors are positioned below the left and right yokes and the line is free from kinks.

3. Load the single needle blood pump segment:
 - a. Press and hold the **Start/Stop** key on the Single Needle Blood Pump module to align rotor for line insertion.
 - b. Grasp the pump segment and, using thumb pressure, position it behind the left yoke by pressing the tubing retainer inward. Be sure the end of the segment clears the bottom of the yoke.



Warning! Make sure the collar of the pump segment is positioned below the bottom of the yoke. This will minimize the possibility of the segment kinking during pump operation.

- c. Press and hold the **Start/Stop** key. The rotor will rotate to the 5 o'clock position and stop. Relieve pressure on the retainer and release the segment. The beginning of the pump segment should be secured between the left yoke and the tubing retainer.



Warning! Keep fingers free of rotor while it is turning to avoid possible injury.

- d. Press and hold the **Start/Stop** key again and the rotor will rotate one full turn to automatically position the remainder of the segment within the pump housing. After loading, any extra pump segment tubing length should be on the right side of the pump.
 - e. Release the **Start/Stop** key when the pump segment has been inserted along the track inside the pump housing all the way to the right yoke.
 - f. Grasp the remaining portion of the segment and, using thumb pressure in a manner similar to step b, position it behind the right yoke.
 - g. Release the tubing retainer and close the pump door. Be sure the pump segment is free of kinks and both ends of the segment extend below the yoke.
4. On the “Test & Options” screen, select the **Single Needle** toggle-button to set it to ‘On’ and press the **CONFIRM** key to confirm the change.
5. Press the **Start/Stop** key on the Arterial Blood Pump module to start the blood pump.



Note: If using a Single Knob Single Needle Blood Pump module, set the single needle blood flow rate to approximately 20% higher than the arterial blood pump rate. The blood flow rate displayed on the Arterial Blood Pump module with the Single Needle option set to ‘On’ equals the average blood flow rate for both pumps.



Note: Allow the system to recirculate several times before connecting the patient to assure that the extracorporeal circuit is ready.

6. Before starting dialysis, complete the patient assessment per unit policy.
 7. Wrap the blood pressure cuff around the patient's non-access arm.
-



Warning! Be sure the cuff is the correct size and placed at heart level. An improperly fitted cuff may cause inaccurate blood pressure readings due to under or over compression of the brachial artery. Each centimeter above or below heart level will cause an error of ± 0.8 mmHg.

8. Verify that ultrafiltration is off (UF light is off), and that the **UF Removed** button is reset to zero. The UF removed may be reset by selecting the **UF Removed** button and then pressing the **0** key and confirming the change.
 9. Verify that the venous line is in the venous clamp and the optical detector. Verify that the optical detector door is closed.
-



Warning! Do not infuse the recirculated saline prime into the patient. Discard the recirculated saline and fill the extracorporeal circuit with fresh saline prior to connecting to the patient. The volume of fresh saline used to fill the extracorporeal circuit should be equal to the volume of the dialyzer and blood tubing set in use.



Note: Follow established unit protocol regarding procedures for establishing aseptic blood connections.

10. Lower the arterial blood pump rate to 150 ml/min and then press the **Start/Stop** key on the Arterial Blood Pump module to stop the pump.
 11. Connect the patient and initiate treatment according to unit protocol.
-



Warning! Check all bloodline and dialysate line connections for fluid leaks. Keep access sites uncovered and monitored. Improper bloodline connections or needle dislodgements can result in excessive blood loss, serious injury, and death. Machine alarms may not occur in every blood loss situation.

12. Start the arterial blood pump and adjust the blood flow rate to establish dialysis and the alarm limits. Establish the prescribed blood flow rate. When the pressure in the compliance chamber reaches 180 mmHg, the arterial pump will stop and the single needle pump will start. When the pressure in the compliance chamber drops to 80 mmHg, the single needle blood pump stops and the arterial blood pump starts again. The pumps continue to cycle in this manner for the duration of the treatment.
 13. Rotate the dialyzer to arterial inlet up.
 14. Select the **Tx Clock** button and press **CONFIRM** to start the treatment.
 15. Check that the UF/SVS/Heparin are on, if prescribed. If applicable, a blood pressure measurement is initiated.
-



Warning! When establishing blood flow, ensure that air will not be infused into the patient.

Warning! Check all bloodlines for kinking. Improper blood flow may cause hemolysis of the blood.

Monitoring the Single Needle Dialysis Treatment

Follow the instructions in the “Monitoring the Treatment” section on page 137.



Warning! Administration of intravenous solution during single needle operation requires the use of a sterile one-way valve between the administration set and the infusion site to prevent back up of solution.

Single Needle Alarms and Troubleshooting

Follow the instructions in the “Alarms and Troubleshooting” section on page 198.

Blood Recirculation Procedure during Single Needle Dialysis

Follow the instructions in the “Blood Recirculation Procedure” section on page 167.

Power Failure during Single Needle Dialysis

Follow the instructions in the “Power Failure during Dialysis” section on page 168.

Completion of the Single Needle Dialysis Treatment

At the end of treatment, when the RTD timer has counted down to 0:00, a Low Alarm sounds and the message, “RTD = Zero”, appears in the Status Box. A Low Alarm also sounds when the set amount of ultrafiltrate has been removed. When that happens, the Status Box displays the message, “UF Goal Reached”. To reset either alarm, press the **Reset** key. If the “UF Goal Reached” and “RTD = Zero” alarms occur simultaneously, pressing the **Reset** key will reset both alarms.

When the UF Goal is reached, the UF Rate automatically drops to 70 ml/hr (or 300 ml/hr if the ‘High Flux’ option in the “Test & Options” screen is selected).

Returning Blood to the Patient

1. Select the **Tx Clock** button and then press the **CONFIRM** key to stop the treatment
2. Press the **Start/Stop** key on the Arterial Blood Pump module to stop the pump
3. On the “Test & Options” screen, select the **Single Needle** toggle-button to set it to ‘Off’ and press the **CONFIRM** key to confirm the change.
4. Remove the single needle blood pump segment from the single needle blood pump:
 - a. Open the door and align the rotor by pressing and holding the **Start/Stop** key until the pump stops.

- b. Press the latch below the rotor to release the left (incoming) side of the pump segment. Pull the first couple of inches of the pump segment out of the pump.
 - c. While keeping firm tension outward on the left (incoming) side of the bloodline, press and hold the **Start/Stop** key a second time and the pump segment will be released from the pump head.
5. Replace saline bag with a fresh bag if necessary
 6. Rinse the blood in the bloodline back to the patient:
 - a. Clamp the arterial bloodline directly below the saline “T”
 - b. Open the saline line clamps
 - c. Start the blood pump and set a rate of 150-200 ml/min
 - d. When the blood has been returned to the patient, turn the blood pump off and close the saline line clamps
 7. Rinse the remaining blood in the arterial bloodline back to the patient:
 - a. Remove the clamp from below the saline “T” and then clamp the arterial bloodline directly above the saline “T”
 - b. Open the saline line clamps
 - c. When the blood has been returned to the patient, close the saline line clamps



Warning! Check all bloodlines and dialysate lines for leaks. Keep access sites uncovered and monitored. Improper bloodline connections or needle dislodgements can result in excessive blood loss, serious injury, and death. Machine alarms may not occur in every blood loss situation.

8. Clamp the arterial and venous bloodlines and the patient’s arterial and venous access lines, and aseptically disconnect them.



Note: Depending on how your machine was configured, an audible alarm may sound when the saline solution reaches the optical sensor. Press **Reset** to silence the alarm.

Continue with the instructions listed in the “Removing the Dialyzer” section on page 178.

Sustained Low Efficiency Dialysis (SLED) (Optional)

Sustained Low Efficiency Dialysis (SLED) is an option used in a critical-care facility for patients requiring temporary, short-term dialysis treatment due to trauma or hemodynamic instability. Unlike dialysis treatment for patients with chronic kidney disease, patients are dialyzed continuously over a longer period of time, up to twelve hours. With SLED treatments, the dialysate flow rate is set between 100–300 ml/minute and the blood flow rate is 300 ml/min or less.

For the most part, preparing the 2008T hemodialysis machine and setting treatment parameters in the SLED program are the same as in the Dialysis program. This appendix identifies and addresses SLED issues that are not covered in the earlier chapters of this manual. As with normal dialysis, all treatment parameters must be prescribed by a physician.



Note: The Diasafe Filter Service Mode option must be set to ‘Yes’ in order to use SLED program.

Preparation

The water and dialysate supplied for treatment must meet ANSI/AAMI standards for dialysis. If a reverse osmosis (RO) water treatment unit is used, follow the manufacturer’s instructions regarding set up and testing procedures. Check RO-processed water for residual disinfectant and make sure the water is within acceptable limits before connecting the water supply to the 2008T hemodialysis machine.

To prepare the 2008T hemodialysis machine for SLED, follow the instructions in Chapter 2, “Daily Preparation for Treatment.”



Note: Indicate on the concentrate jugs the date and time the bicarbonate was mixed or opened to ensure solution stability.

When setting patient-specific, treatment parameters, follow the instructions in Chapter 3, “Setting Treatment Parameters.” Some notable exceptions to chapter 3 are:

- UF or SVS profiles are not available in SLED
- No UF Time, UF Goal, or RTD to set in SLED
- No Low Volume option on the “Test & Options” screen
- No “Trends,” “Kt/V AF,” and “BTM BVM” screens
- Crit-Line screen is not available in SLED

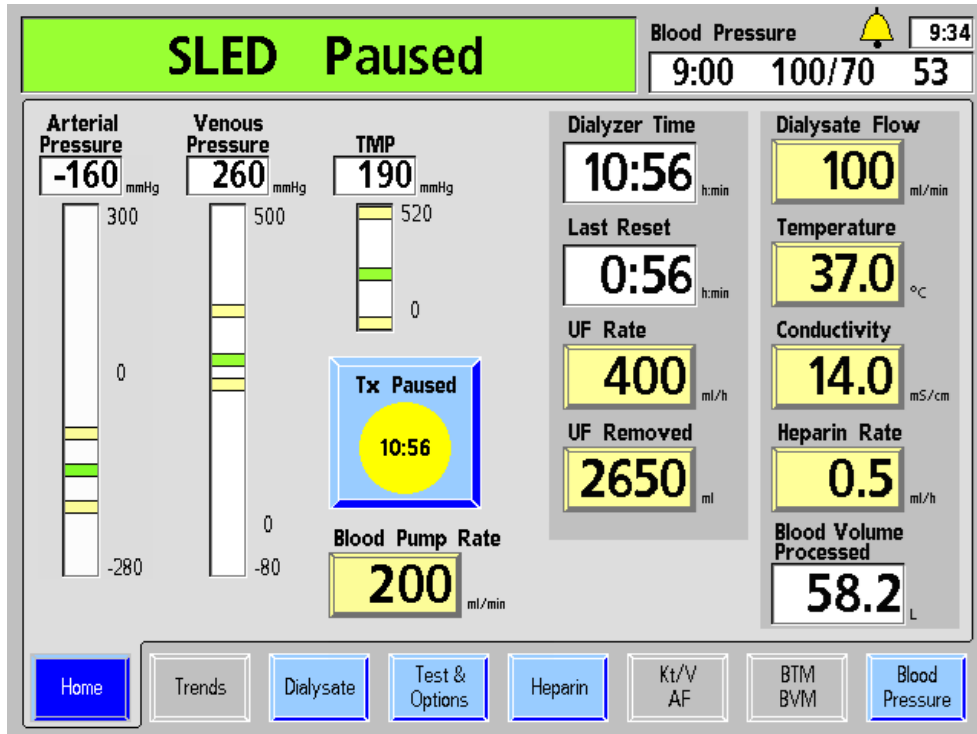

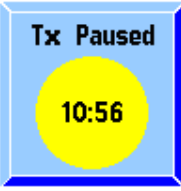



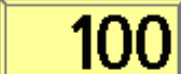
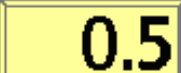
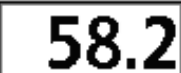

Figure 103 – The SLED “Home” screen

The following table describes the features that are unique to the SLED “Home” screen. For descriptions of features not shown in the table, see the table of descriptions for the Dialysis “Home” screen buttons on page 94.

Table 37 – SLED “Home” Screen Features

Feature	Function
	<p>The Treatment (Tx) Clock button displays the time the SLED treatment has been running (in hours:minutes); this time is limited to 12 hours and does not increment if the blood pump is stopped or if there is a water alarm. Selecting and confirming the Tx Clock button will start or pause the treatment.</p>
	<p>When the treatment is paused, the treatment time stops incrementing, the heparin infusion time stops counting down, and the UF and heparin pumps stop. The appropriate LED indicators will flash. Turning the Treatment Clock back on will restore operation of these parameters unless turned off with the respective front panel on/off key.</p> <p>The first time the Treatment Clock is turned on, the UF Removed is reset to 0, the UF and the heparin pumps are turned on, and a blood pressure reading is taken, if applicable.</p> <p>When the Treatment Time displayed in the button reaches 12:00 (hours), the non-resettable alarm, “SLED Complete,” is displayed in the Status Box, an alarm sounds, the dialysate flow stops, and the UF pump stops.</p>

Feature	Function
Blood Pump Rate 	The Blood Pump Rate button displays the speed of the blood pump and allows the operator to set it from the display screen in addition to the module. The rate, displayed in ml/min, can be entered from 0 to 300 in increments of 5. Setting the blood flow rate to zero will stop the blood pump. The blood flow rate flashes when the blood pump is stopped.
Dialyzer Time 	The Dialyzer Time meter box acts as a timer that displays elapsed time (in hours:minutes) that the dialysate lines have been connected to the dialyzer with blood sensed. The timer begins when the Tx Clock button is selected and confirmed to start treatment, changing from 'Tx Paused' to 'Tx Running'. The Dialyzer Time value resets to zero when the dialysate lines are placed on the shunt.
Last Reset 	The Last Reset data box displays the amount of time (in hours:minutes) since the UF Removed button was reset to zero. This value automatically resets when UF Removed is set to 0.
UF Rate 	Enter here, in 10 ml/hr increments, the rate fluid will be drawn from the patient (ultrafiltration). For SLED, the UF rate is limited to a maximum of 1000 ml/hr.
Dialysate Flow 	The prescribed dialysate flow rate, in ml/min, is entered here. For SLED, the dialysate flow rate can be set to 100, 150, 200, or 300 (default) ml/min.
Heparin Rate 	The Heparin Rate button displays the rate at which heparin is dispensed during treatment. It can be set from 0.0 to 9.9 ml/hour. Setting the rate to 0 turns off the heparin pump. The rate can be adjusted from the "Home" screen or the "Heparin" screen.
Blood Volume Processed 	The Blood Volume Processed meter box displays, in liters, the amount of blood that has passed through the dialyzer since the last dialyzer time reset.

Treatment Monitoring

Refer to Chapter 4, "Monitoring the Treatment," for descriptions of the screen features used to monitor the progress of the treatment. Per hospital policy, the dialysis nurse or ICU staff should record the initial parameters of the treatment as well as at fixed intervals. Because the UF Rate reflects only the rate at which fluid is removed from the patient, all fluid intakes (IV solution, nutrition, medication, etc.) and outputs (UF Rate, residual kidney function, drainage, etc.) have to be considered for determining fluid balance of the patient. It may be necessary to readjust the UF rate hourly.

With each check, the dialysis nurse or ICU staff should ensure that enough heparin and acid and bicarbonate concentrates is available for the next hour to prevent unnecessary alarms.

Dialyzer Replacement

The 2008T hemodialysis machine should be heat or chemical disinfected and the complete extracorporeal circuit, including the dialyzer, should be replaced according to hospital policy. After a maximum of 12 hours treatment, the machine will display the non-resettable message “SLED Complete” and ultrafiltration and dialysate flow will stop.

After 12 hours of treatment:

1. Record the treatment parameters
2. Select the **Tx Clock** button and press **CONFIRM** to pause the treatment.
3. Follow the procedures in Chapter 4, “Completion of Dialysis” on page 171.



Warning! If UF Removed value is not cleared, the fluid balance may be miscalculated.

Warning! Check all bloodlines and dialysate lines for leaks. Keep access sites uncovered and monitored. Improper bloodline connections or needle dislodgements can result in excessive blood loss, serious injury, and death. Machine alarms may not occur in every blood loss situation.

4. From the “Select Program” screen, select Heat Disinfect and press CONFIRM. During heat disinfection, the RO unit, if used, can be disconnected from the 2008T hemodialysis machine once the water temperature reaches 80 °C (176 °F) and the recirculation cycle starts. If an RO unit equipped with a softener is used, check the hardness level and, following the manufacturer’s instructions, regenerate the softener per facility policy.
5. When Heat Disinfection is completed, reconnect the water supply (if necessary) and run a Rinse program from the “Select Program” screen to cool down the machine.
6. After the Rinse cycle, repeat the set-up procedure (including the Alarm and Pressure tests) and resume SLED as prescribed.

Appendix C

The CDX™ System (Optional)

The Clinical Data eXchange (CDX) system is an independent PC that is built into the 2008T hemodialysis machine. The CDX PC can run software programs that are displayed on the 2008T display screen and accessed with the keyboard, touchscreen, and touchpad like any other personal computer (PC). Pressing the blue **CDX** key on the keyboard (see Figure 104) will switch between displaying Dialysis/SLED and CDX.



Figure 104 – The Keyboard

The **CDX** key

The 2008T hemodialysis machine will automatically switch from CDX to Dialysis/SLED:

- During hemodialysis alarms
- By pressing any control panel key except for the **Power** key (see Figure 105 on the next page)
- If no input (keyboard, touchpad, etc.) is received for two minutes when blood is sensed and the Tx Clock is running



Warning! An overview of the cybersecurity controls implemented within the 2008T machine is available upon request in the “Manufacturer Disclosure Statement for Medical Device Security (MDS2)” with or without CDX. Fresenius Medical Care continuously monitors security threats, vulnerabilities, and security incidents, including vulnerabilities identified by the operating system and third-party software vendors, customers, and security researchers. The Fresenius Medical Care PSIRT (Product Security Incident Response Team) then will evaluate potential security incidents and vulnerabilities and develop

remediations as necessary.

Additionally, Fresenius Medical Care advises the following industry best practices to promote a defense-in-depth strategy for secure operation of the 2008T machine:

- Conduct a comprehensive security risk assessment on the medical network in accordance with operational security best practices such as ISO 27002
- Ensure local procedures include inspection of the 2008T machine for physical tampering prior to each use
- Ensure that all portable media used for data exchange with the medical network (such as CDs, USB drives, etc.) are scanned before use
- Implement physical controls that ensure no unauthorized persons would have physical access to the 2008T machine

For systems with network connectivity:

- Ensure all network connected systems are kept up to date with relevant security patches
- Minimize remote access to the network and implement multi-factor authentication
- Minimize network exposure for the 2008T machine, and ensure that it is not accessible from the Internet
- Locate the 2008T machine behind firewalls, in dedicated medical networks isolated from all other IT networks
- Ensure state-of-the-art data encryption is implemented for all Wi-Fi communications
- Implement application firewalls capable of deep packet inspection to help protect against zero-day vulnerabilities and the latest exploits
- Ensure that all programming software and equipment (service laptops, etc.) are kept up to date with the latest software updates and patches, only connected to a network for their intended purpose, and kept physically protected (locked) locations when not in use.

Failure to ensure a secure operating environment for the 2008T machine may put prescription data sent to the machine at risk.



Note: CDX is unavailable during an alarm when blood is sensed and the Tx Clock is running.

Note: CDX should be enabled before midnight on the day before it is to be used. It is designed to work on the following calendar day after it is first enabled in Service Mode.

Note: The CDX PC operating system is provided as a convenience. Due to the normal course of operating system updates, it may not reflect the most recent version available. It is the responsibility of the customer to take the necessary actions to update, customize and maintain the security within the CDX PC operating system to avoid potential security breaches.

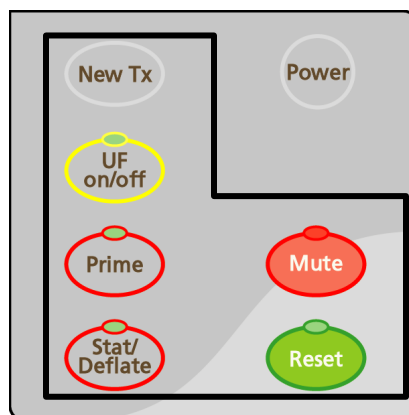

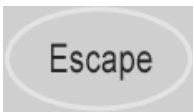

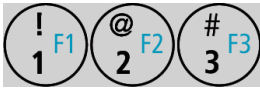
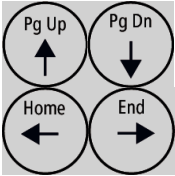
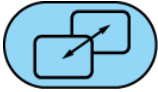





Figure 105 – The Control Panel keys that switch CDX to Dialysis Mode

When the machine is displaying CDX, the keyboard, touchscreen and touchpad control only the CDX system. The table below lists machine controls that change when displaying CDX.

Table 38 – CDX Controls on the keyboard and touchpad

Feature	Function
	The CONFIRM key on the touchpad functions like the left button on a computer mouse, press to select an item.
	The Escape key on the touchpad functions like the right button on a computer mouse, press to bring up an item specific menu.
	The touchpad controls an on-screen cursor for the CDX application.
	Enter numerical values; hold the Shift key to input the symbols above the numbers; press the Fn Lock key to select the key's secondary function (F1-F12).
	Move the cursor in the direction specified by the arrow. Note: Holding down the Shift key while pressing an arrow key will shift to the secondary function printed on the key.
	Pressing the blue CDX key will switch back and forth between displaying Dialysis/SLED and CDX. Note: The blue CDX key will not switch to CDX during an alarm if blood is sensed and the Tx Clock is running.

Feature	Function
	The blue Fn (Function) Lock key selects the secondary function of keys with blue function numbers (F1-F12) at the top of the keyboard. Press the Fn Lock key and press a function key to select that function. Note: Older versions of the keyboard instead feature a Fn key which must be held down to select the secondary functions of the blue function number keys.
	The Fn Lock light in the upper left corner of the keyboard indicates the function lock status: when the light is on, the function lock is on. Press the Fn Lock key again to turn off the function lock.
	Caps lock light: Pressing the Caps lock key turns on the Caps lock light. When the Caps lock light is on, typing on the keyboard will display capital letters. Note: The Caps lock feature is not applicable when setting parameters in Dialysis or Service Mode.
Ctrl + Fn Lock + Z	Pressing the Ctrl , Fn Lock , and Z keys at the same time will cause the CDX system to restart
Control Panel Keys	Pressing the New Tx , UF on/off , Prime , Stat/Deflate , Mute , or Reset key on the control panel while displaying CDX will switch the machine back to Dialysis/SLED. The operator must then press the intended key again when in Therapy Mode to initiate that function.

Machine Connections

The 208T hemodialysis machine has two USB ports. USB port 1 is located on the right side of the monitor and protected with a flap (see Figure 106 on the next page). It is used for updating the hemodialysis machine software. Only the CLiC device should be connected to this USB port when the machine is in Dialysis Mode.



Warning! Do not connect devices requiring an external AC power connection to the machine's USB ports (for example: printers, card readers, or USB hard drives that plug into a wall outlet). Only freestanding (self-powered) devices such as USB flash drives are permitted. Inserting a powered USB device into your machine's USB ports may adversely affect the machine's electrical safety and patient isolation.

USB port 2 is located on the back panel of the machine (see Figure 107). It is used by the CDX system. Additionally, the back panel features an Ethernet port for the CDX PC.

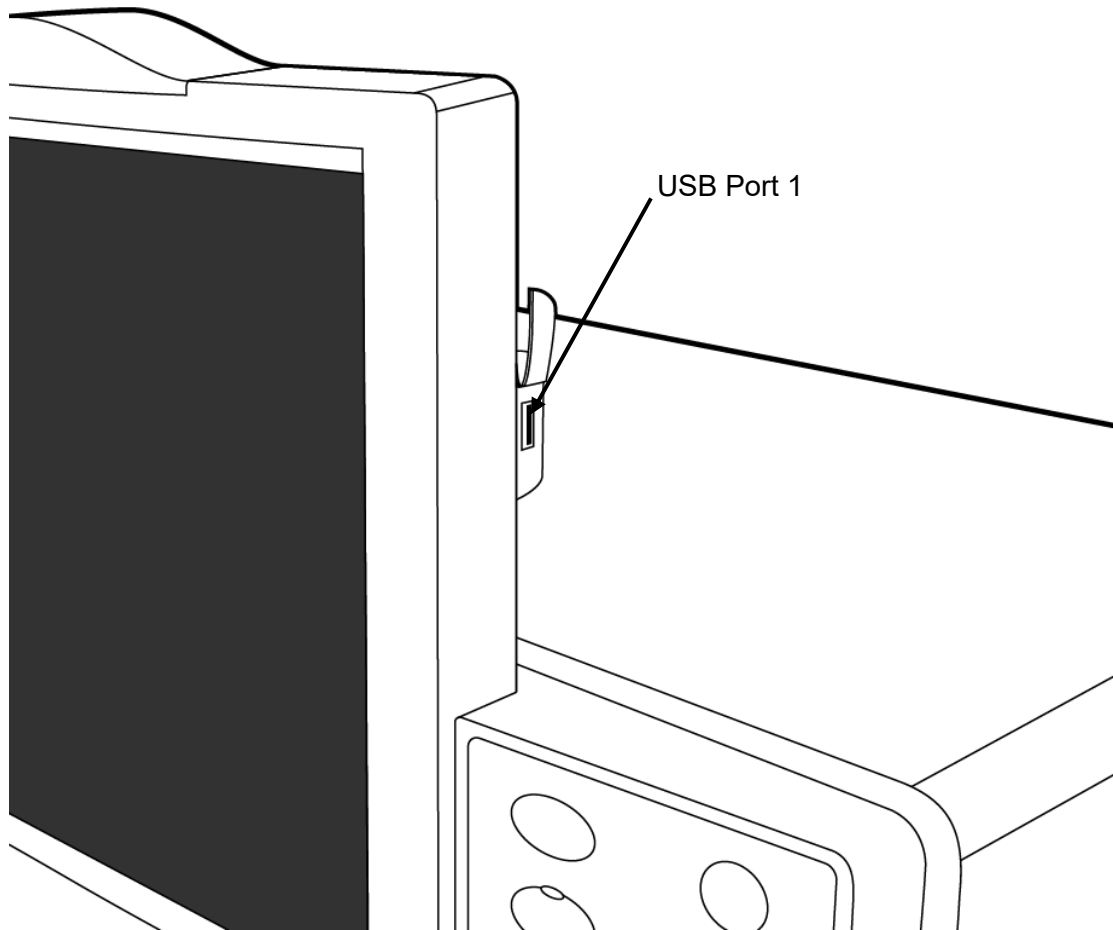

Figure 106 – USB Port 1 on Right Side of Display Screen

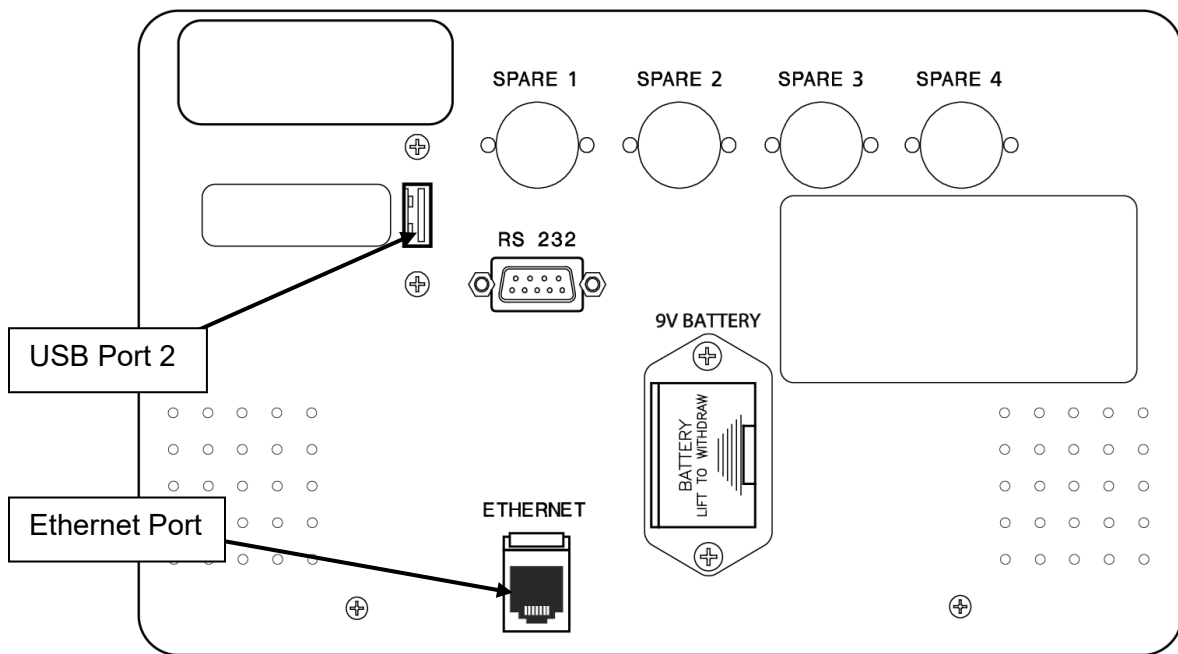

Figure 107 – CDX PC Access on the Back Panel

Instructions for Clinic Information Systems Personnel

The CDX system may be used to run various Medical Information Systems (MIS) normally housed outside of the 2008T hemodialysis machine and connected through its serial port. The CDX system houses that functionality inside the 2008T hemodialysis machine to reduce cabling and increase user convenience.



Note: The selection, installation, and maintenance of the MIS application is performed by the clinic. No MIS is sold as part of the 2008T hemodialysis machine. The operating system factory-installed on the 2008T hemodialysis machine is for testing purposes only.

Note: The clinic should have a paper patient treatment record or flow sheet available in the event of an MIS application failure.

Note: The CDX system can be scheduled to automatically power on and stay on for 24 hour periods. See “CDX Auto On” on page 347 for more information.

The installed MIS is unable to control the 2008T hemodialysis machine because the 2008T operates independently of the CDX system.

Operating System and Software Installation

The user of the CDX PC is responsible for installation of the operating system and application for clinical use. This may be installed by either of the following methods:



Caution: Refer to the 2008T Technicians Manual (P/N 490130) when accessing the 2008T hemodialysis machine electronics card cage.

- Booting from a USB drive, with the operating system pre-installed, connected to the USB port on the back panel (see Figure 107).
- Booting from a USB device to install an operating system image on the compact flash or mSATA solid state drive.

BIOS Management

The Basic Input/Output System (BIOS) of the CDX PC supports booting from many devices. If booting from anything other than the compact flash or mSATA solid state device is required, the boot order in the BIOS may need to be updated.

The default boot priority defined in BIOS is:

- 1) USB device
- 2) Storage device
- 3) PXE (Preboot Execution Environment)

The BIOS requires the user to enter a password before viewing or changing settings (see step 4 below).



Caution: Incorrectly altering the BIOS could result in the CDX PC not booting up properly. To recall factory BIOS settings, select the “Load Optimized Defaults” or the “Restore Defaults” in the BIOS.

To update the BIOS boot order for operating system installation

1. Press the **Power** key on the 2008T hemodialysis machine to start the machine. While on the “Select Program” screen, press the blue **CDX** key on the keyboard (see Figure 104). CDX will be displayed.
2. Press the **Ctrl + Fn Lock + Z** keys simultaneously to restart the CDX system.
3. Press the **DEL** key when prompted as the CDX system computer boots up.
4. Enter the BIOS password in the “Enter Password” window on the screen. On first use, enter the default password “Fmc123” and then change the Administrator’s password to enhance security. Using the arrow keys on the keyboard, navigate to the “Set Administrator Password” function and press Enter. The new password must have at least 3 and no more than 20 characters.



Figure 108 – Setting the Administrator Password



Caution: The BIOS password can be set to blank, which will remove this security feature until the password is reset.

5. Next, navigate to the “Boot” screen (the BIOS system does not allow touchscreen control).
6. Specify the first priority boot device, as required.
7. Once the boot order has been set, save the changes and restart the system to begin the installation process.

Installing MIS software on the CDX PC

After the operating system has been installed, the MIS software may be set up in a manner similar to a PC.

Data Storage

Data storage is on a removable mSATA or Compact Flash (CF) solid state drive (SSD) holding at least 4GB of data. The SSD appears as a standard hard drive to the CDX PC.



Note: SSDs are flash based storage and a wear out mechanism exists. SSDs contain internal features to wear level the writing to avoid premature failure. However, it would be advisable to keep writing to a minimum. Writing 5GB or less per day should not present a problem.

Also note that the 2008T hemodialysis machine may be powered off at any time. There is no requirement that the user do a PC shutdown before power is removed. Because of this, it is recommended that the operating system implemented be tolerant to this situation, or the operator should be instructed to shut down the operating system before shutting off power. The use of a read only operating system is recommended if the user will not shut down the operating system.

CDX PC Specifications for the Intel N3060 Processor

Operating System

Operating system	User installed (shipped with a Linux OS password, set as 'password') The CDX system supports 32 and 64 bit operating systems (Windows 7, Windows 10, and Linux)
BIOS	Boot from USB storage Boot from mSATA flash device Boot support for PXE boot (network boot)
Processor	Intel N3060 @ 1.6Ghz

Memory

RAM	DDR3 Memory, 4GB installed SO-DIMM module. Optional 8GB available as a spare part (P/N 362557-16).
Hard drive space	Removable 64GB flash-based memory for data storage of the operating system and other files. An optional 120GB mSATA card without an operating system installed is available as a spare part (P/N 390746).

Video Display

Display size	15"
Display resolution	1024 x 768, 18bits per pixel, LVDS output Video controller: Intel N3060 chipset
Chipset	Intel N3060 chipset, driver available at: www.intel.com

Audio

Speaker	Additional speaker on back panel
Codec	Realtek HD Audio, driver available at: www.realtek.com

Input Devices

Keyboard	Hardwired PS/2 connection
Touchpad	Hardwired PS/2 connection
Touchscreen	ELO touchscreen single-touch protocol. Hardwired to COM2. Driver available at: www.elotouch.com

Connections

USB	USB 2.0 port on back of machine Note: Any hardware expansion to the system will require the use of USB devices. More USB connections are available by adding a self-powered USB hub.
Wired Network	10/100 Ethernet with medical grade isolation: Realtek chipset 8105 Driver available at: www.realtek.com
Wireless Network	IEEE802.11a/b/g/n dual band, supports 64/128-bit WPA, WPAPSK, WPA2, and WPA2-PSK. RT3572 and RT5572 USB chipsets. Driver available at: www.mediatek.com
Serial	COM1: Connects to the 2008T functional processor board to support data transfer from the 2008T hemodialysis machine to the CDX PC. COM2: For use with the touchscreen

Additional Drivers

Most operating systems will install the necessary hardware drivers automatically. Drivers are also available at: www.aaeon.com, under the XTX-BSW product.

CDX PC Specifications for the Intel Atom D525 Processor

Operating System

Operating system	User installed (shipped with a Linux OS password, set as 'password') The CDX system supports 32 and 64 bit operating systems (Windows XP, Windows XP embedded, Windows 7, Windows 8, and Linux)
BIOS	Boot from USB storage Boot from compact flash device Boot support for PXE boot (network boot)
Processor	Intel Atom D525 @ 1.8Ghz, Intel ICH8M chipset

Memory

RAM	DDR3 Memory, 4GB installed SO-DIMM module
Hard drive space	Removable 32GB Compact Flash based memory for data storage of the operating system and other files. An optional 64GB Compact Flash card (P/N 362650-64) without an operating system installed is also available. Please contact the Fresenius Medical Care Spare Parts department or your sales representative for more information and pricing.

Video Display

Display size	15"
Display resolution	1024 x 768, 18bits per pixel, LVDS output Video controller: Intel D525 chipset
Chipset	Intel D525 chipset, driver available at: www.intel.com

Audio

Speaker	Additional speaker on back panel
Codec	Realtek HD Audio, driver available at: www.realtek.com

Input Devices

Keyboard	Hardwired PS/2 connection
Touchpad	Hardwired PS/2 connection
Touchscreen	ELO touchscreen single-touch protocol. Hardwired to COM2. Driver available at: www.elotouch.com

Connections

USB	USB 2.0 port on back of machine, additional port on PC board Note: Any hardware expansion to the system will require the use of USB devices. More USB connections are available by adding a self-powered USB hub.
-----	--

Wired Network	10/100 Ethernet with medical grade isolation: Realtek chipset 8103 or 8105 Driver available at: www.realtek.com
Wireless Network	IEEE802.11b/g/n dual band, supports 64/128-bit WEP, WPA, WPAPSK, WPA2, WPA2-PSK. RT3572 USB chipset. Driver available at: www.mediatek.com
	 Caution: Use of WEP is not recommended and could cause data to be compromised and impact patient privacy. It is the responsibility of the clinic to ensure that CDX communication is appropriately secured.
Serial	COM1: Connects to the 2008T functional processor board to support data transfer from the 2008T hemodialysis machine to the CDX PC. COM2: For use with the touchscreen

Drivers

All drivers (except for the touchscreen) are available at www.aaeon.com, under the ETX-LN product, or at www.advantech.com under the SOM-4463B1 product; touchscreen driver available at www.elotouch.com

CDX PC Specifications for the Intel Atom N270 Processor

Operating System

Operating system	User installed (shipped with a Linux OS password, set as 'password') The CDX system supports Windows XP, Windows XP embedded, Windows 7, Windows 8 (32-bit), and Linux operating systems
BIOS	Boot from USB storage Boot from compact flash device Boot support for PXE boot (network boot)
Processor	Intel Atom N270 Processor @ 1.6Ghz Intel 945GSE chipset

Memory

RAM	DDRII 533 Memory, 1GB minimum SO-DIMM module
Hard drive space	Removable 4GB or 16GB (at least 4,017,807,360 bytes) Compact Flash based memory for data storage of the operating system and other files.

Video Display

Display size	15"
Display resolution	1024 x 768, 18bits per pixel, LVDS output Video controller: Intel 945GSE chipset
Chipset	Intel 945GSE chipset Driver available at: www.intel.com

Audio

Speaker	Additional speaker on back panel
Codec	Realtek AC97 Driver available at: www.realtek.com

Input Devices

Keyboard	Hardwired PS/2 connection
Touchpad	Hardwired PS/2 connection
Touchscreen	ELO touchscreen protocol Driver available at: www.elotouch.com

Connections

USB	USB 2.0 port on back of machine, Note: Any hardware expansion to the system will require the use of USB devices. More USB connections are available by adding a self-powered USB hub.
Wired Network	10/100 Ethernet with medical grade isolation: The Intel Ethernet adapter is part of the 945GSE chipset. Intel 82562 physical layer interface Driver available at: www.intel.com
Wireless Network (one of the following)	IEEE802.11b/g, supports 64/128-bit WEP, WPA, WPA-PSK, WPA2, WPA2-PSK. RT73/RT257x USB chipset. Or IEEE802.11b/g/n dual band, supports 64/128-bit WEP, WPA, WPAPSK, WPA2, WPA2-PSK. RT3572 USB chipset. Driver available at: www.mediatek.com
Serial	COM1: Connects to the 2008T functional processor board to support data transfer from the 2008T hemodialysis machine to the CDX PC. COM2: For use with the touchscreen

Additional Drivers

Most operating systems will install the necessary hardware drivers automatically. Drivers are also available at: www.aaeon.com, under the XTX-945GSE product

CDX System Disclaimer

LIMITED WARRANTY. FRESenius MEDICAL CARE WARRANTS THAT THE CDX SYSTEM WILL PERFORM SUBSTANTIALLY IN ACCORDANCE WITH THE OPERATIONAL FEATURES OF ITS PUBLISHED SPECIFICATIONS AT THE TIME OF SALE, UNDER NORMAL USE IN ACCORDANCE WITH THIS OPERATOR'S MANUAL, AND FOR A PERIOD OF 180 DAYS FROM THE DATE OF INVOICE UNLESS OTHERWISE AGREED TO BY THE PARTIES. FRESenius MEDICAL CARE DISCLAIMS ANY AND ALL OTHER WARRANTIES FOR THE CDX SYSTEM, WHETHER EXPRESS OR IMPLIED, INCLUDING BUT NOT LIMITED TO THE IMPLIED WARRANTIES OF MERCHANTABILITY AND FITNESS FOR A PARTICULAR PURPOSE, ACCURACY, NON-INFRINGEMENT, NON-INTERFERENCE, COMPATIBILITY WITH SOFTWARE PROGRAMS, INTEGRATION, AND THOSE ARISING FROM COURSE OF DEALING, COURSE OF TRADE, OR ARISING UNDER STATUTE. FRESenius MEDICAL CARE DOES NOT WARRANT THAT THE CDX SYSTEM WILL PERFORM AT A PARTICULAR SPEED OR DATA THROUGHPUT RATE, OR WILL BE UNINTERRUPTED, ERROR-FREE, SECURE, OR FREE OF VIRUSES, WORMS, DISABLING CODE OR CONDITIONS, OR THE LIKE. FRESenius MEDICAL CARE SHALL NOT BE LIABLE FOR LOSS OF DATA, OR IF CHANGES IN OPERATION, PROCEDURES, OR SERVICES REQUIRE MODIFICATION OR ALTERATION OF THE CDX SYSTEM, RENDER THE SAME OBSOLETE OR OTHERWISE AFFECT ITS PERFORMANCE.

LIMITATION OF LIABILITY. IN NO EVENT WILL FRESenius MEDICAL BE LIABLE FOR ANY DAMAGES, INCLUDING WITHOUT LIMITATION DIRECT OR INDIRECT, PUNITIVE, SPECIAL, INCIDENTAL, OR CONSEQUENTIAL DAMAGES, LOSSES OR EXPENSES

ARISING IN CONNECTION WITH THE CDX SYSTEM OR USE THEREOF OR INABILITY TO USE BY ANY PARTY, OR IN CONNECTION WITH ANY FAILURE OF PERFORMANCE, ERROR, OMISSION, INTERRUPTION, DEFECT, DELAY IN OPERATION OR TRANSMISSION, COMPUTER VIRUS OR SYSTEM FAILURE, EVEN IF FRESENIUS MEDICAL CARE, OR REPRESENTATIVES THEREOF, ARE ADVISED OF THE POSSIBILITY OF SUCH DAMAGES, LOSSES OR EXPENSES. USE OF SOFTWARE IN CONJUNCTION WITH THE CDX SYSTEM IS AT PURCHASER'S RISK.

Concentrate Types

The 2008T hemodialysis machine is a three-stream dialysate delivery machine: it mixes the dialysate from three different sources: purified (RO) water, acid concentrate, and bicarbonate concentrate. The bicarbonate source can either be a liquid or a dry bicarbonate powder from the *bi*bag disposable. The 2008T hemodialysis machine is configured by acid concentrates; the bicarbonate concentrate dilution type is paired to the selected acid concentrate.



Caution: Use of a concentrate not found in the machine's concentrate list may cause damage to machine components. It is the responsibility of the clinic to validate any unlisted concentrate that is used in the 2008T hemodialysis machine.

For Functional Software Versions 2.72 or later

To check what functional software version your machine has, power up the machine and go to the "Select Program" screen. Look for this display at the lower left of the screen:

Apps Installed: Auto Heat, CDX
Software Versions: Functional 2.72
 Actuator X.XX

If your functional software version is 2.72 or later, your 2008T hemodialysis machine is configured for 45x concentrates only. Both bicarbonate concentrate and acid concentrate must be connected to the machine.

If your functional software version is 2.69 or earlier, turn to the next page for concentrate information.

The table below provides instructions on the proper mixture ratios for 45x concentrates.

Table 39 – Concentrates Data for machines with functional software versions 2.72 or later

	Base Mix Ratio Acid : Bicarb : Water : Total	Na ⁺ @ base mix ratio	Bicarbonate @ base mix ratio after reaction	Acid Concentrate Mix Ratio Acid : Other	Bicarbonate Concentrate Mix Ratio Bicarbonate : Other	Sodium Bicarbonate Concentrate composition
45X ▲	1 : 1.72 : 42.28 : 45	137 mEq/l	33 mEq/l (37-4)	1 : 44	1 : 25.16 (Bic = 81.25g/L)	81.25 g/L or 79.25 g/L or 72 g/L NaHCO ₃

For Functional Software Versions 2.69 or earlier

To check what software version your machine has, power up the machine and go to the “Select Program” screen. Look for this display at the lower left of the screen:

Apps Installed: Auto Heat, CDX
Software Versions: Functional 2.69
 Actuator X.XX

If your functional software version is 2.69 or earlier, your 2008T hemodialysis machine can be set up for various concentrate types. If a bicarbonate-type concentrate is to be used, both bicarbonate concentrate and acid concentrate must be connected to the machine. The table on the next page provides more information about mixing ratios.

If your functional software version is 2.72 or later, turn to the previous page for concentrate information.



Warning! Acetate concentrates are used individually with the machine. No bicarbonate concentrate is used. The 2008T hemodialysis machine is a standard 1:34 proportioning machine. When it is at a facility that uses 1:44 acid, be sure to use the keys and labeling as indicated. Use of 1:44 acid with a 1:34 acetate machine may cause patient injury or death.

Warning! Use of an acid concentrate intended for a 1:44 mix ratio in any 1:34 proportioning dialysate delivery machine may result in a dialysate solution with a normal conductivity but without a physiological buffer. There may be no alarms in this event. Use of this improper dialysate solution may cause patient injury or death.

The specific bicarbonate type is selected in Service Mode during calibration. For more information on selecting concentrate types, see “Enter Conc Screen: Selecting and Adding Concentrates” on page 332.





For more information on *bibag* bicarbonate concentrate run times, see “Estimated *bibag* disposable run times (minutes)” on page 313.



Warning! The machine must be labeled to indicate the type of concentrate for which it is configured. Check the composition (i.e., Na, Cl, K, Ca, Mg, HCO₃) and pH of the dialysate solution after the machine is installed or after the machine is modified for different concentrate types. Check the conductivity and approximate pH of the dialysate solution with an independent device before initiating dialysis. Independent means could be by using an external conductivity meter, pH meter, pH paper or by using the machine’s independent conductivity test. Improper conductivity or pH could result in patient injury or death.

The table below provides a data reference for ensuring the compatibility of the concentrates selectable for versions 2.69 and earlier and instructions on the proper mixture ratios.

Table 40 – Concentrates Data for machines with functional software versions 2.69 or earlier

	35X 	36.83X (Salt Spiked Bicarbonate) 	36.1X 	45X 	Acetate
Base Mix Ratio Acid : Bicarb : Water : Total	1 : 1.23 : 32.77 : 35	1 : 1.83 : 34 : 36.83	1 : 1.26 : 33.84 : 36.1	1 : 1.72 : 42.28 : 45	(Acetate : Water) 1 : 34 : 35
Na ⁺ @ base mix ratio	138 mEq/l	138 mEq/l	138 mEq/l	137 mEq/l	N/A
Bicarbonate @ base mix ratio after reaction	32 mEq/l (35-3)	35 mEq/l (39-4)	32 mEq/l (36-4)	33 mEq/l (37-4)	N/A
Acid Concentrate Mix Ratio Acid : Other	1 : 34	1 : 35.83	1 : 35.1	1 : 44	1 : 34
Bicarbonate Concentrate Mix Ratio Bicarbonate : Other	1 : 27.46	1 : 19.13	1 : 27.6	1 : 25.16 (Bic = 81.25g/L)	N/A
Sodium Bicarbonate Concentrate composition	84.0 g/L NaHCO ₃	65.95 g/L NaHCO ₃ + 23.53 g/L NaCl	84.0 g/L NaHCO ₃	81.25 g/L or 79.25 g/L or 72 g/L NaHCO ₃	<u>None</u>

Estimated bibag disposable run times (minutes)

The bibag disposable contains a fixed volume of bicarbonate powder. Refer to the tables below to make sure enough run time* (including any set-up time and potential pre-treatment delays) is available to complete your treatment using one bag.

Table 41 – 650g bibag Disposable Estimated Run Time (Minutes)*

650g		Bicarbonate Setting (mEq/L or mmol/L)																
		40	39	38	37	36	35	34	33	32	31	30	29	28	27	26	25	24
Dialysate flow QD (mL/min)	800	180	185	189	195	200	206	212	218	225	232	240	248	257	267	277	288	300
	700	206	211	217	222	229	235	242	249	257	265	274	284	294	305	316	329	343
	600	240	246	253	259	267	274	282	291	300	310	320	331	343	356	369	384	400
	500	288	295	303	311	320	329	339	349	360	372	384	397	411	427	443	461	480
	400	360	369	379	389	400	411	424	436	450	465	480	497	514	533	554	576	600
	300	480	492	505	519	533	549	565	582	600								
	200																	

Table 42 – 900g bibag Disposable Estimated Run Time (Minutes)*

900g		Bicarbonate Setting (mEq/L or mmol/L)																
		40	39	38	37	36	35	34	33	32	31	30	29	28	27	26	25	24
Dialysate flow QD (mL/min)	800	240	246	253	259	267	274	282	291	300	310	320	331	343	356	369	384	400
	700	274	281	289	297	305	313	323	332	343	354	366	378	392	406	422	439	457
	600	320	328	337	346	356	366	376	388	400	413	427	441	457	474	492	512	533
	500	384	394	404	415	427	439	452	465	480	495	512	530	549	569	591		
	400	480	492	505	519	533	549	565	582	600								
	300																	
	200																	

* Run times are estimates and may vary per unit protocol. Run times include estimated preparation and treatment time. Highlighted run times indicate more than 10 hours of treatment time.

** To estimate run times for bicarbonate settings lower than what is listed in the table, use a bicarbonate selection of 24 (mEq/L or mmol/L).

Service Mode



Note: This section describes features in Service Mode. It is strongly recommended that you contact a qualified service technician if any Service Mode changes must be made.

Note: Beginning in functional software version 2.81, a password is needed to enter Service Mode. See the “Manage User” section on page 354 for details.

Note: Beginning in functional software version 2.72, the fourth Service Mode screen button from the left is displayed as **Maint.** instead of **Calibrate Monitor**.

Appendix E provides instructions on different features and options set in Service Mode. This section is organized by screens and includes the following:

- Treatment Options, page 315
- Hardware Options, page 320
- Default Settings, page 323
- Auto Heat Disinfection (functional software version 2.69 or earlier), page 330
- Enter Conc: Selecting and Adding Concentrates, page 332
- UF Profile: Creating Custom UF Profiles, page 338
- Module Options, page 339
- Scheduler Screen features, page 341
 - Auto Heat Disinfect (functional software version 2.72 or later), page 343
 - Auto Start (functional software version 2.72 or later), page 345
 - CDX Auto On (functional software version 2.72 or later), page 347
 - PM (Preventive Maintenance) Reminder, page 349
 - Diasafe Maintenance Reminder, page 352
- Other Options, page 358
- Testing the Dialysate, page 359
- Equipment Storage and Maintenance, page 361
- Machine Specifications, page 362
- Manufacturer’s EMC Declaration, page 375
- Product Improvement Policy, page 379
- Warranty, page 379

For a description of Service Mode calibration procedures, see the following documents:

- 2008T Technicians Manual (P/N 490130)
- 2008T Calibration Procedures Manual (P/N 508032)
- 2008T Preventive Maintenance Procedures Manual (P/N 508033)

Treatment Options Screen

The screenshot shows the 'Treatment Options' screen with a green header. The settings are organized into several sections:

- Forced Test:** Yes No
- Spread Limits:** Yes No
- Auto BP Reading:** Clock Interval
- Auto Flow Minimum:** 300 500
- Auto Flow Selection:** None
- Allow Slow Flow:** Yes No
- Plasma Na+:** Hide Show
- Heparin Dwell:** Yes No
- Kt/V Tolerance:** 0% 15%
- Default Dial Flow:** 800
- SVS:** Yes No
- Idle Mode Flow Rate:** 100 300
- Auto Prime:** Yes No
- Kt/V Default:** 1.40
- Language:** English
- Arterial Limits:** 120
- Venous Limits:** 100 Asymmetric
- Asymmetric Venous Limits:** 30 mmHg
- Assisted Reinfusion:** Yes No
- Cond Alarm Position:** Locked Unlocked

Navigation buttons at the bottom include: Treatment Options, Hardware Options, Comm Options, Default Settings, Enter Conc, Transfer Data, UF Profile, Module Options, Options, Calibrate Hydraulics, Calibrate Sensors, Maint., BP Module, Diagnostics, Fill for Shipping, and Update Software.

Figure 109– Treatment Options Screen (showing functional software version 2.81 or later and 2008T BlueStar Premium)

Forced Test

If this option is set to ‘Yes’, upon power up and selecting Dialysis or SLED (except after a power failure or short power down), the machine will be in Standby. In Standby, the blood pump does not run (except for Prime and Level Adjust). The ultrafiltration and Sodium Variation System cannot be turned on. The low priority message “Standby for Test” is displayed in the Status Box.

The test sequence will automatically start 30 seconds after the test criteria have been met. Standby ends with the initiation of the test (whether by the operator or automatically).

Spread Limits

If this option is set to ‘Yes’, and no blood leak alarm exists, the **Reset** key can be used to spread the arterial and venous alarm limits by 300 mmHg for 30 seconds. The TMP alarm limits will completely open. After 30 seconds the limits will reset around the current pressure readings.

Auto Blood Pressure Reading

This option is used to choose between displaying ‘Interval’ and ‘Clock Time’ on the Dialysis/SLED “Blood Pressure” screen to determine when to take a blood pressure reading. With ‘Interval’ selected, the readings occur at the time interval selected. With ‘Clock Time’ selected, the blood pressure is taken at specified times (e.g. every half hour on the hour and half hour).

Auto Flow Minimum

The Auto Flow Minimum option selects the dialysate flow rate during dialysis when Auto Flow is selected: 300 – 800 ml/min or 500 – 800 ml/min (default selection).

Auto Flow Selection

There are four available choices for Auto Flow in dialysis:

- **Both**—The operator can scroll to either 1.5x or 2x (default selection)
- **1.5X**—The operator only has a choice of 1.5x (plus the normal flow rates)
- **2.0X**—The operator only has a choice of 2x (plus the normal flow rates)
- **None**—The operator cannot choose any Auto Flow options

See the blood flow rate table on page 364 for more information.

Allow Slow Flow

The Allow Slow Flow option allows the machine to run dialysate flows of 100, 150 or 200 ml/min. This feature requires a special temperature calibration. Please refer to the 2008T Hemodialysis System Calibration Procedures manual (P/N 508032).

Plasma Na⁺ (functional software version 2.72 or later)

This option is used to either show or hide the Plasma Na⁺ meter box on the Dialysis program “OLC Data” subscreen.

Heparin Dwell

The Heparin Dwell option displays the Heparin Dwell button on the “Heparin” screen. The button acts as a five minute timer; after a manual heparin bolus is administered and the operator selects and confirms the Heparin Dwell button, causing the yellow Status Light to flash for five minutes while the heparin is dwelling.

Kt/V Graph Tolerance

Either a 0% or a 15% tolerance from the target Kt/V is selectable in Service Mode. If 15% is selected and the projected Kt/V is less than 85% of the target, the operator will be alerted. If

0% is selected and the projected Kt/V is less than 100% of the target, the operator will be alerted.

Default Dial Flow

The **Default Dial Flow** button is used to set the default dialysate flow rate in the machine runs after exiting Idle Mode (if 1.5x or 2x Auto Flow was not set). The choices are: 500, 600 (functional software version 2.72 or later), 700 (functional software version 2.72 or later), or 800 ml/min. The user is then free to set the prescription.

SVS (functional software version 2.34 or later)

The SVS (Sodium Variation System) feature may be enabled or disabled.

Idle Mode Flow Rate

Regardless of Auto Flow selections, the machine will take control of the dialysate flow during idle periods. For functional software version 2.72 or later with 2008T BlueStar Premium, the machine will run dialysate flow at either 100 or 300 ml/min, depending on the setting chosen in Service Mode; for functional software version 2.69 or earlier, or without 2008T BlueStar Premium, the rate is always 300 ml/min.

Idle Mode will be engaged in the following situations:

- A long power down, rinse, disinfect, or self-test has just occurred and the blood pump has been off for 30 seconds
- The New Tx key is pressed and confirmed and no dialysate flow rate has been set
- Saline recirculation is complete and treatment has not yet started (i.e. the Tx Clock has not yet started and blood is not sensed); the blood pump may continue to run without cancelling Idle Mode
- Tx has ended (i.e., RTD counted to 0 and blood not sensed)

Idle Flow is cancelled when:

- The blood pump is turned on with the **Start/Stop** key
- A new dialysate flow rate is selected
- Conductivity is outside limits
- Treatment has started (i.e., RTD > 0 or blood is sensed). The dialysate flow will then be the selected default dialysate flow (see above) or what the operator has entered on the “Home” screen.

Note: Idle Mode requires special temperature calibrations. Please refer to the 2008T Hemodialysis System Calibration Procedures manual (P/N 508032).

Auto Prime (functional software version 2.72 or later with 2008T BlueStar Premium)

Setting this option to 'Yes' will display the **Auto Prime** button on the "Test & Options" screen to aid the operator in priming the bloodlines before treatment. **Note:** This option is not selectable when the Service Mode "Hardware Settings" screen 'Arterial Chamber' setting is set to 'Post'.

Note: The 'Auto Prime' option is part of 2008T BlueStar Premium. Contact the Fresenius Medical Care Spare Parts department or your sales representative for more information and pricing.

Kt/V Default

The default Kt/V (target or minimum value) is selectable between 0.40 and 1.40.

Assisted Reinfusion (functional software version 2.72 or later with 2008T BlueStar Premium)

Setting this option to 'Yes' will display the **Assisted Reinfusion** button on the "Test & Options" screen to assist the operator in returning the patient's blood at the end of treatment.

Note: This option is not selectable when the Service Mode "Hardware Settings" screen 'Arterial Chamber' setting is set to 'Post'.

Note: The 'Assisted Reinfusion' option is part of 2008T BlueStar Premium. Contact the Fresenius Medical Care Spare Parts department or your sales representative for more information and pricing.

Language

The language of the Dialysis/SLED screens may be set so that they are in French (Canada), Spanish (Mexico) or English (USA). Service Mode is always in English.

Arterial Limits

This option is used to select the width of the arterial pressure alarm limit window. The window may be set to a fixed width for all treatments or the user may be allowed to set the limits for each treatment in the Dialysis/SLED "Test & Options" screen by selecting 'User Selectable' here. Otherwise, the arterial window may be set to a total width of 120, 160, or 200 mmHg. The lowest value that does not cause frequent nuisance alarms should be chosen.

Venous Limits

This option is used to select the width of the venous pressure alarm limit window. The window may be set to a fixed width for all treatments or the user may be allowed to set the limits for each treatment in the Dialysis/SLED “Test & Options” screen by selecting ‘User Selectable’ here. Otherwise, the venous window may be set to a total width of 100 asymmetric, 120, 160, or 200 mmHg. If 100 asymmetric limits are chosen, the lower venous limit will tighten to the selected value after a short time delay. This value is selected with the “100 Asymmetric Limits” option below. The lowest value that does not cause frequent nuisance alarms should be chosen.

Asymmetric Venous Limits

This option is paired with the Venous Limits: 100 Asymmetric option above. The choices are 20, 25, 30, 35 mmHg. The lowest value that does not cause frequent nuisance alarms should be chosen.

Cond Alarm Position (functional software version 2.72 or later)

Setting this button to ‘Locked’ grays out the Conductivity Alarm Position button on the Dialysis/SLED “Dialysate” screen, making it unavailable to adjust the Conductivity Alarm Window position.

Hardware Options Screen

The screenshot shows the 'Hardware Options' screen with a green header. The main area contains several settings, each with a 'Yes' and 'No' radio button. The 'Online PHT' setting is checked under 'No'. The 'Audible Alarm' setting is checked under 'No'. The 'Beacon' setting is set to 'Alarm'. The 'OLC' setting is checked under 'Yes'. The 'Arterial Chamber' setting is checked under 'Post'. The 'T and C Mode' setting is checked under 'No'. The 'Use CMS208K' setting is checked under 'No'. The 'Diasafe Filter' setting is checked under 'Yes'. The 'Diasafe Auto-Test' setting is checked under 'Yes'. The 'O Art Limit' setting is checked under 'No'. The 'Dialysate Sampling' setting is checked under 'No'. The 'Heparin Pump' setting is checked under 'Yes'. The 'Temp Comp.' setting is checked under 'No'. The 'HE Leak Test' setting is checked under 'No'. The 'Independent Cond Test' setting is checked under 'Yes'. Below the settings are two rows of navigation buttons. The first row includes 'Treatment Options', 'Hardware Options' (highlighted), 'Comm Options', 'Default Settings', 'Enter Conc', 'Transfer Data', 'UF Profile', and 'Module Options'. The second row includes 'Options', 'Calibrate Hydraulics', 'Calibrate Sensors', 'Maint.', 'BP Module', 'Diagnostics', 'Fill for Shipping', and 'Update Software'.

Figure 110 – Hardware Settings Screen (showing functional software version 2.81 or later)

Online PHT

The online pressure holding test (PHT) is enabled or disabled with this button. The Online PHT verifies the integrity of the machine’s hydraulics every twelve minutes during treatment. It lasts about seven seconds, depending on the dialysate flow rate (two cycles of the balancing chamber). This is necessary for accurate fluid balance and UF control and does not replace the ‘Pressure Test’ self-test on the Dialysis/SLED “Test & Options” screen. The Online PHT must be selected in Service Mode and the ‘Online PHT’ option is mandatory (set to ‘Yes’ and grayed-out) when the *bi*bag module is installed. See “Online Pressure Holding Test” on page 165 for more information.

Arterial Chamber

This option is used to define whether the arterial chamber is pre-pump or post-pump. The range of the display is different depending on the location of the chamber. **Note:** The ‘Auto Prime’ and ‘Assisted Reinfusion’ options are not available if the ‘Arterial Chamber’ option is set to ‘Post’ pump.

Diasafe Auto-Test

This option is used to choose whether or not to display the Diasafe Test on the Dialysis/SLED “Test & Options” screen.

Temp Comp.

This option is used to enable or disable the temperature compensation option.

Audible Alarms

This option may be set so that audible alarms do not occur in certain situations. With “Yes” set, audible alarms will occur in any alarm situation when either blood is sensed in the venous bloodline or the lines are off the shunt. If “No” is selected, audible alarms only occur when blood is sensed. **Note:** Regardless of this setting, the machine responses, such as bypass or blood pump and venous clamp operation are unaffected.

T and C Mode

This is for manufacturing operations only and should never be selected by the facility.

0 Arterial Limit

With this option set to yes, the upper arterial limit cannot be above 0 (with pre-pump arterial monitoring only) when blood is sensed unless the spreading limits function is active.

HE Leak Test (functional software versions 2.53 and later)

Setting the HE (Heat Exchanger) Leak Test option to ‘Yes’ will run a four minute pressure holding test on the Heat Exchanger after the Chemical/Rinse program’s 45 second pre-rinse.

Beacon (Status Light)

There are four possible selections for this option: Alarm, FDS08, OLC, and Status:

- With “Alarm” selected, the red light acts the same as the audible High Alarm. The yellow light illuminates when Low Alarms occur. The green light is illuminated when there are no alarms.
- With “FDS08” selected, the red light acts the same as the audible alarm. The yellow and green light illumination is based on a flag sent from a remote system connected to the RS-232 port.
- With “OLC” selected, the red light acts the same as the audible alarm. The yellow light is illuminated when the projected Kt/V is less than 100% of the target Kt/V (depending on selected Service Mode option). The Green light is illuminated if there are no alarms, and the necessary OLC parameters have been set (Volume, Target Kt/V, and OLC enabled) and the Kt/V is projected to be at least 100% of target (depending on selected Service Mode option).
- With “Status” selected, the lights act the same as the Red/Yellow/Green indicator lights on the machine.

Use CMS208K

This button is not in use.

Dialysate Sampling

This option is used to display the Dialysate Sampling button on the Dialysis/SLED “Test & Options” screen. When this option is set to ‘Yes’, the operator may take an aliquot sample of the dialysate from the back of the machine during treatment.

Independent Cond Test (functional software version 2.72 and later)

This option is used to choose whether or not to independently verify the dialysate conductivity as part of the Dialysis/SLED “Test & Options” screen self-tests. If this option is set to ‘Yes’, the Independent Conductivity reading will be displayed on the “Dialysate” screen under the heading “Pre Tx Conductivity”. The ‘Independent Conductivity’ test will also be listed among the self-tests. When the *bi*bag disposable is used as the bicarbonate source for the treatment, the Independent Conductivity self-test will be displayed as ‘Independent Conductivity/pH’ and the machine will then independently verify the conductivity and pH during the self-test.

Selecting this option requires the Independent Conductivity Cell to be calibrated in Service Mode on the “Calibrate Sensors: Cond. Cells” screen.

OLC

This option is used to enable or disable the online clearance features functions on the Dialysis program “Kt/V AF” screen.

Diasafe Filter

This option defines whether or not a DIASAFE *plus*_{US} filter is present in the machine. As some of the timing of various functions is dependent on the volume in the filter, this option must be set properly.

Heparin Pump

When this option is set to ‘Yes’, the heparin pump settings are available to set on the Dialysis/SLED “Heparin” screen.

Comm Options Screen (functional software version 2.72 or later)

The screenshot shows the 'Communication Options' screen with the following settings:

- Machine Name:** [Empty text field]
- New Protocol:** Yes No
- CDX:** Yes No
- PC Debug:** Yes No
- Modem Commun:** Yes No
- Baud Rate:** 1200
- Phone Number for Modem Communication:**
 - Access #: 9
 - LD Prefix: 1
 - Area Code: 925
 - Ph. Prefix: 295
 - Ph. Number: 0200

Navigation buttons at the bottom include: Treatment Options, Hardware Options, **Comm Options** (highlighted), Default Settings, Enter Conc, Transfer Data, UF Profile, Module Options, Options, Calibrate Hydraulics, Calibrate Sensors, Maint., BP Module, Diagnostics, Fill for Shipping, and Update Software.

Figure 111 – Comm Options Screen (showing functional software version 2.81 or later)

Machine Name

Use the keyboard to enter the Machine Name. The Machine Name is the Machine ID that will be sent in the remote protocol. Press the **Enter** key on the keyboard to confirm the entry.

New Protocol

Each computer system connected to the 2008T requires the selection of one of two protocols. This button selects the type of remote protocol for the internal CDX PC and the RS232 serial port on the back panel. Toggle this button to 'Yes' to select Checksum Protocol or to 'No' to select Standard Protocol. Press the **Enter** key on the keyboard to confirm the selection.

CDX

Toggle this button to 'Yes' to enable communication to the CDX PC inside the 2008T. Select 'No' to enable communication instead through the RS232 serial port on the back panel.



Note: For software version 2.72 and later, only one serial connection is enabled. Should communications through the back RS232 serial port not work, or connection to the CDX be unsuccessful, check to make sure that the correct serial port is configured in service mode.

PC Debug, Modem Commun, Baud Rate, Phone Number for Modem Communication

These buttons are not currently in use.



Note: For software version 2.81 and later, when the concentrate list is sent by the remote protocol, the Ca++ value sent for concentrates with a Ca++ of 2.25 will be 2.2.

Comm Options Screen (functional software version 2.69 or earlier)

The screenshot shows the 'Communication Options' screen with the following settings:

- Machine Name: [Empty text box]
- New Protocol: Yes, No
- CDX New Protocol: Yes, No
- PC Debug: Yes, No
- Modem Commun: Yes, No
- Baud Rate: 1200
- Phone Number for Modem Communication:

Access #	LD Prefix	Area Code	Ph. Prefix	Ph. Number
9	1	925	295	0200

Navigation buttons at the bottom include: Treatment Options, Hardware Options, **Comm Options**, Default Settings, Enter Conc, Transfer Data, UF Profile, Module Options, Options, Calibrate Hydraulics, Calibrate Sensors, Calibrate Monitor, Test BP Module, Diagnostics, Fill for Shipping, and Update Software.

Figure 112 – Comm Options Screen (showing functional software version 2.69 or earlier)

Machine Name

Use the keyboard to enter the Machine Name. The Machine Name is the Machine ID that will be sent in the remote protocol. Press the **Enter** key on the keyboard to confirm the entry.

New Protocol

Each computer system connected to the 2008T requires one of two protocols. This button selects the type of remote protocol for RS232 serial port on the back panel. Toggle this button to 'Yes' to select checksum protocol or to 'No' to select standard protocol. Press the **Enter** key on the keyboard to confirm the selection.

CDX New Protocol

Each computer system connected to the 2008T requires one of two protocols. This button selects the type of remote protocol for communications with the internal CDX PC. Toggle this button to 'Yes' to select checksum protocol or to 'No' to select standard protocol. Press the **Enter** key on the keyboard to confirm the selection.

PC Debug, Modem Commun, Baud Rate, Phone Number for Modem Communication

These buttons are not currently in use.

Default Settings Screen

The screenshot shows the 'Default Settings' screen with a green header. The screen is divided into several sections for setting different parameters:

- Acid Clean Time:** 60 min. Includes 'Ext. Pre-Rinse' checkbox (checked) and 'Yes/No' radio buttons (No selected).
- Rinse Time:** 60 min.
- Acid Alert Default:** 5.0 L. Includes 'Post Recirc Qb' checkbox.
- Heat Disinfect Time:** 60 min. Includes 'New Tx Rx Warning' checkbox (checked) and 'Yes/No' radio buttons (No selected).
- Recirc Goal:** 10 ml.
- Bic Alert Default:** 6.0 L.
- Chemical/Rinse Time:** 60 min. Includes 'Recirc Option' checkbox (checked) and 'Yes/No' radio buttons (No selected).
- Recirc Time:** 0:00 h.min.
- Max UF Rate:** 3000 ml/h.
- Chemical/Dwell Time:** 60 min. Includes 'Default Rx Screen' checkbox (checked) and 'Yes/No' radio buttons (No selected).
- Prime Amount:** 0 ml.
- LV Max UF Rate:** 1000 ml/h.

At the bottom, there are two rows of navigation buttons: Treatment Options, Hardware Options, Comm Options, Default Settings (highlighted), Enter Conc, Transfer Data, UF Profile, Module Options; and Options, Calibrate Hydraulics, Calibrate Sensors, Maint., BP Module, Diagnostics, Fill for Shipping, Update Software.

Figure 113 – Default Settings Screen (showing functional software version 2.81 or later)



Note: Starting in functional software version 2.72, the ‘Off after Heat Disin’ option is located on the “Maint.: Scheduler: Auto Heat Disinfect” screen.

Note: Refer to ANSI/AAMI 11663:2014 in order to determine appropriate heat and chemical disinfection cycle parameters

Acid Clean Time

This button selects the duration of the Acid Clean program. It can be set from 10 to 60 minutes in one minute increments.

Heat Disinfect Time

This button selects the duration of the Heat Disinfection program. It can be set from 10 to 60 minutes in one minute increments. **Note:** The default time is 20 minutes.

Chemical/Rinse Time

This button selects the duration of the Chemical/Rinse program. It can be set from 10 to 60 minutes in one minute increments.

Chemical/Dwell Time

This button selects the duration of the Chemical/Dwell program. It can be set from 10 to 60 minutes in one minute increments.

Extended Pre-Rinse

With this option set to yes, the pre-rinse time for heat disinfect is increased to 20 minutes with reduced flow and higher fluid temperature through the drain line.

Off After Heat Disin (functional software version 2.69 or earlier)

Note: Beginning in functional software version 2.72, this button is instead displayed on the “Maint.: Scheduler: Auto Heat Disinfect” screen, see page 342.

Set in the “Options: Default Settings” screen, the user may choose to automatically power down the machine after a Heat Disinfect program is run.

Rinse Time

This button selects the duration of the Rinse program. It can be set from 10 to 60 minutes in one minute increments. **Note:** The default time is 15 minutes.

Auto Heat Disinfection (functional software version 2.69 or earlier)

Note: Beginning in functional software version 2.72, this button is instead displayed on the “Maint.: Scheduler” screen, see page 342.

On the “Options: Default Settings” screen the user may select a start time (Start Prg), days of the week toggle-buttons, and a pre-rinse time to automatically run a Heat Disinfection program. This program affects only the start time of the Heat Disinfection, all other settings function as usual. With the machine on and set up for rinse, the Heat Disinfection program will run at the selected time(s). See page 330 for instructions on using the functional software version 2.69 or earlier of the Auto Heat Disinfection program.

Note: Requires special activation for this feature, contact Fresenius Medical Care Spare Parts department or your sales representative for more information and pricing.

Default Rx Screen (functional software version 2.72 or later)

With Default Rx Screen option set to yes, pressing and confirming the **New Tx** key in Dialysis program will display the “Default Parameters” screen (see page 119 for more information). There the operator may conveniently set treatment parameters, similar to how it is done with the optional 2008T BlueStar Premium PatientCard.

New Tx Rx Warning (functional software version 2.72 or later)

With New Treatment Prescription Warning option set to yes, pressing and confirming the **New Tx** key in Dialysis/SLED will prompt the user to individually confirm the acid concentrate and both the Base Na⁺ and Bicarbonate settings if they are not set to the nominal values.

Note: This option is disabled when a PatientCard is used to program the treatment.

Recirc Option

This option is used to enable or disable the Dialysis program recirculation function. When Recirculation is initiated, the preselected goal and time with the calculated rate will automatically display on the “Home” screen and start ultrafiltration. **Note:** If the Recirc Option is set to ‘Yes’, then the Recirc Goal and the Recirc Time must also be set.

Recirc Goal

If the Recirc Option is set to ‘Yes’, the recirculation volume may be set from 10 to 9990 ml in 10 ml increments. **Note:** this value affects the time of the Auto Prime recirculation.

Recirc Time

If the Recirc Option is set to ‘Yes’, the recirculation time may be set from 0 minutes to 9 hours 59 minutes in 1 minute increments. **Note:** this value affects the time of the Auto Prime recirculation.

Prime Amount

A prime volume from 0 to 1000 ml in 100 ml increments can be selected. This allows Prime to continue until the selected volume has been delivered (measured by the blood pump speed). Setting the prime amount to zero will run prime for two minutes or fluid has been detected by the level detector, whichever comes first.

Acid Alert Default

The operator may use this option to set the default acid concentrate jug volume to be displayed in the Dialysis/SLED “Dialysate” screen’s Acid/Bicarb Alert feature. The button may be set from 0.0 to 9.9 L in 0.1 L increments.

Bic Alert Default

The operator may use this option to set the default bicarbonate concentrate jug volume to be displayed in the Dialysis/SLED “Dialysate” screen’s Acid/Bicarb Alert feature. The button may be set from 0.0 to 9.9 L in 0.1 L increments.

Max UF Rate

The maximum UF rate is limited with this selection. The choices are 1000, 2000, 3000, 4000 ml/h.

LV Max UF Rate (functional software version 2.72 or later)

This selection limits the Low Volume maximum UF rate for a low volume patient's treatment. The choices are 500, 600, 700, 800, 900, and 1000 ml/h.

Post Recirc Qb (functional software version 2.81 or later)

This button allows the user to set a default value for the Blood Flow rate when recirculation is finished. The maximum and minimum allowable settings for each tubing diameter are given below, as well as the default value.

Blood Tube Diameter	Post Recirc Qb Minimum	Post Recirc Qb Maximum	Post Recirc Qb Default
2.6 mm	40 ml/min	60 ml/min	40 ml/min
4.8 mm	60 ml/min	100 ml/min	60 ml/min
6.35mm	100 ml/min	200 ml/min	100 ml/min
8 mm	100 ml/min	200 ml/min	100 ml/min

Auto Heat Disinfection (functional software version 2.69 or earlier)

The Auto Heat Disinfection option is a special feature* that allows the user to program the 2008T hemodialysis machine to automatically run a heat disinfection program according to a schedule. In the “Options: Default Settings” screen the user may select a start time (Start Prg) and any day(s) of the week toggle-button(s).

This program affects only the start time of the Heat Disinfect, all other settings function as usual. With the machine on and set up for rinse, the Heat Disinfect program will run at the selected time(s).



Note: If another rinse is running when the Auto Heat Disinfection is set to run, the Auto Heat Disinfection will start after the first rinse ends.

Setting Auto Heat Disinfection Times

1. Go to Service Mode and select the “Options: Default Settings” screen (see below).

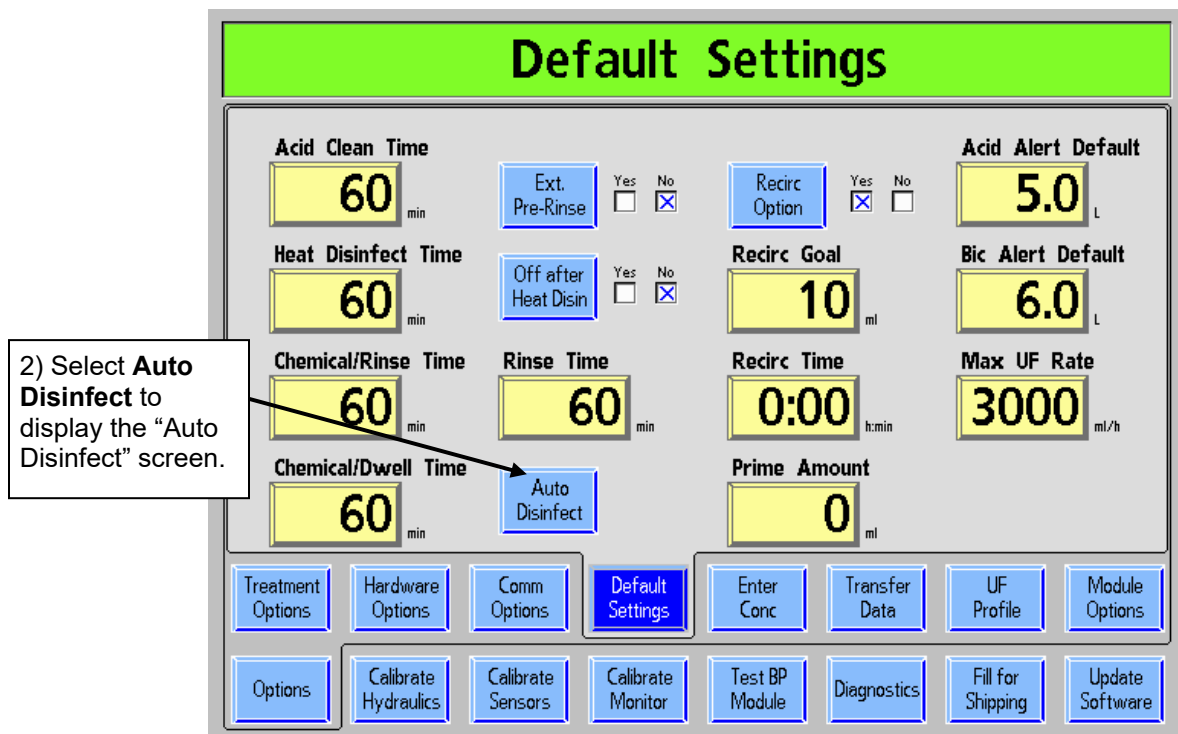

Figure 114 – Default Settings Screen (showing functional software version 2.69 or earlier)

* Prior to functional software version 2.72, the Auto Heat Disinfection feature is only available with kit P/N 190679. Contact the Fresenius Medical Care Spare Parts department or your sales representative for more information and pricing.

3) Select **Start Prg** and, using the keyboard, enter the time at which the Heat Disinfect should automatically begin.
Note: The clock is a 24 hour clock, so 0:00 is midnight and 13:00 is 1:00 PM.

4) Select the desired day(s) of the week button(s) on which the Auto Heat Disinfect should run. The blue X will change from Off to On, indicating the Heat Disinfect will run on that day at the specified time (set in the **Start Prg** button).

5) Select **Pre-Rinse Time** button and enter the desired time for a rinse that runs before the Auto Heat Disinfect program.
Note: The heater will be off during the pre-rinse.

6) Press **CONFIRM**.

Figure 115 – Setting Auto Heat Disinfection Schedule (showing functional software version 2.69 or earlier)

7. Exit Service Mode and go to the “Select Program” screen after powering on.
8. Ensure that both dialysate lines are on the shunt.
9. Place both concentrate connectors in their respective ports and leave the machine running while displaying the “Select Program” screen. The Auto Heat Disinfection program will automatically run at the selected time(s) when the dialysate lines are on the shunt and both concentrate connectors are in their respective ports.



Note: If the Service Mode option ‘Off after heat disin’ is set to ‘Yes’, the machine will automatically turn off after the Heat Disinfection program is complete. This includes Heat Disinfect programs that are manually selected.

Enter Conc Screen: Selecting and Adding Concentrates



Note: When updating the software from version 2.65 and earlier to version 2.72 (2008T BlueStar) or later, only 45x concentrates will be retained in the “Enter Conc” screen concentrate list. As 2008T BlueStar only supports 45x type concentrates, those that are not 45x will be deleted.

The 2008T hemodialysis machine is configured by acid concentrates; the bicarbonate concentrate dilution type is paired to the selected acid concentrate. Concentrates currently selected for use in Dialysis/SLED are listed on the Service Mode “Enter Conc” screen (see below). If a desired acid concentrate is not shown in the list, new acid concentrates can either be selected from a pre-programmed list or entered manually. To delete a concentrate from the list, see page 337.

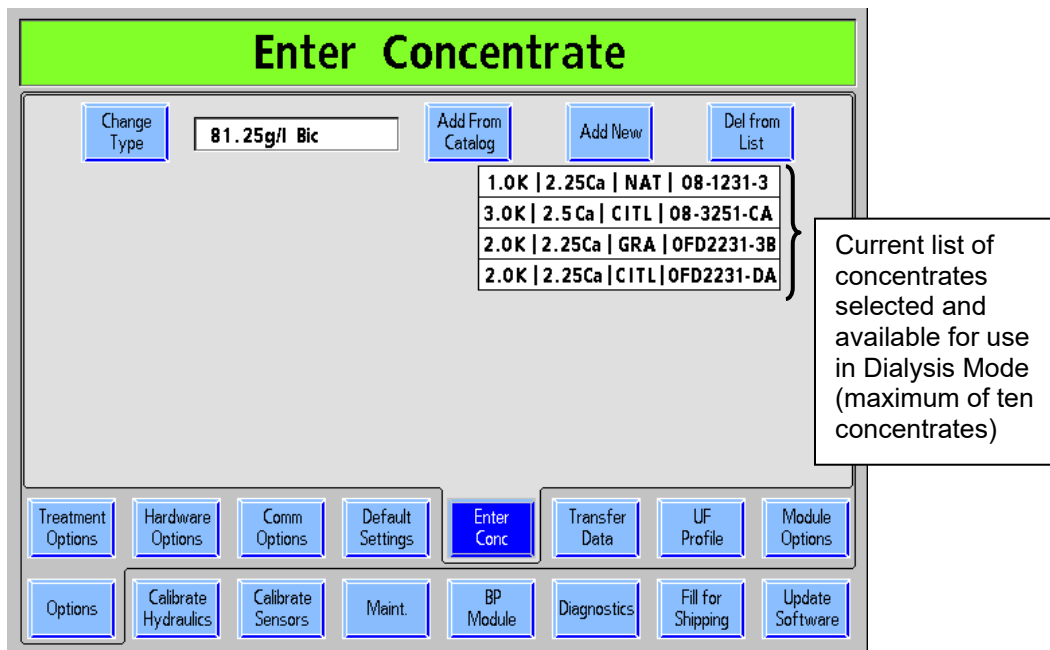

Figure 116 – Enter Conc screen with list of concentrates selected for Dialysis Mode (showing functional software version 2.81 or later)

To add a concentrate to the list, do the following:

1. Power the machine on into Service Mode by pressing the **CONFIRM** key when prompted during the power up sequence.
2. Select the **Options** screen-button and then select the **Enter Conc** screen-button to view the “Enter Concentrate” screen.
3. Verify that the correct type of concentrate is selected (functional software version 2.72 or later allows only 45x concentrates). If not, select **Change Type** and highlight the desired type using the **↑ / ↓** (up or down) keys located on the keyboard. Press the **CONFIRM** key to save your selection and exit the “Change Type” subscreen.

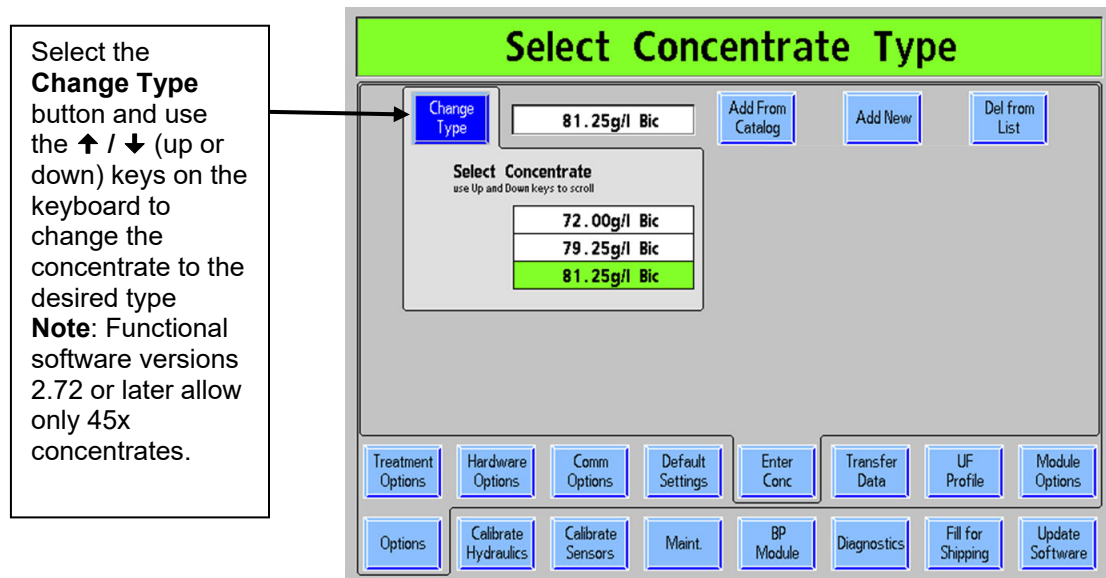

Figure 117 – Selecting the Concentrate Type (functional software version 2.81 or later)

4. To then add a concentrate from the selected type, do one of the following:
 - Select the **Add From Catalog** button if the acid concentrate is available in the pre-programmed list (see below) or
 - Select the **Add New** button and create a new acid concentrate setting manually (see the next page).

To add an acid concentrate from the pre-programmed catalog:

Select the **Add From Catalog** button. A list of the pre-programmed acid concentrates for the selected concentrate type will appear (see Figure 118 below). Highlight the desired acid concentrate by using the **↑ / ↓** (up or down) keys on the keyboard and then press the **CONFIRM** key. The acid concentrate will now appear in the “Enter Conc” screen concentrate list (see page 245).

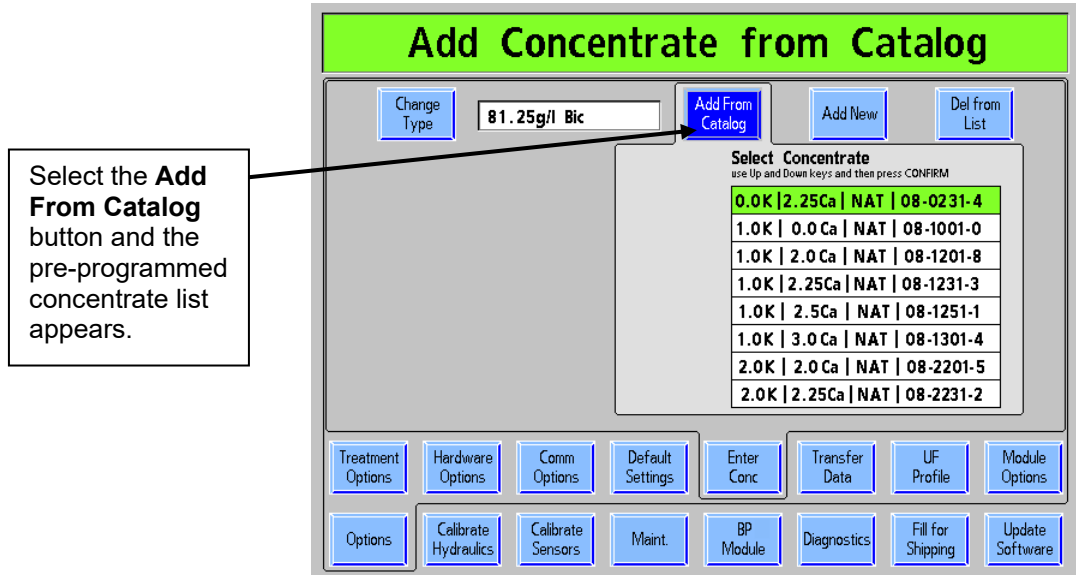

Figure 118 – Adding Acid Concentrates from the Catalog (showing functional software version 2.81 or later)

To add a new concentrate that is not in the catalog

1. Select the **Add New** button and press **CONFIRM** (note: this button is called ‘Add New To List’ in functional software versions 2.72 or later). The “Add New” subscreen will be displayed:

Modify all constituents to match the acid concentrate label

Acid Contribution to Final Dialysate:
1:44 (Nominal Dilution)

SODIUM (Na⁺)	100 mEq/L
POTASSIUM (K⁺)	2.0 mEq/L
CALCIUM (Ca⁺⁺)	2.5 mEq/L
MAGNESIUM (Mg⁺⁺)	1.0 mEq/L
ACETATE	4.0 mEq/L
DEXTROSE	100 mg/dL
CHLORIDE	105.50 mEq/L

Excerpt from NaturaLyte 08-2251-0 Acid Concentrate Label

Figure 119 – Adding a New Acid Concentrate (NaturaLyte 08-2251-0) (showing functional software version 2.81 or later)

2. If the acid concentrate is GranuFlo or Citrasate, select the appropriate toggle-button and press the **CONFIRM** key.
3. Modify all of the constituents to match the ionic contribution of the acid concentrate as listed on its label. The constituents’ selectable parameter-buttons and calculated values change based upon the concentrate type. Specific instructions for entering NaturaLyte, GranuFlo, and Citrasate brand concentrates are provided below. After entering the constituents for the desired acid concentrate, continue with step 4 on page 337.



Note: The acid concentrate labels and values shown are provided as examples. Always refer to the concentrate manufacturer’s “A” concentrate labeling and associated marketing labeling. Contact the concentrate manufacturer with questions regarding composition.

- a. **NaturaLyte** (see Figure 119 above): Enter the values for Sodium (Na⁺), Potassium (K⁺), Calcium (Ca⁺⁺), Magnesium (Mg⁺⁺), Acetic Acid (Acetate), and Dextrose. The calculated values are Chloride (Cl⁻) and Na Acetate.

Modify all constituents to match the acid concentrate label

Acid Contribution to Final Dialysate:
1:44 (Nominal Dilution)

SODIUM (Na⁺)	100	mEq/L
POTASSIUM (K⁺)	2.0	mEq/L
CALCIUM (Ca⁺⁺)	2.5	mEq/L
MAGNESIUM (Mg⁺⁺)	1.0	mEq/L
ACETATE	8.0	mEq/L
DEXTROSE	100	mg/dL
CHLORIDE	101.50	mEq/L

Excerpt from GranuFlo 0F-2251-3B Acid Concentrate Label

Figure 120 – Adding a New Acid Concentrate (GranuFlo 0F-2251-3B) (showing functional software version 2.81 or later)

- b. **GranuFlo** (see Figure 120 above): Enter the values for Sodium (Na⁺), Potassium (K⁺), Calcium (Ca⁺⁺), Magnesium (Mg⁺⁺), Acetic Acid (Acetate), and Dextrose. The calculated values are Chloride (Cl⁻) and Na Acetate.



Note: When entering the Acetate value for GranuFlo concentrates, half of the value is entered as Acetic Acid and the other half is entered as Na Acetate. In the above example, the label shows an Acetate value of 8, so only 4.00 is entered for Acetic Acid.

Modify all constituents to match the acid concentrate label

Acid Contribution to Final Dialysate:
1:44 (Nominal Dilution)

SODIUM (Na⁺)	100.3	mEq/L
POTASSIUM (K⁺)	2.0	mEq/L
CALCIUM (Ca⁺⁺)	2.5	mEq/L
MAGNESIUM (Mg⁺⁺)	1.0	mEq/L
ACETATE	0.3	mEq/L
CITRATE	2.4	mEq/L
DEXTROSE	100	mg/dL
CHLORIDE	105.50	mEq/L

Excerpt from Citrasate 08-2251-CA Acid Concentrate Label

Figure 121 – Adding a New Acid Concentrate (Citrasate 08-2251-CA) (showing functional software version 2.81 or later)

- c. **Citrasate** (see Figure 121 above): Enter the values for Sodium (Na⁺) (first three digits only), Potassium (K⁺), Calcium (Ca⁺⁺), Magnesium (Mg⁺⁺), and Dextrose. The calculated values are Chloride (Cl⁻), Citrate, and Na Acetate.



Note: If the new concentrate is Acetate (when using functional software version 2.69 or earlier), enter the values for the Sodium (Na⁺), Potassium (K⁺), Calcium (Ca⁺⁺), Magnesium (Mg⁺⁺), Acetate, and Dextrose. The calculated values are Chloride (Cl⁻) and Acetic Acid.

4. After all the constituents have been entered, select the **Conc Name** button and then input the desired alphanumeric name using the keyboard. Press **CONFIRM** to save the new concentrate to the available acid concentrate list on the “Enter Conc” screen (see Figure 59).
5. Select the **Enter Conc** screen-button and verify that the new acid concentrate was entered into the available concentrate list.

To add additional concentrates, repeat steps 1-5.



Note: When a citrate-based concentrate is selected in Dialysis/SLED, the dialysate composition list on the “Dialysate” screen will show a meter box for ‘Citrate’.

Dialysate Composition	
TCD	13.7 mS/cm
K ⁺	2.0 mEq/l
Ca ⁺⁺	2.5 mEq/l
Mg ⁺⁺	1.0 mEq/l
Ac.	0.3 mEq/l
Dex.	100 mg/dl
Citrate	2.4 mEq/l
Base Na ⁺	137 mEq/l
Bicarbonate	34 mEq/l

To delete a concentrate from the list of those selected for Dialysis Mode

On the “Enter Conc” screen (see Figure 116), select the **Del From List** button. Use the **↑** / **↓** (up or down) keys located on the keyboard to select the undesired concentrate then press the **CONFIRM** key to delete it.

UF Profile Screen: Creating Custom UF Profiles

In the Dialysis program, the operator has the option of selecting different ultrafiltration (UF) profiles to run the UF pump during treatment. These profiles consist of combinations of higher and lower ultrafiltration rates spread over the course of the remaining treatment time. Four of those UF profiles may be customized using the “UF Profile” Service Mode screen.

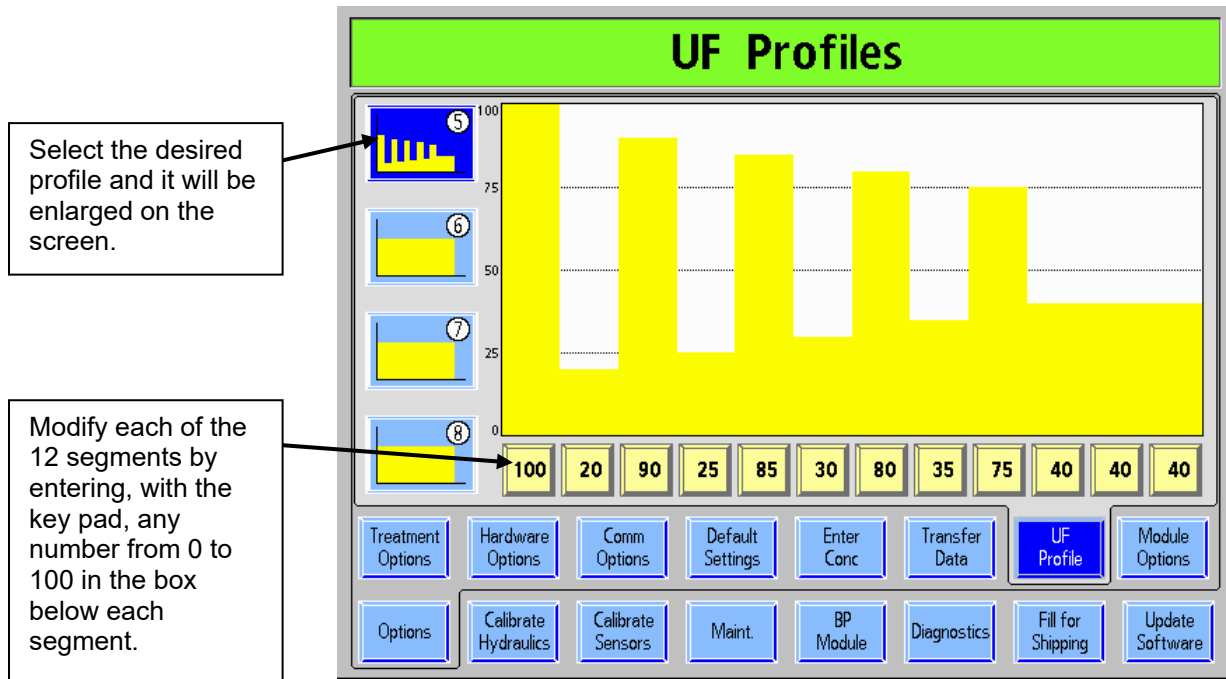

Figure 122 – Creating Custom UF Profiles

To create the four custom UF profiles, do the following:

1. Power the machine on into Service Mode by pressing the **CONFIRM** key when prompted during the power up sequence.
2. Select the **Options** screen-button and then select the **UF Profile** screen-button to view the “UF Profiles” screen. The four UF Profiles that can be modified will be displayed on the left side of the screen numbered from 5 – 8.
3. Select the desired profile to modify and it will then be enlarged with each of the 12 segments displayed in small edit boxes below the profile.
4. One by one, select the yellow numbered button below each of the 12 segments. Enter any number from 0 to 100 using the number keys or using the **↑ / ↓** (up or down) keys located on the keyboard.
5. Press the **CONFIRM** key to save the newly created profile. The newly created profile will be available in the Dialysis program with the number indicated in the upper right corner of the button.

Module Options Screen

The screenshot shows the 'Module Options' screen with a green header. It is divided into three main sections: Misc., Modules, and Alarms. Below these are two rows of navigation buttons.

Misc.	Modules	Alarms
Patient Card: Yes <input type="checkbox"/> No <input checked="" type="checkbox"/>	BTM: Yes <input type="checkbox"/> No <input checked="" type="checkbox"/>	Alarm Type: Acute <input type="checkbox"/> Std. <input checked="" type="checkbox"/>
Crit-Line: Yes <input type="checkbox"/> No <input checked="" type="checkbox"/>	BVM: Yes <input type="checkbox"/> No <input checked="" type="checkbox"/>	Lock Alarm Volume: High
Crit-Line Graph: Hct <input type="checkbox"/> BV <input checked="" type="checkbox"/>	Digital SN Blood Pump: Yes <input type="checkbox"/> No <input checked="" type="checkbox"/>	

Navigation buttons at the bottom:

- Treatment Options
- Hardware Options
- Comm Options
- Default Settings
- Enter Conc
- Transfer Data
- UF Profile
- Module Options (highlighted)
- Options
- Calibrate Hydraulics
- Calibrate Sensors
- Maint.
- BP Module
- Diagnostics
- Fill for Shipping
- Update Software

Figure 123 – Module Options Screen (showing functional software version 2.81 or later and 2008T BlueStar Premium)

PatientCard (functional software version 2.72 or later with 2008T BlueStar Premium)

This button enables or disables the optional PatientCard hardware. See page 38 for more information.

Note: The 'PatientCard' option is part of 2008T BlueStar Premium and requires additional hardware. Contact the Fresenius Medical Care Spare Parts department or your sales representative for more information and pricing.

Crit-Line (functional software version 2.57 or later)

The Crit-Line option must be set to 'Yes' in Service Mode in order to use the Crit-Line in a Clip (CLiC) device during a hemodialysis treatment. **Note:** The BTM and BVM module options are unavailable if Crit-Line is selected.

Crit-Line Graph (functional software version 2.57 or later)

The operator can choose to display either the BV (Blood Volume) or Hct (Hematocrit) graphs on the “Crit-Line” screen. The default Crit-Line graph is the BV graph.

BTM

This button enables or disables the Blood Temperature Module. **Note:** The BTM module option is unavailable if Crit-Line is selected.

BVM

This button enables or disables the Blood Volume Module. **Note:** The BVM module option is unavailable if Crit-Line is selected.

Digital SN Blood Pump

This option is used to enable or disable the use of a digital single needle blood pump option.

Note: If this option is selected while the BTM is set to Yes, the Digital SN Blood Pump and BTM options will be set to ‘No’ and the message “Only one can be set per group” is displayed in the Status Box.

Alarm Type (functional software version 2.72 or later with 2008T BlueStar Premium)

The 2008T hemodialysis machine can be set to ‘Acute’ or ‘Std.’ (default standard) type alarm type. The ‘Acute’ option uses different alarm tones and displays High Alarms with a flashing red Status Light.

Lock Alarm Volume (functional software version 2.72 or later with 2008T BlueStar Premium)

This option is used to lock the alarm volume to either Low, Medium (default), or High, preventing it from being adjusted using the touchscreen in Dialysis Mode. If the ‘Lock Alarm Volume’ option is set to ‘Unlock’, the operator may adjust the alarm volume using the touchscreen in Dialysis Mode (see the Dialogue Box description on page 31 for more information).

Note: The ‘Lock Alarm Volume’ option is part of 2008T BlueStar Premium that requires additional hardware. Contact the Fresenius Medical Care Spare Parts department or your sales representative for more information and pricing.

Scheduler Screen (functional software version 2.72 or later)

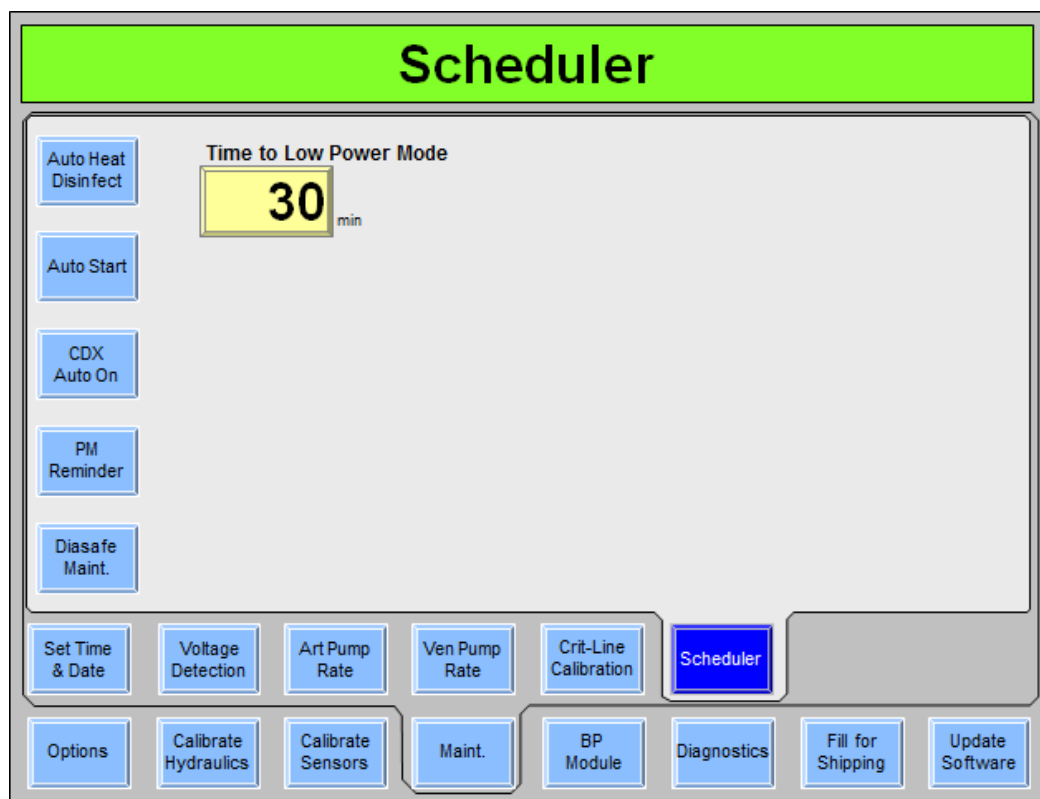

Figure 124 – Service Mode: Scheduler Screen (showing functional software version 2.81 or later and 2008T BlueStar Premium)

Time to Low Power Mode

This option is used to set the time the 2008T hemodialysis machine will remain idle on the “Select Program” screen before entering Low Power Mode. The available selections are: OFF (in which the machine does not enter Low Power Mode), 5, 10, 15, 20, 25, and 30 minutes. In Low Power Mode, the machine’s hydraulics (pumps and valves), modules, and display screen turn off and the hour meter stops incrementing; the Status Light will flash green and the CDX system will remain on. The machine will ‘wake up’ to full power mode when the keyboard, touchscreen, or touchpad are touched.

Note: The ‘Time to Low Power Mode’ option is part of 2008T BlueStar Premium and requires additional hardware. Contact the Fresenius Medical Care Spare Parts department or your sales representative for more information and pricing.

Auto Heat Disinfect (functional software version 2.72 or later with 2008T BlueStar Premium)

This button displays the “Scheduler Auto Heat Disinfect” screen, see page 343 for a description of this feature.

Auto Start (functional software version 2.72 or later with 2008T BlueStar Premium)

This button displays the “Auto Start” screen, see page 345 for a description of this feature.

Note: The ‘Auto Start’ option is part of 2008T BlueStar Premium and requires additional hardware. Contact the Fresenius Medical Care Spare Parts department or your sales representative for more information and pricing.

CDX Auto On (functional software version 2.72 or later with 2008T BlueStar Premium)

This button displays the “CDX Auto On” screen, see page 347 for a description of this feature.

Note: The ‘CDX Auto On’ option is part of 2008T BlueStar Premium and requires additional hardware. Contact the Fresenius Medical Care Spare Parts department or your sales representative for more information and pricing.

PM Reminder (functional software version 2.72 or later with 2008T BlueStar Premium)

This button displays the “Preventive Maintenance Reminder” screen, see page 349 for a description of this feature.

Note: The ‘PM Reminder’ option is part of 2008T BlueStar Premium and requires additional hardware. Contact the Fresenius Medical Care Spare Parts department or your sales representative for more information and pricing.

Diasafe Reminder (functional software version 2.72 or later with 2008T BlueStar Premium)

This button displays the “Diasafe Reminder” screen, see page 352 for a description of this feature.

Note: The ‘Diasafe Reminder’ option is part of 2008T BlueStar Premium and requires additional hardware. Contact the Fresenius Medical Care Spare Parts department or your sales representative for more information and pricing.

Auto Heat Disinfection (functional software version 2.72 or later)

The Auto Heat Disinfection option is a special feature* that allows the user to program the 2008T hemodialysis machine to automatically run a heat disinfection program according to a schedule. In the “Maint.: Scheduler: Auto Heat Disinfection” screen the user may select a unique start time for any day(s) of the week.

This program affects only the start time of the Heat Disinfection, all other settings function as usual. With the machine on and set up for rinse, the Heat Disinfection program will run at the selected time(s).



Note: If another rinse is running when the Auto Heat Disinfection is set to run, the Auto Heat Disinfection will start after the first rinse ends.

Setting Auto Heat Disinfection Times

1. Go to Service Mode and select the “Maint.: Scheduler: Auto Heat Disinfection screen (see below).

Figure 125 – Scheduler Auto Heat Disinfection Screen (showing functional software version 2.81 or later)

*The Auto Heat Disinfection feature is included in the 2008T BlueStar premium features or is available with kit P/N 190679. If you are using an RO system for heat disinfection, you will need the high temperature inlet and drain tubing included in kit P/N 190679. This kit is not included with 2008T BlueStar premium but must be purchased separately. Contact the

Fresenius Medical Care Spare Parts department or your sales representative for more information and pricing.

2. Select the desired day(s) of the week to automatically run the Heat Disinfection program, and using the keyboard, enter the time at which the Heat Disinfection should automatically begin. Scrolling above 23:59 to OFF will indicate the Auto Heat Disinfection does not run on that selected day.



Note: The clock is a 24 hour clock, so 0:00 is midnight and 13:00 is 1:00 PM.

3. Select Pre-Rinse Time button and enter the desired time for a rinse that runs before the Auto Heat Disinfection program. The heater will be off during the pre-rinse.
4. To automatically turn off the machine after a Heat Disinfection program ends, select the Off after Heat Disin toggle-button to set it to 'Yes'.



Note: Setting the 'Off after Heat Disin' option to 'Yes' will cause the machine to automatically turn off after every heat disinfection program, including those manually selected.

5. Press the **CONFIRM** key to confirm the changes, then power down the machine for two minutes.



Note: If the 2008T hemodialysis machine is equipped with 2008T BlueStar Premium, the machine does not need to be left running: programming the Auto Heat Disinfection will cause the machine to automatically turn on at the desired time to run the Heat Disinfection program. Instead, the machine may be turned off beforehand using the **Power** key on the Control Panel (unless the 'CDX Auto On' feature is set for the day, see page 347 for more information).

6. Power on the machine and go to the "Select Program" screen.
7. Ensure that both dialysate lines are on the shunt.
8. Place both concentrate connectors in their respective ports. The Auto Heat Disinfection program will automatically run at the selected time(s) when the dialysate lines are on the shunt and both concentrate connectors are in their respective ports.



Note: If the Service Mode option 'Off after heat disin' is set to 'Yes', the machine will automatically turn off after the Heat Disinfection program is complete (unless the 'CDX Auto On' feature is set for the day, see page 347 for more information).

Auto Start (functional software version 2.74 or later)

The Auto Start option is part of 2008T BlueStar Premium* and it allows the user to program the 2008T hemodialysis machine to automatically start up according to a schedule and begin testing when concentrates are connected. In the “Maint.: Scheduler: Auto Start Action Process” screen the user may select a unique start time for any day(s) of the week. There is also an option of scheduling an Auto Start Rinse program with Auto Start (functional software version 2.74 or later).

This program affects the start time and testing sequence of the 2008T hemodialysis machine for treatment setup, all other settings function as usual. With the concentrates are connected, the Auto Start program will run at the selected time(s). If an Auto Start Rinse is programmed, the Auto Start, including the Auto Start Rinse, will begin at the selected time(s).



Note: It is recommended that any Auto Heat Disinfectoin programs finish with enough time to cool down before the 2008T hemodialysis machine automatically powers on for treatment using the Auto Start feature.

Setting Auto Start and Auto Start Rinse Times

1. Go to Service Mode and select the “Maint.: Scheduler: Auto Start” screen (see below).

The screenshot shows the 'Auto Start' configuration screen. At the top, a green header displays 'Auto Start'. Below it, a grey box contains the instruction: 'Select the time for each day of the week to automatically power on the machine (24-hour format)'. The screen is organized into a grid for each day of the week:

Day	Time (h:min)	Auto Rinse	Yes	No
Monday	06:00	<input type="checkbox"/>	<input checked="" type="checkbox"/>	
Tuesday	07:00	<input type="checkbox"/>	<input checked="" type="checkbox"/>	
Wednesday	07:00	<input type="checkbox"/>	<input checked="" type="checkbox"/>	
Thursday	06:00	<input type="checkbox"/>	<input checked="" type="checkbox"/>	
Friday	06:00	<input type="checkbox"/>	<input checked="" type="checkbox"/>	
Saturday	10:00	<input type="checkbox"/>	<input checked="" type="checkbox"/>	
Sunday	OFF	<input type="checkbox"/>	<input checked="" type="checkbox"/>	

On the left side of the screen, there is a vertical menu with buttons for: Auto Heat Disinfect, Auto Start (highlighted), CDX Auto On, PM Reminder, and Diasafe Maint. At the bottom, there are two rows of navigation buttons: Set Time & Date, Voltage Detection, Art Pump Rate, Ven Pump Rate, Crit-Line Calibration, Scheduler, Options, Calibrate Hydraulics, Calibrate Sensors, Maint., BP Module, Diagnostics, Fill for Shipping, and Update Software.

Figure 126 – Auto Start screen (showing functional software version 2.81 or later)

*The Auto Start feature is available with 2008T BlueStar Premium. Contact the Fresenius Medical Care Spare Parts department or your sales representative for more information and pricing.

2. Select the desired day(s) of the week and enter the time at which the Auto Start program should automatically begin. Scrolling above 23:59 to OFF will indicate the Auto Start program does not run on that selected day.



Note: The clock is a 24 hour clock, so 0:00 is midnight and 13:00 is 1:00 PM.

3. Select the days of the week on which an Auto Start Rinse program will be part of the Auto Start program. Click on the 'Yes' box next to the desired days.



Note: If the Auto Start Rinse program is interrupted (by removing a concentrate connector or opening the bibag door) the Auto Start Rinse and the Auto Start program for that day will be cancelled. If a rinse is desired before treatment, it must be programmed manually.

4. Press the **CONFIRM** key to confirm the changes then power down the machine for two minutes.
5. Ensure that both dialysate lines are on the shunt. Inserting the concentrate connectors in their rinse ports allows other programs to run like Auto Heat Disinfection; however, the concentrates must be connected to the appropriate acid and bicarbonate sources for the Auto Start program to automatically enter the Dialysis program and begin testing. For more information about using the Auto Start feature, see page 57.



Note: If the 'CDX Auto On' feature is also set for the same day; the machine will automatically power on at midnight (0:00). The machine will go into Low Power Mode after the delay you have set in Service Mode (if any) using the Low Power button in the "Maint." screen. If the Low Power Mode delay option is off, the machine will operate at full power at power-up. See page 347 for more information about CDX Auto On.

CDX Auto On (functional software version 2.72 or later)

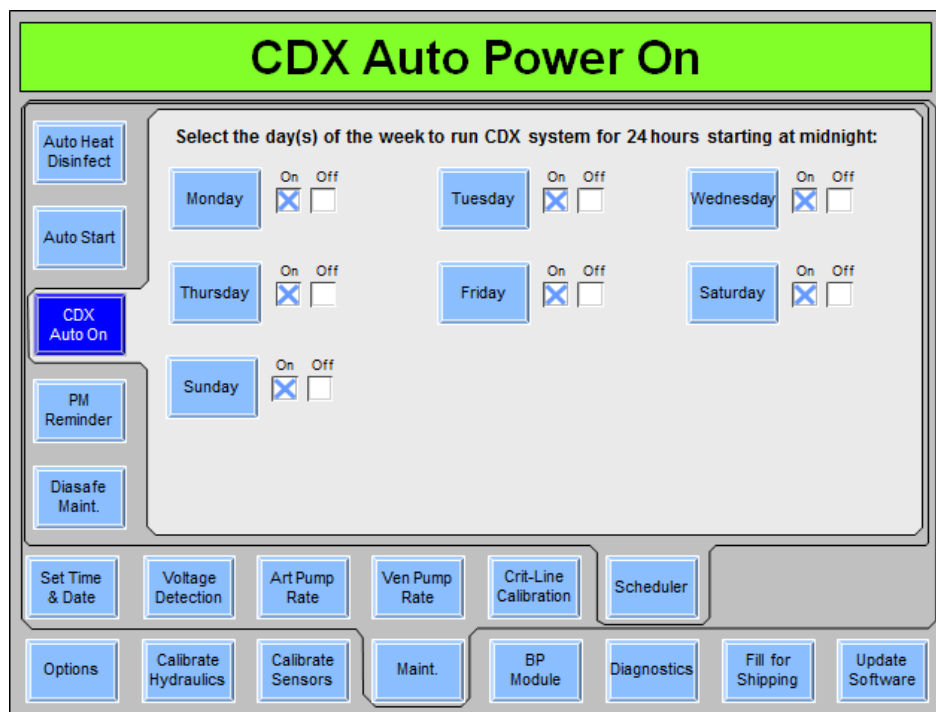

Figure 127 – Scheduler CDX Auto Power On Screen (showing functional software version 2.81 or later)

The CDX Auto On option is part of 2008T BlueStar Premium* and it allows the user to program the 2008T hemodialysis machine’s CDX system to automatically power on (see page 341) and stay on for the following 24 hour period. In the “Maint.: Scheduler: CDX Auto On” screen the user may select the day(s) of the week for the CDX system to remain on for a period of 24 hours starting from midnight (0:00). This is useful for scheduling information systems maintenance and data transfers.

To set a day of the week for the CDX system to be on for 24 hours starting at 0:00 a.m. (midnight), select the desired toggle-button to toggle it to ‘On’ and then press the **CONFIRM** key to save the change. After selecting the desired day(s) of the week, power down the machine for two minutes and then power it back on to complete the process.

This program affects only the CDX system, all other settings function as usual.



Note: If the 2008T hemodialysis machine is set to be on for the entire day, the only way to turn off the machine is to set the Mains Power switch on the back of the machine to OFF (see Figure 10 on page 36). If the **Power** key is used to turn off the 2008T hemodialysis machine, the machine will turn itself back on after two minutes and then enter Low Power Mode according to the time set on the “Scheduler” screen, see page 341. This is to prevent interruptions to CDX system access.

*The CDX Auto On feature is only available with 2008T BlueStar Premium. Contact the Fresenius Medical Care Spare Parts department or your sales representative for more information and pricing.

Auto On Features: General Considerations

The following observations should be considered when using the Auto On features:



Note: The Auto On features include Auto Start (Auto Rinse), CDX Auto On and Auto Heat Disinfect.

- The machine can automatically power on with the CDX Auto On feature only on the days selected in Service Mode. This occurs at midnight (00:00).
- Once the programmed start begins, the Auto Start and Auto Heat Disinfect features require a fifteen-minute window with no conflicting activity. No other activities should be scheduled during this time.
- At the start of the day, if CDX Auto On is not enabled, the user must power on the machine manually, or program the Auto Start feature by selecting a date and time in Service Mode. For Auto Start (with or without Auto Rinse) to begin as programmed, the machine must be powered off and then back on in order for the scheduler to update.



Note: The CDX Auto On and Auto Start programs are not interchangeable. Auto Start runs the self tests, whereas CDX Auto On does not.

- Auto Start (with or without Auto Rinse) may be programmed to run on any day, regardless of whether CDX Auto On is in use. Auto Start (with or without Auto Rinse) is independent of CDX Auto On.
- Auto Rinse defaults to No in Service Mode. To use this feature, the customer must enter Service Mode and select the days and times for it to run. If a customer does not want Auto Rinse to engage (especially when staff are not present), the selection for this feature must remain 'No' in Service Mode.
- To prevent unintended event overlap, the scheduled times a clinic performs RO system and water loop maintenance events should be considered when programming Auto On feature times.

PM Reminder

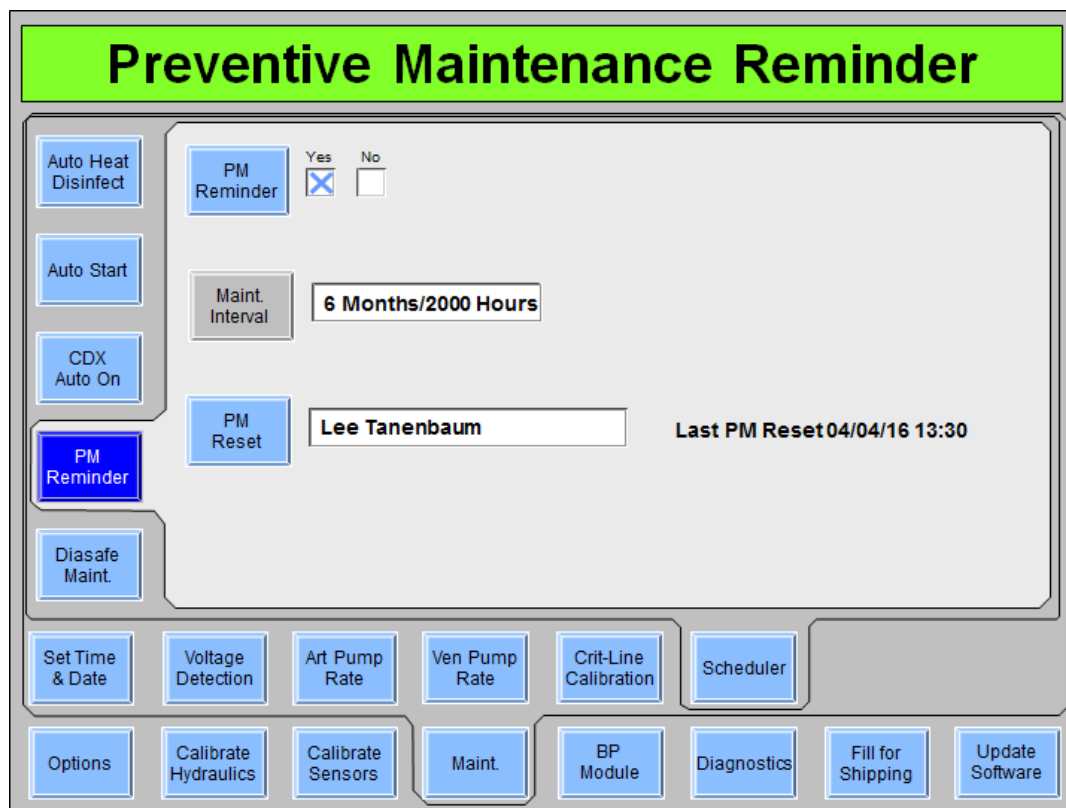

Figure 128 – Scheduler PM Reminder Screen (showing functional software version 2.81 or later)

The PM (Preventive Maintenance) Reminder option is part of 2008T BlueStar Premium * and it allows the user to program the 2008T hemodialysis machine to display the next preventive maintenance due date on the “Select Program” screen (see Figure 129). The Service Mode “PM Reminder” screen also records the name of the technician that performed the last PM reminder reset (see above). If the PM Reminder is set to ‘No’, this name must be removed and the box left blank or the PM Reminder will continue to be displayed.

To set the next PM Reminder after the preventive maintenance has been performed:

1. Go to Service Mode and select the “Maint.: Scheduler: PM Reminder” screen (see above).
2. Select the **PM Reminder** toggle-button to set it from ‘No’ to ‘Yes’ then press the **CONFIRM** key.



Note: The six month interval is based on the date set on the Service Mode “Maint.: Set Time & Date” screen. The hours are based on the machine’s digital hour meter set on the Service Mode “Update Software: S/N & Hour Meter” screen and displayed on the “Select Program” screen.

*The PM Reminder feature is only available with special hardware. Contact the Fresenius Medical Care Spare Parts department or your sales representative for more information and pricing.

3. Select the **PM Reset** button and, using the keyboard, enter the technician’s name setting the PM reminder then press the **CONFIRM** key. This will reset the six month countdown clock from the last PM date and save the technician’s name and date the PM interval was reset (see Figure 128). This overwrites the name and date of the technician who performed the previous PM reset.
4. Perform a long power down for the changes to take effect.

Once set, the PM Reminder will display the next PM due date on the “Select Program” screen (see below). This date is calculated based on the set interval from the last reset date.

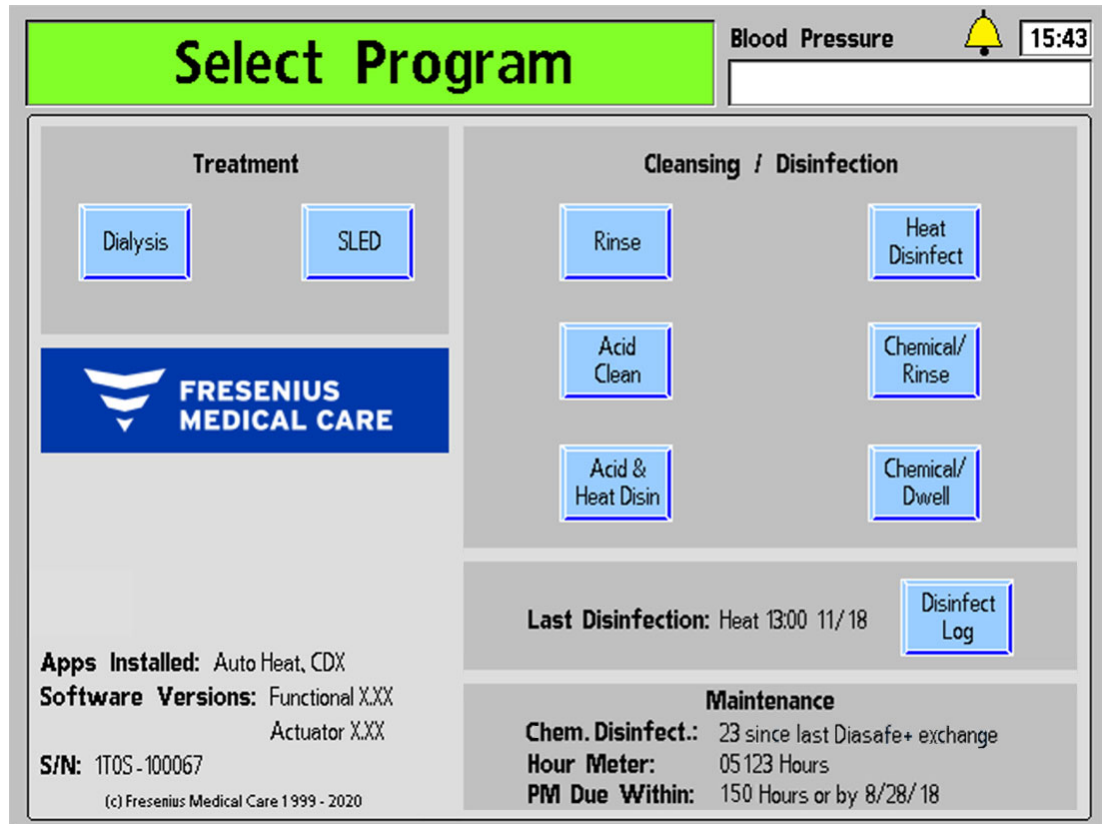

Figure 129 – PM Reminder displayed on the Select Program Screen (showing functional software version 2.81 or later)



Note: The PM Reminder hours are based on the Hour Meter displayed on the “Select Program” screen and not the external hour meter on the back of the machine (if present).

When the next PM due is within 14 days and/or 150 hours, whichever comes first, an additional message will appear on the “Select Program” screen to remind the operator that the preventive maintenance due date is approaching, see Figure 130 on the next page. The remaining hours will continue to count down to zero days and the additional reminder message will remain until the PM Reminder is reset again.



Note: The hours indicated in the Preventive Maintenance Reminder apply only to the Annual/4,000 hour and 24 Month/8,000 hour Preventive Maintenance.

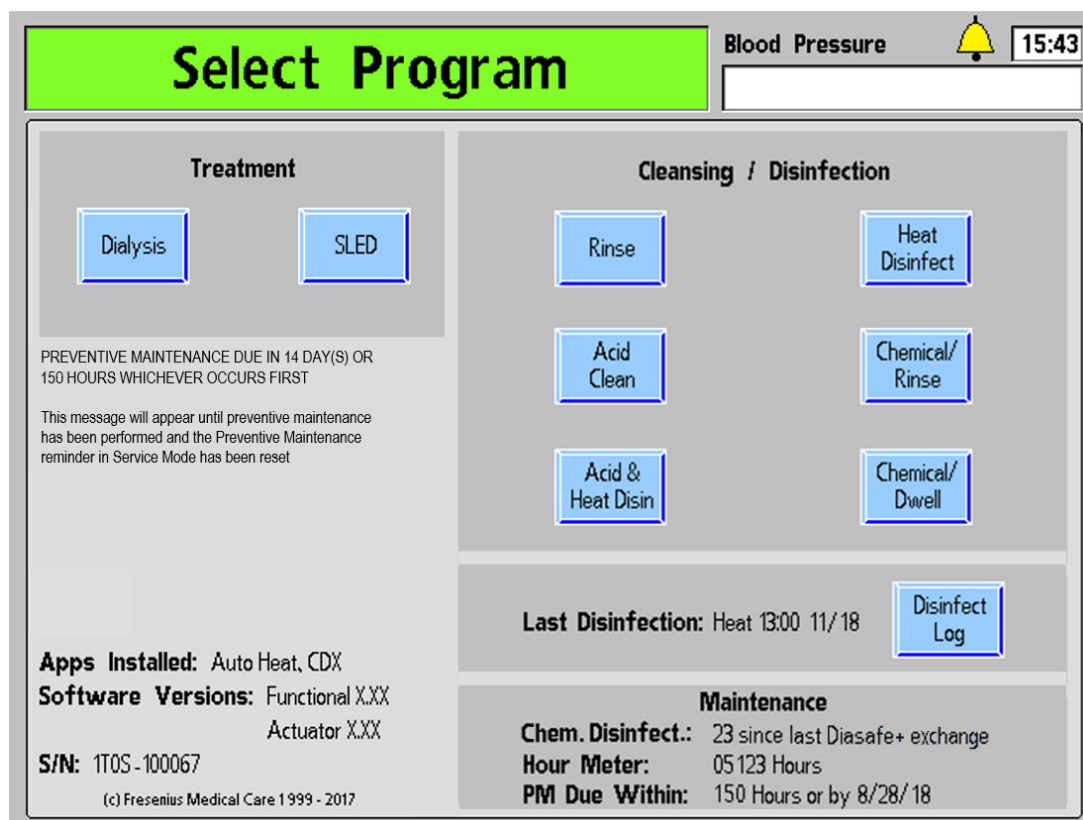

Figure 130 – Additional PM Reminder displayed on the Select Program Screen (showing functional software version 2.81 or later)



Note: If a Diasafe Reminder also occurs during this time, it will be displayed above the additional PM Reminder message, see page 352 for more information.

Diasafe Reminder

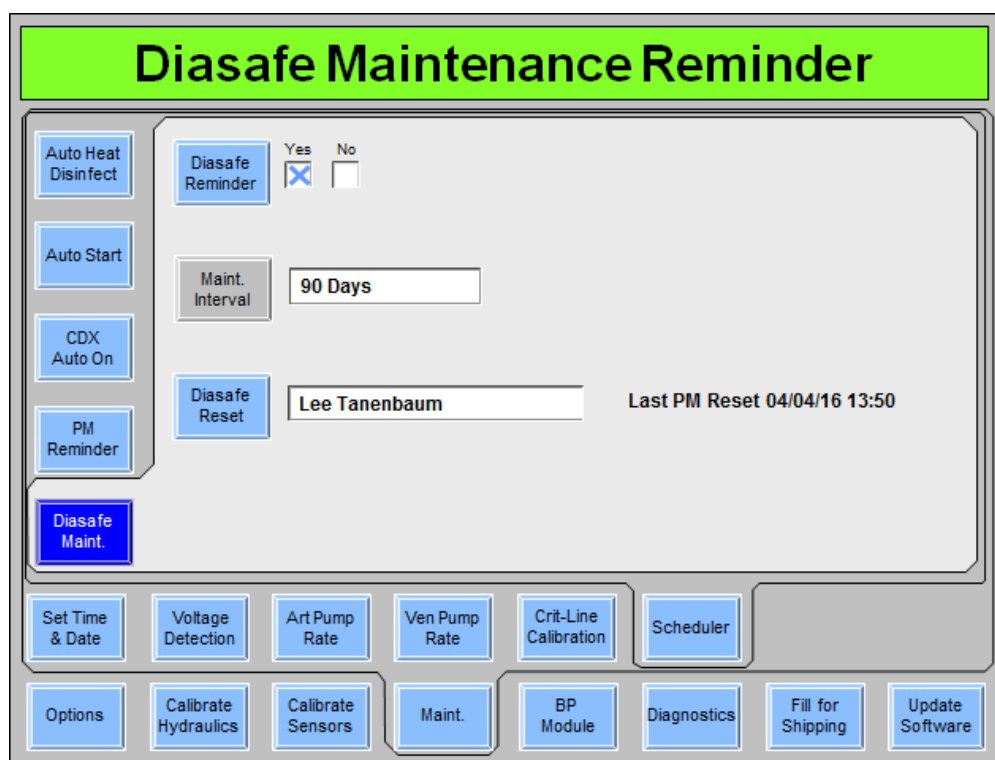

Figure 131 – Scheduler Diasafe Maint. Screen (showing functional software version 2.81 or later)

The Diasafe Reminder option is part of 2008T BlueStar Premium * and it allows the user to program the 2008T hemodialysis machine to display a reminder on the “Select Program” screen (see Figure 132) to replace the DIASAFE *plus*_{US} filter starting seven days before the 90 day period has expired. The Service Mode “Diasafe Maintenance Reminder” screen also records the name of the technician that performed the last Diasafe reminder reset.

To set the next Diasafe Reminder after the filter has been replaced:

1. Go to Service Mode and select the “Maint.: Scheduler: Diasafe Maint.” screen (see above).
2. Select the **Diasafe Reminder** toggle-button to set it from ‘No’ to ‘Yes’ then press the **CONFIRM** key.



Note: The DIASAFE *plus*_{US} filter must be replaced every 90 days. After being reset, the days start counting down from 90 days based on the date set on the Service Mode “Maint.: Set Time & Date” screen.

*The Diasafe Reminder feature is only available with 2008T BlueStar Premium. Contact the Fresenius Medical Care Spare Parts department or your sales representative for more information and pricing.

3. Select the **Diasafe Reset** button and, using the keyboard, enter the technician's name setting the PM reminder then press the **CONFIRM** key (for software version 2.81 or later, the name will populate the box automatically). This will reset the countdown clock from the last DIASAFE *plus*_{US} filter replacement date and save the technician's name and date the 90 day timer was reset (see Figure 131). This overwrites the name and date of the technician who performed the previous PM reset.
4. Perform a long power down for the changes to take effect.

When the next DIASAFE *plus*_{US} filter replacement is due within 7 days, a message will appear on the "Select Program" screen to remind the operator that the DIASAFE *plus*_{US} filter maintenance due date is approaching, see Figure 132 below. The remaining hours will continue to count down to zero days and the reminder message will remain until the Diasafe Reminder is reset again.

Chemical Disinfection Counter:

In functional software version 2.81 or later, the user can program the "Select Program" screen so that it will display the number of chemical disinfections performed since the last Diasafe Plus filter replacement, so long as the Diasafe Reminder has been reset as described above. On the "Diasafe Maintenance Reminder" screen (see Figure 131) toggle the **Chemical Counter** button to Yes. The "Chem. Disinfect" counter will appear on the "Select Program" screen in the bottom right corner under the heading "Maintenance" (see Figure 132 below).

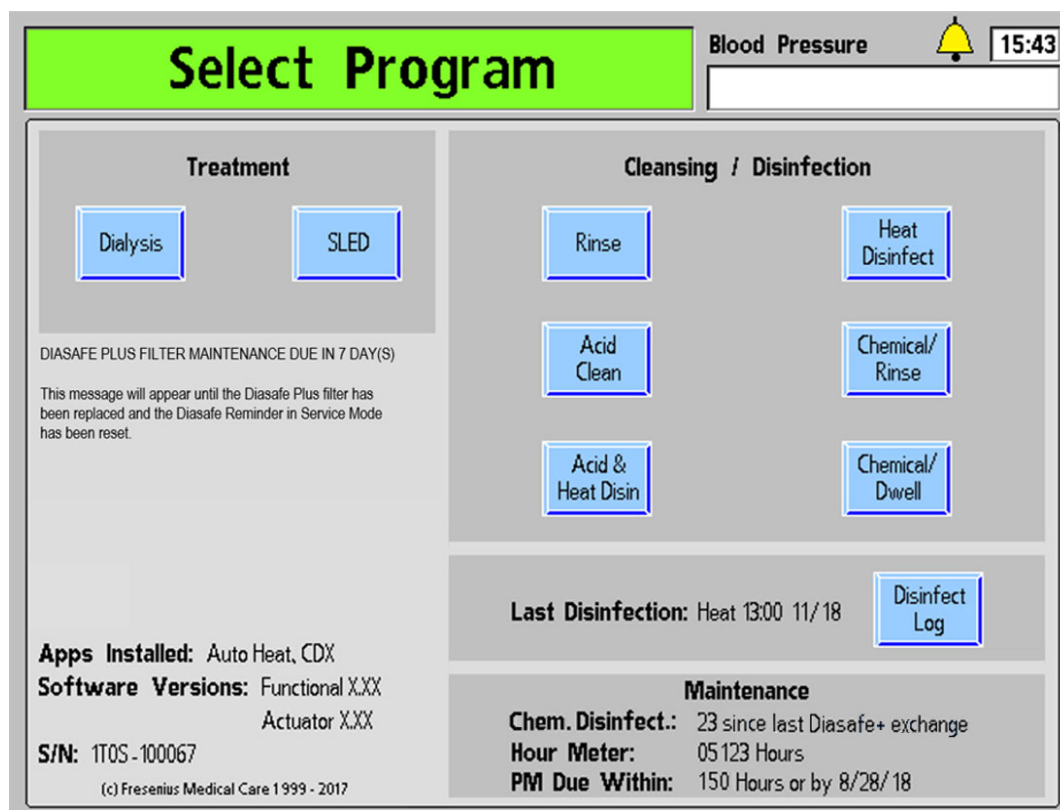

Figure 132 – Diasafe Reminder message displayed on the Select Program Screen (showing functional software version 2.81 or later)



Note: If the additional PM Reminder message also occurs during this time, it will be displayed below the Diasafe Reminder message, see page 349 for more information.

Cybersecurity

For the protection of users and patients, the 2008T hemodialysis machine (functional board software version 2.81 and later) requires an administrator to institute a system of password protection for user access to Service Mode. Dialysis Mode remains unaffected by this system.



Note: For more information on cybersecurity, please consult the 2008T BlueStar (P/N 490437).

Manage User

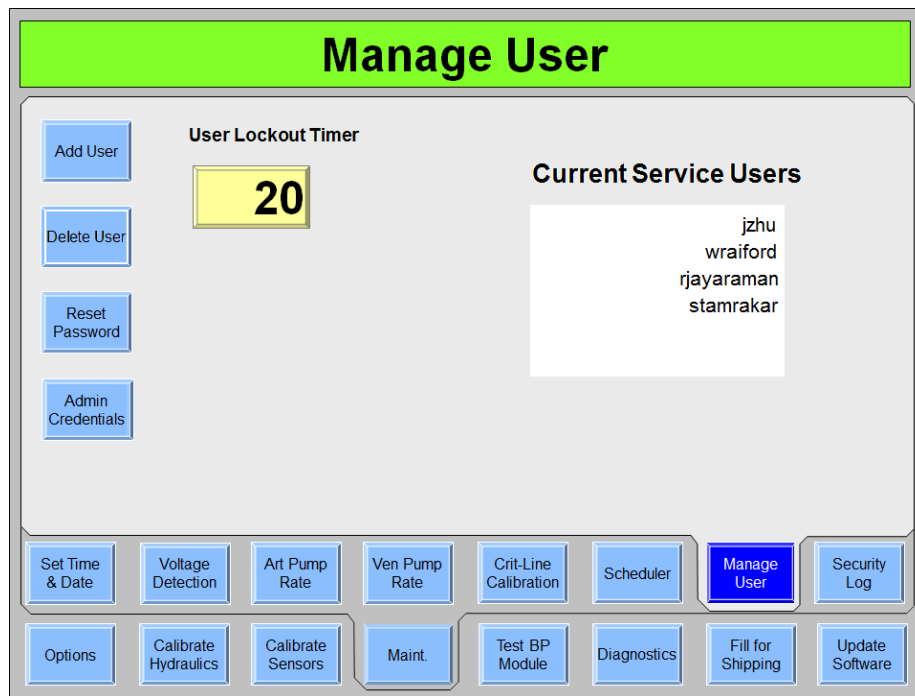
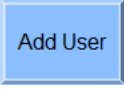
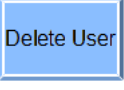
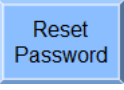
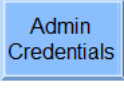



Figure 133 – The “Manage User” screen (functional software version 2.81 or later)

Users with administrative privileges may use the buttons on this screen to authorize or remove permission to use Service Mode (see Table 43 below).

Table 43 – Buttons on the “Manage User” screen

Button	Description
	Use this button to authorize a service user. The user name must have at least 3 and no more than 16 alphanumeric characters. The first character must be a letter. Up to 5 users can be added.
	Use this button to remove someone from the list of authorized service users.
	Use this button to reset the password of a service user who needs a new password. This will be a temporary password that the service user will be asked to change upon first login.
	Use this button to change the administrator’s user name or password.
<p data-bbox="337 821 573 846">Inactivity Logout Timer</p> 	Use this button to set the time that the screen will remain active without being touched. The choices for this setting are 5, 10, 15 or 20 minutes. When the set time has elapsed, the user will be logged out.



Note: If a user does not have administrative privileges, the Manage User button will be disabled (greyed out).

Security Log

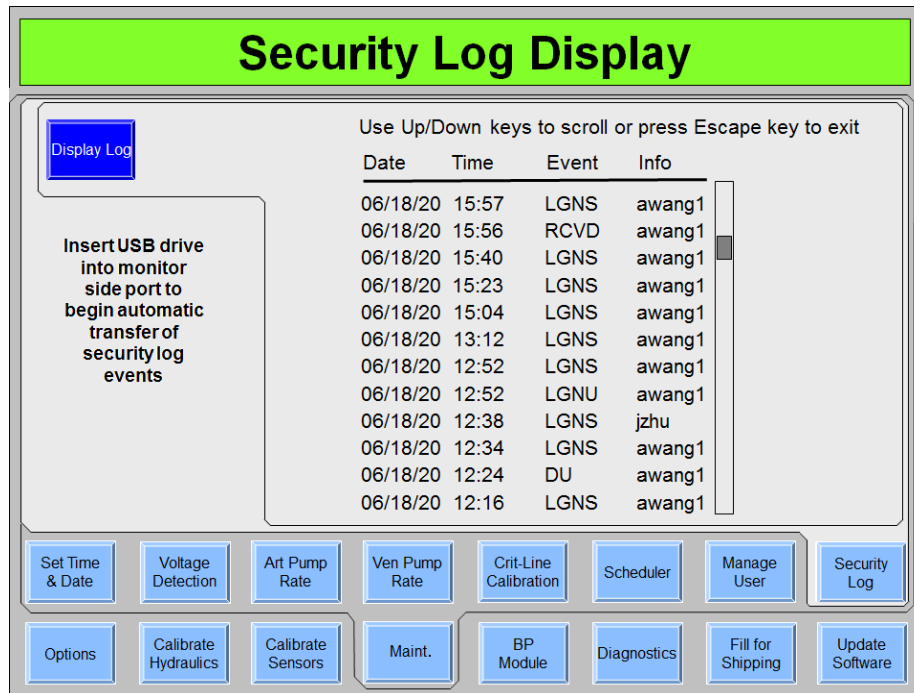

Figure 134 – The “Security Log” screen (functional software version 2.81 or later)

Security events are recorded in a security log that can be viewed on this screen. Security events include software updates, adding and deleting users, password changes and administrator credential changes. Up to 450 events can be recorded in the log. The meaning of the codes used on this screen is as follows:

SWFC: Complete Functional Board Software Upgrade
SWAC: Complete Actuator Test Board Software Upgrade
SWUC: Complete UIMICS Board Software Upgrade
SWFF: Failed Functional Board Software Upgrade
SWAF: Failed Actuator Test Board Software Upgrade

SWUF: Failed UIMICS Board Software Upgrade
LGNS: Successful Login
LGNU: Unsuccessful login
RVCD: Recovery Code request
AU: Add user
DU: Delete User
RP: Reset Password
AC: Admin Credential Change



Note: The USB drive used to save the security log must be less than 4GB and formatted to the FAT32 file system.

BP Defaults

BP Defaults

These default settings do not apply to Low Volume Dialysis Patients.
For SLED patients, Interval (Clock Time) Default is OFF

Blood Pressure Alarm Limits	
Upper Sys	Lower Sys
150 mmHg	60 mmHg
Upper Dia	Lower Dia
200 mmHg	40 mmHg
Upper Pulse	Lower Pulse
150 /min	40 /min
Interval	
Blood Pressure Setting:	0:15 h:min

Navigation buttons: Inflation Speed, Deflation Speed, Air Leakage, Calibrate Mode, BP Defaults, Options, Calibrate Hydraulics, Calibrate Sensors, Maint., BP Module, Diagnostics, Fill for Shipping, Update Software.

Figure 135 – BP Defaults Screen (showing functional software version 2.81 or later)

On this screen the user can program, within limits, blood pressure alarm limit values that will not revert to machine defaults when the **New Tx** key is pressed. The values entered and confirmed here will remain the default values until changed by an authorized service technician.



Note: BP Defaults settings entered here will not be applied to Low Volume Dialysis patients.

Other Options

There are other options on these screens that may not be specifically described here. Generally, these are setup options that are based upon the presence or absence of other modules or hardware.

Options which require a “key” for activation

Certain options are extra cost or limited in availability and must be activated by use of a special code stored on the 2008T hemodialysis machine. Examples of this sort of feature include 2008T BlueStar Premium, CDX and SLED. Upon purchase of such a feature, follow the installation procedure included with the key to activate it on the machine. Contact Fresenius Medical Care Spare Parts department or your sales representative for more information and pricing.

Testing the Dialysate

The operator should test the dialysate for proper conductivity and pH before each dialysis treatment. The operator should also test for residual disinfectant before each dialysis treatment when using a reuse dialyzer.

The Dialysate Sample Port is special connector on the dialyzer supply line. Opening the connection allows the operator to conveniently draw a dialysate sample from the 2008T hemodialysis machine's dialysate flow path. This sample may then be used to test the dialysate for conductivity, pH, and residual disinfectant.

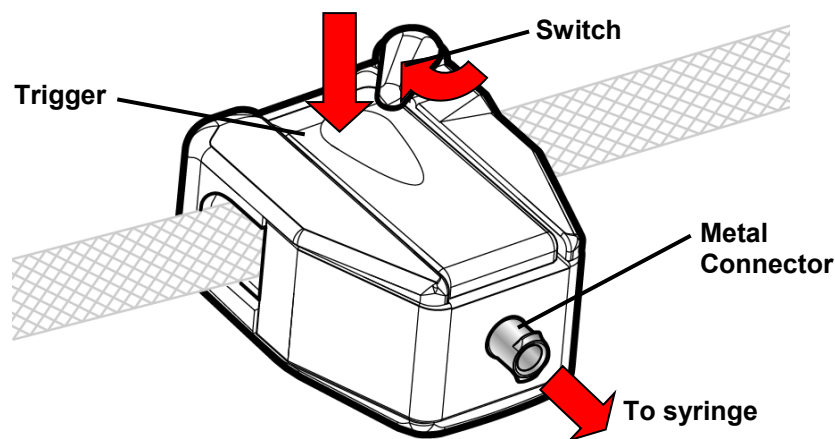

Figure 136 – Dialysate Sampling from the Dialysate Sample Port (Port Open)

To draw a dialysate sample from the Dialysate Sample Port

1. Verify the following:
 - The dialysate lines are on the shunt
 - The machine's conductivity and temperature readings have stabilized
 - The external independent conductivity meter has been properly calibrated



Warning! Wear appropriate personal protection equipment (PPE) when obtaining dialysate samples from the dialysate port.

2. With the plunger pushed all the way in, connect a 10 cc syringe to the metal connector on the dialysate sample port.
3. Press down on the dialysate sampler port trigger and flip the switch to lock the port in the open position (see Figure 136). The dialysate path will now be open through the dialysate sample port to the syringe.
4. Pull back on the syringe plunger to draw the dialysate into the syringe.

5. Close the dialysate sample port: Flip the switch away from the trigger and release the trigger (see “The Shunt Interlock” on page 48 for a picture of dialysate sample port with the switch pushed away from the trigger). The dialysate sample port is now closed again.
6. Disconnect the syringe from the dialysate sample port and discard first sample.
7. Reconnect the syringe to the dialysate sample port, open the dialysate sample port and collect the required amount of dialysate for testing per clinic protocol.



Warning! When connecting a syringe directly to the dialysate sample port, do not inject used dialysate back into the system.



Note: If the testing sample is measured in a container, be sure to rinse the container with dialysate at least three times in order to bring the container up to the temperature of dialysate for proper conductivity.

8. Close the dialysate sample port and disconnect the syringe. Use the facility’s standard measuring devices and follow the device’s instructions to test the dialysate sample per clinic protocol for:
 - Conductivity - for example, set the meter to read conductivity, connect the syringe, and observe the readings. If the reading is not reasonably close to the theoretical conductivity value (TCD), check the meter’s calibration and retest the dialysate sample. If the reading is still not within limits, take the 2008T hemodialysis machine out of service and contact a qualified technician.
 - pH - for example, using pH paper, dip the indicator strip in the dialysate for one (1) second and immediately compare it to the manufacturer’s color chart. The color on the indicator strip will indicate the dialysate’s pH. If the reading is not between 6.9 and 7.6, test with another pH indicator strip. If the reading is still not within the specified limits, take the 2008T hemodialysis machine out of service and contact a qualified technician.
 - Residual disinfectant - see “Testing for Disinfectant” on page 196 for more information



Warning! After testing the dialysate through independent means (e.g., using a conductivity meter and pH paper or meter), verify that the conductivity is reasonably close to the theoretical conductivity value (TCD) and the pH is between 6.9 and 7.6. The machine must also be free of residual disinfectant. If these conditions are not met, do not initiate dialysis.

9. Document the conductivity, pH, or residual disinfectant test readings in the patient treatment record or flow sheet.



Note: Make sure the dialysate sample port switch is locked away from the trigger and the trigger is not pressed down after taking a dialysate sample. Allowing the trigger to stay depressed will cause fluid leaks.

Equipment Storage and Maintenance

Follow the storage and maintenance procedures below for dialysis equipment used for Intermittent Hemodialysis (IHD) in the ICU setting and when decommissioning any dialysis equipment.



Warning! Possible explosion hazard if used in the presence of flammable anesthetics.

Storage Location

If the dialysis unit is incorporated in the hospital, the equipment should be stored so that it will not be damaged. The maintenance of the equipment is normally part of the duty of the dialysis service technician. Depending on the disinfectant and the storage time, frequent flushing of the equipment is necessary.

If it is more convenient to store the equipment close to the ICU, the dedicated storage space should have an access to tap water, power and a drain. The room should have a temperature above 5 °C. If disinfectant is used, the room should be well vented.

Storage Preparation

Before storing the 2008T hemodialysis machine, the hydraulics should be disinfected. It is also necessary to wipe the external parts of the machine with a surface cleaner. Frequency of disinfection and length of the dwell time depend on the disinfectant and shall be determined by acceptable culture result. The following table lists commonly used procedures to store equipment and then return it from storage. Validate your own procedure according to the hospital policy. After prolonged storage, use a bleach disinfectant prior to patient use.

Table 44 – Disinfectant Information

Disinfectant	Program	Dwell time	Retest and Repeat
Formaldehyde	Fill for Shipping* (Service Mode) OR Chemical/ Dwell Program**	Unlimited	3 – 4 weeks
Bleach	Chemical Disinfection program	<u>Only</u> for time of disinfection program	24 hours
Renalin 100	Chemical Disinfection program	<u>Only</u> for time of disinfection program	24 hours
Heat	Heat Disinfection program	Recirculate and shut machine off	24 hours

* For Fill for Shipping program solution details, refer to page 362.

** A 37% formaldehyde solution (commercially available) is required for the Chemical/Dwell program. The Chemical/Dwell program will automatically proportion the 37% formaldehyde solution to deliver a ~1% formaldehyde solution to the machine's hydraulics. Unlike the Fill for Shipping program, the Chemical/Dwell program will not fill the water inlet line with formaldehyde solution.

Machine Specifications

Dimensions

Floor space	Approximately 54 cm wide by 63 cm deep
Height	149 cm
Total weight	Approximately 90 kg
Operating conditions	60 – 100 °F (15.5 – 38 °C) Relative Humidity 10% to 90%, non-condensing
Transport and Storage conditions	18 months Temperature: without antifreeze: +5 to +60 °C (41 to 140 °F) with antifreeze*: -20 to +60 °C (-20 to 140 °F) Relative Humidity 10% to 90%, non-condensing *Antifreeze solution is 50.00% glycerin, 49.25% water, and 0.75% formaldehyde by volume

Electrical

Power Supply—Main	Single phase AC 117 V \pm 10% 60 Hz \pm 3 Hz must be connected to a circuit which is equipped with a hospital grade receptacle and is protected by circuit breaker and ground fault interrupter (GFI). Resistance from chassis to ground must be < 0.2 ohm.
Power Consumption	Does not exceed 12.6 amps @ 117VAC
Energy Consumption	2.2 kwh, typical* *typical dialysis treatment conditions: inlet water temp 23 °C (73.4 °F), target
Energy Delivered to Environment	0.9 kwh, typical* dialysate temp 37°C (98.6 °F), dialysate flow rate 500 ml/min,
Energy Delivered to Drain	1.3 kwh, typical* treatment time 4 hours
Dialysate Heater	1.3 kW rating, electronically controlled
Fuses	Mains Fuses, SI2 and SI6: 6.3 A, 250V, time lag (slow blow fuse), 5x20mm Breaking Capacity 1500A at 250VAC Heater circuit breaker: 16 amp double pole rocker switch
External Connections	Isolated RS232 and Ethernet ports; leakage current isolation per UL 60601-1 between the machine and external computer.
Electromagnetic compatibility	See EMC Declaration on page 373

Electrical safety (UL 60601-1)

Isolation from supply mains	POWER switch on power supply rear panel: O position
Protection against electric shock	Type: Safety class I Degree: Type B Defibrillation-proof Type CF: Only BPM Blood Pressure Cuff (P/N F40016607-F40016611)
Leakage currents	According to UL 60601-1 Limit: 10 μ A, normal condition; 50 μ A, single fault condition

Water

Ingress Rating	IPX1 (Vertical drip-proof protection)
Back Flow Prevention	Integral back flow prevention provided by external vent to atmosphere in water inlet circuit.
Water Pressure	Min 20 psi; max 105 psi
Water Temperature	Min 50 °F (10 °C); max 77 °F (25 °C)
Water Quality	Current national (U.S.) Standards for the Quality of Water: <ul style="list-style-type: none"> • ANSI/AAMI 13959:2014, Water for hemodialysis and related therapies • ANSI/AAMI 26722:2014, Water treatment equipment for hemodialysis applications and related therapies Other related standards include: <ul style="list-style-type: none"> • ANSI/AAMI RD62:2006, Water treatment equipment for hemodialysis applications and related therapies
Water Consumption Rate	470 ml/min, typical* *typical treatment conditions: dialysate flow rate 500 ml/min, concentrate ratio 1:44
Drain	3 feet maximum height. Must comply with local codes and must maintain a free fall air gap between drain hose and building drain. 3 meters (approximately 10 feet) maximum drain hose length.
Rinsing	Temperature 37 °C. Flow rate 620 ml/min. Time between 10 and 60 minutes (internally selectable)

Dialysate

Dialysate Quality Current national (U.S.) Standards for the Quality of Dialysis Fluid:

- ANSI/AAMI 11663:2014, Quality of dialysis fluid for hemodialysis and related therapies
- ANSI/AAMI 23500:2014, Guidance for the preparation and quality management of fluids for hemodialysis and related therapies

Other related standards include:

- ANSI/AAMI RD52:2004, Dialysate for hemodialysis

Dialysate Flow Adjustment Range

Dialysate Flow button

Accuracy: $\pm 5\%$

Dialysis: Sequential (0)/100*/150*/200*/300/400/500/600/700/800 ml/min., selectable on the "Home" screen; Additionally: 1.5X or 2.0X dialysate flow rate based on the Blood Pump rate (Qb):

<u>Qb w/1.5X selected</u>	<u>Qb w/2.0X selected</u>	<u>Qd</u>
0 – 165 [†]	0 – 150 [†]	300
166 – 215 [†]	151 – 215 [†]	400
216 – 315 [†]	216 – 265 [†]	500
315 and below [‡]	265 and below [‡]	500
316 – 415	266 – 315	600
416 – 480	316 – 365	700
481 and above	366 and above	800

Note: All flow rates are approximate. Dialysate flow will not adjust unless the blood pump is adjusted at least 15 – 20 ml/min.

SLED*: 100/150/200/300 ml/min

* Requires 'Allow Slow Flow' Service Mode option

[†] (if Auto Flow Minimum 300 Qd is set in Service Mode)

[‡] (if Auto Flow Minimum 500 Qd is set in Service Mode)

Concentrate Consumption Rate

30 ml/min (typical treatment conditions: dialysate flow rate of 500 ml/min, concentrate ratio of 1:44)

Partial Dialysate Collection

From Drain line, intermittent collection using a 3 Liter PD drain bag as a collection device with a Safe-Lock connector (optional).

Concentrate Supply

Concentrate Quality

Current national (U.S.) Standards for the Quality of Concentrates: ANSI/AAMI 13958:2014, Concentrates for hemodialysis and related therapies

Concentrate Pressure

Max suction height 3 feet; Max supplied pressure 2 psi

Note: Max supplied pressure is 10 psi with bibag kit installed.

Proportional Mixing System

Acid (functional software version 2.72 and later)

Volumetric, selectable:

1:44

Acid (functional software version 2.69 and earlier)	Volumetric, selectable: 1:34 1:35.83 1:35.1 1:44 Note: Citrasate is for use with 1:44 concentrates only.
Acetate (functional software version 2.69 and earlier)	1:34
Adjustment Range	130 to 155 mEq/L Na ⁺
Bicarbonate (functional software version 2.72 and later)	Volumetric, selected with associated acid ratio: 1:25.16
Bicarbonate (functional software version 2.69 and earlier)	Volumetric, selected with associated acid ratio: 1:27.46 1:19.13 1:25.16 1:27.6
Adjustment Range	20 to 40 mEq/L Bicarbonate (post-reaction, after mixing with the acid and purified water).
Monitoring Conductivity	Average Accuracy: $\pm 1.5\%$ Method: Temperature compensated electronic conductivity meter with adjustable alarm limits. Temperature compensated conductivity display with automatically set alarm windows ± 0.5 mS/cm around calculated conductivity*. User can adjust an additional ± 0.5 mS/cm within this range.
Optional bibag Dry Bicarbonate	Temperature compensated conductivity display with automatically set alarm windows ± 0.5 mS/cm around calculated conductivity*, limited to ± 0.4 mS/cm @ 24 mEq/L bicarbonate or less. With alarm window set at ± 0.5 mS/cm: User can move alarm window up or down an additional: ± 0.2 mS/cm @ 36 - 40 mEq/L ± 0.1 mS/cm @ 30 - 35 mEq/L no adjustment @ 20 - 29 mEq/L *Conductivity is based on the concentrates' compositional data entered in the "Dialysate" screen at the standard temperature of 25 °C.
Range of Display	10.0 to 17.0 mS/cm at 25 °C. Alarm limits will not go below 12.5 or above 16.0 mS/cm.
Dialysate Temperature Set Range	35 to 39 °C, selectable in 0.1 °C steps
Displayed Temperature Average Accuracy	± 0.3 °C

Appendix E

Alarm Limits	Alarm limit window automatically adjusts to 2 °C above and below set point. Alarm window will not go below 34 °C or above 41 °C. Note: During BTM bolus, temperature may drop no lower than 30 °C for a brief period of time.
Temperature Display	Range 35 to 39 °C with alarm limit window automatically adjusted to 2 °C above and below set point. Alarm window will not go below 30° or above 41 °C. Heater 1.3 kW, electronically controlled.

Heat Disinfection

Temperature	83 ± 8 °C at NTC 3
Flow Rate	600 ml/min Pre-rinse either 10 min @ 600 ml/min or 20 min @ 300 ml/min (user selectable).
Time	Between 10 and 60 minutes (internally selectable)
Auto Heat Disinfect Pre-rinse Time	Between 15 and 30 minutes (user selectable) @ 600 ml/min (standard) or 350 ml/min (extended pre-rinse). Note: Heater is off during pre-rinse.
Auto Heat Disinfect Pressure	25 psi < pressure < 90 psi Note: Silicon inlet/drain tubing set P/N 190679 must be used with this option.

Chemical Disinfection

Temperature	37 °C (set point applicable)
Flow Rate	620 ml/min
Time	Between 10 and 60 minutes (internally selectable)

Blood Pump

Display of flow rate	8 mm bloodline: 20 – 600 ml/min (not available with the Low Volume option set) 6.35 (displayed as 6.4) mm bloodline: 20 – 465 ml/min 4.8 mm bloodline: 10 – 274 ml/min 2.6 mm bloodline: 6 – 86 ml/min Accuracy: ± 10% tested at -200 mmHg
Internal diameter of pump segment	2.6 to 10 mm (0.1" to 0.4")
Tube length	32 cm minimum (12-5/8")
Min. pump segment wall thickness	1.26 mm
Durometer	80 shore A nominal
Level adjust	Up only
Power outage use	The pump can be manually operated with a hand crank.

Single Needle System

Two Pump Procedure With two blood pumps, pressure control system with alternating blood pumps. Alarm after 15 or 30 seconds without an alternation of the pumps.

Heparin Pump

Administration Rate 0 to 9.9 ml/hr
 Accuracy: $\pm 5\%$

Monitoring Monitoring end of stroke

Bolus From 0.1 to 9.9 ml volume

Type of Syringe The following disposable syringes have been validated for use on the machine heparin pump. The dimensions tested are provided by the syringe manufacturers and based on their specifications.

Machine Display	Vendor Syringe Name	Vendor Code
BD Black 10 ml	BD 10ml Syringe Only	301997
	BD 10ml Syringe Only	302995
	BD 10ml Syringe Only	300912
	BD 10ml Safety-Lok	305564
	BD 10ml Luer-Lok with Needle	309642
	BD 10ml Syringe & Needle Combo (WWD-Mexico)	309642-20
	BD 10ml Luer-Lok	309604
	10 mL BD Luer-Lok with 20 G x 1 in. needle	309644
Braun 10 ml	B. Braun 10ml Injekt Luer-Lock	4606728V-02
	B. Braun 10ml Luer-Lock	4617100V-02
Monoject 10 ml	Covidien/Kendall Monoject 12 ml Luer-Lock (re-labeled as 10 ml)	1181200777T
Monoject 12 ml	Covidien/Kendall Monoject 12 cc Luer Lock	1181200777
Nipro 10 ml	Nipro 10cc Luer-Lock without needle	JD+10L-WEI
	Nipro 10cc Luer-Lock	JD+10L2025-WEI
SOL-Care 10 ml	Sol-Care 10ml Luer-Lock Safety Syringe without Needle	120008IM
	SOL-M 10ml Luer Lock Syringe without Needle	180010
Terumo 10 ml	Terumo 10cc Luer Lock Tip Syringe without Needle	SS-10L
Jiangxi Sanxin 10 mL	Jiangxi Sanxin 10ml Disposable Syringe	C2-103L (G)-00

Monitoring Elements: Blood Circuit

Arterial Pressure Monitor	<p>Standard: -300 to +500 mmHg with 3 automatically set time-delayed alarm window limit values (± 60, ± 80, and ± 100 mmHg of actual pressure (Single Needle ± 80 mmHg).</p> <p>Low Volume: -260 to +100 mmHg (Pre Blood Pump) or -60 to +300 mmHg (Post Blood Pump) with 3 automatically set alarm limit window widths (± 40, ± 60, and ± 80) mmHg centered around set pressure. (Single Needle ± 80 mmHg).</p>
Venous Pressure Monitor	<p>Standard: -80 to +500 mmHg with 3 fixed window limit values of ± 60, ± 80, and ± 100 mmHg of actual pressure. There is also an asymmetric range initially set to ± 80 mmHg which increases the lower limit after 60 seconds (Single Needle ± 80 mmHg).</p> <p>Low Volume: -60 to +300 mmHg with 3 fixed window limit values of ± 40, ± 60, and ± 80 mmHg of set pressure. (Single Needle ± 80 mmHg).</p>
Accuracy	± 20 mmHg or $\pm 10\%$ of indicated reading, whichever is greater
TMP Monitor	+60 to -520 mmHg with automatically set time delayed window limit values of ± 60 (conventional dialysis) and ± 40 mmHg (high flux dialysis). Compensation for upward drift.
Level Detector	Ultrasonic impulses detect fluid level in the drip chamber.
Air Infusion Protection	<p>Maximum continuous air infusion rates to the patient before an alarm stops the blood pump:</p> <p>0.6 mL/min at blood flow rates up to 300 mL/min; 1.2 mL/min at blood flow rates from above 300mL/min to 500 mL/min; 1.8 mL/min at blood flow rates from above 500 mL/min to 600 mL/min.</p> <p>Maximum bolus air infusion rates to the patient before an alarm stops the blood pump:</p> <p>2 mL at blood flow rates up to 300 mL/min; 4 mL at blood flow rates from above 300mL/min to 500 mL/min; 6 mL at blood flow rates from above 500 mL/min to 600 mL/min.</p>
Optical Sensor	Optical transmission used to detect opaque or non-opaque presence in the blood tubing.
Clamp	Closes with any blood alarm
Level Adjust	Allows the level in the drip chamber to rise to maintain the desired fluid level in the drip chamber
Blood Pump speed and direction monitors	<p>Optical speed tachometer, Hall-effect direction sensor</p> <p>Alarm Limits: 30 second delay, maximum</p>
Blood Leak Detector	<p>Two color light source transmitter / sensor</p> <p>Resolution:</p> <p>minor ≥ 0.35 ml/min of blood (hematocrit = 25%) alarm ≥ 0.45 ml/min of blood (hematocrit = 25%)</p>

Ultrafiltration Control

UF Pump Volume Accuracy	$\pm 1\%$ (for $P_{di} > -500$ mbar) where P_{di} = dialysate pressure on the inlet side of the dialyzer
Fluid Removal Rate from Patient	0 – 4000 ml/hr Dialysate flow rate at 100 ml/min: Accuracy (on total volume removed): $\pm(1\%$ UF rate + 18 ml/hr) Dialysate flow rate at 500 ml/min: Accuracy (on total volume removed): $\pm(1\%$ UF rate + 30 ml/hr) Dialysate flow rate at 800 ml/min: Accuracy (on total volume removed): $\pm(1\%$ UF rate + 48 ml/hr)
Adjustment Range of UF Rate	Volumetric Control, adjusted in 10 ml/hr increments. Dialysis: 0-4000 ml/hr, SLED: 0-1000 ml/hr, Low Volume: 0-1000 ml/hr. Dialysis maximum rate (set in Service Mode): 1000, 2000, 3000, and 4000 ml/hr. Low Volume maximum rate (set in Service Mode): 500, 600, 700, 800, 900, and 1000 ml/hr
UF Time	Digital Display (0-9:59 hrs), selectable in increments of 1 min
UF Goal	Digital Display (0-9,990 ml), selectable in increments of 10 ml
UF Profiles	Eight UF profiles are available for the removal of fluid from the patient. Four are preset and four may be defined by the user.
Remaining Time of Dialysis (RTD)	0-9:59 hours auto transfer from UF time, counting down in 1-minute increments. Can adjust manually. Accuracy: ± 1 second per hour
UF Removed Display	Digital display max 9,999 ml counting in 1 ml increments.
Fluid Removal Rate Monitoring	Online Pressure Holding test for hydraulic leak detection Alarm Limit: 300 ml/hr minimum (DIASAFE _{plus} _{US} installed)
Additional Monitoring	Alarm in case of power failure. Alarm in case of water shortage.

Functional Options

Access Flow (Qa) (Optional, requires OLC)	Minimum Qa: Will not determine the Qa if less than the blood pump speed. Maximum Qa: 2000 ml/min
Auto Start	This optional feature automatically powers on the 2008T hemodialysis machine according to a schedule and begins running self-tests when concentrates are connected.
Assisted Reinfusion	This optional feature assists the operator in returning all of the patient's blood at the end of treatment.
Auto Heat Disinfect	Allows the user to program the 2008T hemodialysis machine to automatically run a heat disinfection program according to a schedule.

Appendix E

Auto Prime	This option aids the operator in automatically priming and testing the bloodlines.
bibag System	A hardware option to generate dialysate solution online from a dry bicarbonate powder. The bicarbonate powder is contained in a disposable bag called the <i>bibag</i> disposable which connects to the 2008T hemodialysis machine through the <i>bibag</i> connector.
Blood Temperature Monitor (BTM) (Optional)	A means of temperature control for the patient and for evaluating adequacy of access flow by measuring temperature changes in the arterial and venous lines after temporary excursions in the dialysate temperature.
Blood Volume Monitor (BVM) (Optional)	A module that measures the relative blood volume (hematocrit) as a means of determining if the fluid refilling rate from the body to the blood is insufficient to support the selected ultrafiltration rate. A fast rate of decrease or steeper slope in the blood volume trend graph may signal an upcoming hypotensive event.
CLiC (Optional)	A system that non-invasively measures hematocrit, oxygen saturation, and percent change in blood volume in real time and displays it on the “Crit-Line” screen (displayed instead of the “BTM BVM” screen). The Crit-Line in a Clip (CLiC) device plugs into the 2008T machine and clips onto a disposable cuvette in the bloodline in order to perform the measurement.
Default Rx (Parameters) Screen	An optional screen accessible by pressing the New Tx key when the Service Mode ‘Default Rx Screen’ option is set to ‘Yes’. Most treatment parameters can be conveniently set from this screen.
Diasafe Maintenance Reminder	An optional feature in the Service Mode “Scheduler” screen that can be used to set a DIASAFE <i>plus</i> _{US} filter replacement: when the maintenance due date is approaching, a message appears on the “Select Program” screen.
Disinfect Log	An optional screen that lists the last 1,200 heat and chemical/rinse disinfection events stored on the machine. The information can be transferred to a USB drive from this screen.
Independent Conductivity Self-Test	This option removes the need to independently verify the dialysate conductivity with an external meter. When a <i>bibag</i> disposable is the bicarbonate source, the external meter pH check is also no longer required.
Low Power Mode	An optional feature that turns off power to pumps, valves, and modules after a set amount of time the machine is idle on the “Select Program” screen.

Low Volume	<p>This option lowers blood pressure cuff ranges, pressure monitoring ranges, UF rates, and blood flow rates, and it restricts the allowable blood pump segment sizes to less than 8 mm for patients weighing between 20 and 40 kg.</p> <p>Note: The Low Volume option is not available with P/N 370085 (SunTech brand) blood pressure modules. Contact Fresenius Medical Care Technical Support for information on ordering compatible blood pressure modules.</p>
Online Clearance (Optional)	<p>Dialysate Flow rate: 300 – 800 ml/min</p> <p># of Tests: 1 – 6 during each treatment</p>
PatientCard	<p>Optional system that allows the operator to insert a patient information card into a slot on the IV Pole mount and download the patient's prescription, settings, and history of the last three treatments to the machine. The PatientCard reader can also write a name and ID number to a blank card and save changes to the prescription.</p>
PM (Preventive Maintenance) Reminder	<p>Optional feature that can be used to set a maintenance reminder at certain intervals, displayed on the "Select Program" screen.</p>
SLED (Sustained Low Efficiency Dialysis)	<p>A type of hemodialysis treatment that consists of lower dialysate and blood flow rates for up to 12 hours:</p> <p>Dialysate flow rates of 100, 150, 200 and 300 ml/min</p> <p>Ultrafiltration rates of 10-1000 ml/hr</p> <p>Blood flow rates of 0-300 ml/min</p>
Sodium Variation Profiles	<p>Three preset profiles (step, linear, and exponential) for increasing, then decreasing the sodium concentration in dialysate.</p>
Sodium Variation System (SVS)	<p>A means for temporarily increasing the sodium concentration at the beginning of dialysis for patient comfort.</p>
Software Hour Meter and Serial Number on Select Program Screen	<p>Optional feature that displays the Software Hour Meter and Serial Number on the "Select Program" screen</p>

User Interface

Language	<p>The operating screens may be set to either French (Canadian), Spanish (Mexico), or English (USA).</p>
Alarm Volume	<p>Range: 65-89 dBA (functional software versions 2.72 or later with 2008T BlueStar Premium)</p>

Blood Pressure Module

Technique	<p>Measures systolic, diastolic pressures, and heart rate (pulse rate) using oscillometric method. MAP measured.</p>
Cuff Deflation	<p>Interactive computer controlled. Determination for standard patients requires approximately 25-30 seconds depending on starting point, heart rate and motion artifact.</p>
Cuff Inflation	<p>Typically 5 - 10 seconds from 0-250 mmHg</p>

Essential Performance

Listed below are the essential performance characteristics of the 2008T BlueStar Hemodialysis Machine (functional software version 2.72 or later).

Feature	Specification																								
Blood Flow Rates	<table border="1" data-bbox="548 489 1312 785"> <thead> <tr> <th data-bbox="548 489 932 548">Bloodline</th> <th data-bbox="932 489 1312 548">Blood flow rate</th> </tr> </thead> <tbody> <tr> <td data-bbox="548 548 932 606">8 mm</td> <td data-bbox="932 548 1312 606">20-600 mL/min*</td> </tr> <tr> <td data-bbox="548 606 932 665">6.35 (displayed as 6.4) mm</td> <td data-bbox="932 606 1312 665">20-465 mL/min</td> </tr> <tr> <td data-bbox="548 665 932 724">4.8 mm</td> <td data-bbox="932 665 1312 724">10-274 mL/min</td> </tr> <tr> <td data-bbox="548 724 932 785">2.6 mm</td> <td data-bbox="932 724 1312 785">6-86 mL/min</td> </tr> </tbody> </table> <p data-bbox="548 800 1312 888">*Not available with the Low Volume feature enabled Accuracy: ± 10% tested at -200 mmHg</p>	Bloodline	Blood flow rate	8 mm	20-600 mL/min*	6.35 (displayed as 6.4) mm	20-465 mL/min	4.8 mm	10-274 mL/min	2.6 mm	6-86 mL/min														
Bloodline	Blood flow rate																								
8 mm	20-600 mL/min*																								
6.35 (displayed as 6.4) mm	20-465 mL/min																								
4.8 mm	10-274 mL/min																								
2.6 mm	6-86 mL/min																								
Dialysate Flow Rates	<p data-bbox="548 905 1442 972">Dialysate flow rates are selectable on the Home screen in the following mL/min increments:</p> <p data-bbox="548 993 1442 1031">(0)/100 †‡/150†‡/200†‡/300†/400/500/600/700/800</p> <p data-bbox="548 1052 1442 1089">† Sustained Low Efficiency Dialysis (SLED)</p> <p data-bbox="548 1110 1442 1178">‡ Flow rate requires that the Allow Slow Flow option be selected in Service mode.</p> <p data-bbox="548 1199 1442 1266">The dialysate flow rates (Qd) for both 1.5x or 2.0x dialysate flow (Auto Flow), based on the Blood Pump rate (Qb), are shown below.</p> <table border="1" data-bbox="548 1283 1300 1707"> <thead> <tr> <th data-bbox="548 1283 800 1341">Qb w/1.5x Qd</th> <th data-bbox="800 1283 1052 1341">Qb w/2.0x Qd</th> <th data-bbox="1052 1283 1300 1341">Qd</th> </tr> </thead> <tbody> <tr> <td data-bbox="548 1341 800 1379">0 – 165*</td> <td data-bbox="800 1341 1052 1379">0 – 150*</td> <td data-bbox="1052 1341 1300 1379">300</td> </tr> <tr> <td data-bbox="548 1379 800 1417">166 – 215*</td> <td data-bbox="800 1379 1052 1417">151 – 215*</td> <td data-bbox="1052 1379 1300 1417">400</td> </tr> <tr> <td data-bbox="548 1417 800 1455">216 – 315*</td> <td data-bbox="800 1417 1052 1455">216 – 265*</td> <td data-bbox="1052 1417 1300 1455">500</td> </tr> <tr> <td data-bbox="548 1455 800 1493">315 and below**</td> <td data-bbox="800 1455 1052 1493">265 and below**</td> <td data-bbox="1052 1455 1300 1493">500</td> </tr> <tr> <td data-bbox="548 1493 800 1530">316 – 415</td> <td data-bbox="800 1493 1052 1530">266 – 315</td> <td data-bbox="1052 1493 1300 1530">600</td> </tr> <tr> <td data-bbox="548 1530 800 1568">416 – 480</td> <td data-bbox="800 1530 1052 1568">316 – 365</td> <td data-bbox="1052 1530 1300 1568">700</td> </tr> <tr> <td data-bbox="548 1568 800 1606">481 and above</td> <td data-bbox="800 1568 1052 1606">366 and above</td> <td data-bbox="1052 1568 1300 1606">800</td> </tr> </tbody> </table> <p data-bbox="548 1728 1442 1795">Note: All flow rates are approximate. Dialysate flow will not adjust unless the blood pump is adjusted at least 15–20 mL/min.</p> <p data-bbox="548 1816 1442 1854">* If Auto Flow Minimum of 300 Qd is set in Service mode</p> <p data-bbox="548 1875 1442 1892">** If Auto Flow Minimum of 500 Qd is set in Service mode</p>	Qb w/1.5x Qd	Qb w/2.0x Qd	Qd	0 – 165*	0 – 150*	300	166 – 215*	151 – 215*	400	216 – 315*	216 – 265*	500	315 and below**	265 and below**	500	316 – 415	266 – 315	600	416 – 480	316 – 365	700	481 and above	366 and above	800
Qb w/1.5x Qd	Qb w/2.0x Qd	Qd																							
0 – 165*	0 – 150*	300																							
166 – 215*	151 – 215*	400																							
216 – 315*	216 – 265*	500																							
315 and below**	265 and below**	500																							
316 – 415	266 – 315	600																							
416 – 480	316 – 365	700																							
481 and above	366 and above	800																							

Feature	Specification							
Net Fluid Removal	0–4000 mL/hr							
	Dialysate flow rate	Accuracy (on total vol. removed)						
	100 mL/min	± (1% UF rate + 18 mL/hr)						
	500 mL/min	± (1% UF rate + 30 mL/hr)						
	800 mL/min	± (1% UF rate + 48 mL/hr)						
Dialysis Time	<table border="1"> <thead> <tr> <th data-bbox="537 569 870 615">Dialysis type</th> <th data-bbox="870 569 1443 615">Time</th> </tr> </thead> <tbody> <tr> <td data-bbox="537 615 870 674">Dialysis</td> <td data-bbox="870 615 1443 674">0-9:59 hours*</td> </tr> <tr> <td data-bbox="537 674 870 737">SLED</td> <td data-bbox="870 674 1443 737">Fixed at 12 hours</td> </tr> </tbody> </table>		Dialysis type	Time	Dialysis	0-9:59 hours*	SLED	Fixed at 12 hours
	Dialysis type	Time						
	Dialysis	0-9:59 hours*						
SLED	Fixed at 12 hours							
*Time can be adjusted manually								
Accuracy: ± 1 second per hour								
Dialysis Fluid Composition	<p>Volumetric, selectable:</p> <p>Acid adjustment range: 130–155 mEq/L Na⁺</p> <p>Bicarbonate adjustment range: 20–40 mEq/L Bicarbonate (post-reaction, after mixing with the acid and purified water).</p> <p>Monitoring conductivity average accuracy: ± 1.5%</p>							
Dialysis Fluid Temperature	Range 35°C–39°C with alarm limit window automatically adjusted to 2°C above and below set point. Alarm window will not adjust to below 34°C (or 30°C during BTM recirculation measurement) or above 41 °C.							
Heparin Delivery Rate	<p>0 – 9.9 mL/hr</p> <p>Accuracy: ± 5%</p>							

Manufacturer's EMC Declaration



Note: The EMISSIONS characteristics of this equipment make it suitable for use in industrial areas and hospitals (CISPR 11 class A). If it is used in a residential environment (for which CISPR 11 class B is normally required) this equipment might not offer adequate protection to radio-frequency communication services. The user might need to take mitigation measures, such as relocating or re-orienting the equipment.

Note: The 2008T Hemodialysis Machine has not been evaluated for use in locations using some EMI-emitting devices such as MRI and X-ray systems.

Guidance and manufacturer's declaration – electromagnetic emissions		
The 2008T hemodialysis machine is intended for use in the electromagnetic environment specified below. The customer or user of the 2008T hemodialysis machine should ensure it is used in such an environment.		
Emissions test	Compliance	Electromagnetic environment – guidance
RF Emissions CISPR 11	Group 1	The 2008T hemodialysis machine uses RF energy only for its internal functions. Therefore, its RF emissions are very low and are not likely to cause any interference in nearby electronic equipment.
RF Emissions CISPR 11	Class A	The 2008T hemodialysis machine is suitable for use in all establishments other than domestic and those directly connected to the public low-voltage power supply network that supplies buildings used for domestic purposes.
Harmonic emissions IEC 61000-3-2	Not applicable	
Voltage fluctuations/ flicker emissions IEC 61000-3-3	Not applicable	

Guidance and manufacturer's declaration – electromagnetic immunity			
The 2008T hemodialysis machine is intended for use in the electromagnetic environment specified below. The customer or the user of the 2008T hemodialysis machine should assure that it is used in such an environment.			
Immunity test	IEC 60601 test level	Compliance level	Electromagnetic environment – guidance
Electrostatic discharge (ESD) IEC 61000-4-2	±8 kV contact ±15 kV air (Level 4)	±8 kV contact ±15 kV air (Level 4)	Floors should be wood, concrete, or ceramic tile. If floors are covered with synthetic material, the relative humidity should be at least 30%.
Electrical fast transient/burst IEC 61000-4-4	±2 kV for power supply lines ±1 kV for input/output lines	±2 kV for power supply lines ±1 kV for input/output lines	Mains power quality should be that of a typical commercial and/or hospital environment.
Surge IEC 61000-4-5	±1 kV line(s) to line(s) ±2 kV line(s) to earth	±1 kV line(s) to line(s) ±2 kV line(s) to earth	Mains power quality should be that of a typical commercial or hospital environment.
Voltage Dips, short interruptions, and voltage variation on power supply input lines IEC 61000-4-11	<5 % U_T (>95 % dip in U_T) for 0.5 cycles 40 % U_T (60 % dip in U_T) for 30 cycles 70 % U_T (30 % dip in U_T) for 25 cycles 0 % U_T (100 % dip in U_T) for 5 seconds	<5 % U_T (>95 % dip in U_T) for 0.5 cycles 40 % U_T (60 % dip in U_T) for 30 cycles 70 % U_T (30 % dip in U_T) for 25 cycles 0 % U_T (100 % dip in U_T) for 5 seconds	Mains power quality should be that of a typical commercial or hospital environment. If the user of the 2008T hemodialysis machine requires continued operation during power mains interruptions, it is recommended that the 2008T hemodialysis machine be powered from an uninterruptible power supply or a battery.
Power-Frequency (50/60 Hz) magnetic field IEC 61000-4-8	30 A/m	30 A/m	Power frequency magnetic fields should be at levels characteristic of a typical location in a typical commercial or hospital environment.
NOTE U_T is the a.c. mains voltage prior to application of the test level.			

Guidance and manufacturer's declaration – electromagnetic immunity			
The 2008T hemodialysis machine is intended for use in the electromagnetic environment specified below. The customer or the user of the 2008T hemodialysis machine should assure that it is used in such an environment.			
Immunity test	IEC 60601 test level	Compliance level	Electromagnetic environment – guidance
Conducted RF IEC 61000-4-6	3 Vrms 150 kHz to 80 MHz	3 Vrms 150 kHz to 80 MHz	<p>Portable and mobile RF communications equipment should be used no closer to any part of the 2008T hemodialysis machine, including cables, than the recommended separation distance calculated from the equation applicable to the frequency of the transmitter.</p> <p>If abnormal performance is observed such as TMP alarms or blood leak alarms, additional measures may be necessary, such as re-orienting or relocating the equipment.</p> <p>Recommended separation distance</p> <p>$1.2 \sqrt{P}$</p>
Radiated RF IEC 61000-4-3	3 V/m 80 MHz to 2.7 GHz	3 V/m 80 MHz to 2.7 GHz	<p>$1.2 \sqrt{P}$ 80 MHz to 800 MHz</p> <p>$2.3 \sqrt{P}$ 800 MHz to 2.7 GHz</p> <p>where P is the maximum output power rating of the transmitter in watts (W) according to the transmitter manufacturer and d is the recommended separation distance in meters (m).</p> <p>Field strengths from fixed RF transmitters, as determined by an electromagnetic site survey,^a should be less than the compliance level in each frequency range.^b</p> <p>Interference may occur in the vicinity of High Frequency Surgical Equipment (such as electrocautery devices) or other intentional radio frequency emitting equipment typically marked with the following symbol:</p> 
NOTE 1 At 80 MHz and 800 MHz, the higher frequency range applies.			
NOTE 2 These guidelines may not apply in all situations. Electromagnetic propagation is affected by absorption and reflection from structures, objects, and people.			
^a Field strengths from fixed transmitters, such as base stations for radio (cellular/cordless) telephones and land mobile radios, amateur radio, AM and FM radio broadcast and TV broadcast cannot be predicted theoretically with accuracy. To assess the electromagnetic environment due to fixed RF transmitters, an electromagnetic site survey should be considered. If the measured field strength in the location in which the 2008T hemodialysis machine is used exceeds the applicable RF compliance level above, the 2008T hemodialysis machine should be observed to verify normal operation. If abnormal performance is observed, additional measures may be necessary, such as re-orienting or relocating the 2008T hemodialysis machine.			
^b Over the frequency range 150 kHz to 80 MHz, field strengths should be less than 3 V/m.			

Recommended separation distances between portable and mobile RF communications equipment and the 2008T hemodialysis machine			
The 2008T hemodialysis machine is intended for use in an electromagnetic environment in which radiated RF disturbances are controlled. The customer or the user of the 2008T hemodialysis machine can help prevent electromagnetic interference by maintaining a minimum distance between portable and mobile RF communications equipment (transmitters) and the 2008T hemodialysis machine as recommended below, according to the maximum output power of the communications equipment.			
Rated maximum output power of transmitter W	Separation distance according to frequency of transmitter m		
	150 kHz to 80 MHz $d = 1.2 \sqrt{P}$	80 MHz to 800 MHz $d = 1.2 \sqrt{P}$	800 MHz to 2.5 GHz $d = 2.3 \sqrt{P}$
0.01	0.12	0.12	0.23
0.1	0.38	0.38	0.73
1	1.2	1.2	2.3
10	3.8	3.8	7.3
100	12	12	23
For transmitters rated at a maximum output power not listed above, the recommended separation distance d in meters (m) can be estimated using the equation applicable to the frequency of the transmitter, where P is the maximum output power rating of the transmitter in watts (W) according to the transmitter manufacturer.			
NOTE 1 At 80 MHz and 800 MHz, the separation distance for the higher frequency range applies.			
NOTE 2 These guidelines may not apply in all situations. Electromagnetic propagation is affected by absorption and reflection from structures, objects, and people.			

CDX System Wifi Adapter

IEEE802.11ac/a/b/g/n dual band Adapter

Radio Frequency (RF): 2.412 GHz to 2.462 GHz, 5.18 GHz to 5.825 GHz

Power at 2.4 GHz: 32mW

Power at 5.0 GHz: 25mW

Modulation: Direct Sequence Spread Spectrum, Orthogonal Frequency Division Multiplexing

IEEE802.11b/g Adapter

Radio Frequency (RF): 2.412 GHz to 2.462 GHz

Power: 61mW

Modulation: Direct Sequence Spread Spectrum, Orthogonal Frequency Division Multiplexing

IEEE802.11a/b/g/n dual band Adapter

Radio Frequency (RF): 2.412 GHz to 2.462 GHz, 5.18 GHz to 5.825 GHz

Power: 279mW

Modulation: Direct Sequence Spread Spectrum, Orthogonal Frequency Division Multiplexing

Product Improvement Policy

The 2008T hemodialysis machine was designed and built to comply with these product specifications. It is the intention of Fresenius USA, Inc. to improve products continuously, a process which may result in modifications to specifications or equipment produced in the future. Such product improvements shall not incur any obligation to make similar changes or improvements to equipment previously produced. These changes or improvements may or may not be applicable or usable with previously produced equipment. Where possible, improvements will be made available at reasonable prices. Any such improvement shall not be construed as corrections of any perceived deficiency.

Warranty

SALE of the machine or parts described or referenced herein is expressly conditioned upon the terms and conditions set forth below. Any additional or different terms or conditions set forth by the Purchaser to Fresenius USA, Inc., (herein called "the Company") shall not be effective or binding, and the terms set forth herein shall not be modified or amended, unless assented to in writing by an authorized official of the Company located in Waltham, Massachusetts.

LIMITED WARRANTY: The Company warrants to the Purchaser that the equipment delivered is free from defects in material or workmanship for the periods specified below, provided the equipment is used and maintained in accordance with the original manufacturer's operating instructions:

A. Mainframe chassis, and electronic components, lamps, etc. shall be warranted for one hundred and eighty (180) days from the date of installation or 2,000 metered hours, whichever occurs first.

B. Consumables are not covered under warranty. Consumables are those parts used in the performance of a Preventive Maintenance procedure as described in the Preventive Maintenance Procedures booklet. This includes routine calibrations, electronic and hydraulic, as outlined in the Preventive Maintenance checklist.

The Company will repair or replace, at its option, using new or reconditioned parts and/or assemblies, any parts subject to this warranty, which are proven defective in materials or workmanship. Such repair and replacement will be made without cost to the Purchaser, and the Company reserves the right to determine the location at which the repair or replacement will be accomplished. The Warranty does not apply to any equipment which is misused, abused, neglected, tampered with, damaged by accident, flood, fire, or other hazard, subjected to abnormal or unusual electrical or fluid stress, improperly installed or operated, or not maintained in accordance with the routine maintenance schedule set forth in the operating manual for the equipment. **Routine maintenance is not covered under warranty.** Modifications, alterations, installation and service by other than a FRESINIUS USA, Inc. authorized representative may void the warranty.

WARRANTIES APPLICABLE TO EQUIPMENT EXTEND ONLY TO THE PURCHASER, AND ARE NOT ASSIGNABLE OR TRANSFERABLE, AND SHALL

NOT APPLY TO AUXILIARY EQUIPMENT, DISPOSABLE ACCESSORIES, OR LIGHT SOURCES. THE FOREGOING WARRANTY SHALL BE IN LIEU OF ANY OTHER WARRANTIES, EXPRESSED IMPLIED OR STATUTORY, RESPECTING THE EQUIPMENT OR ANY PARTS OR COMPONENTS THEREOF, AND THE COMPANY MAKES NO IMPLIED WARRANTY OF MERCHANTABILITY OR FITNESS FOR A PARTICULAR PURPOSE. THE PURCHASER'S SOLE AND EXCLUSIVE REMEDY IN CONTRACT, TORT, OR UNDER ANY OTHER THEORY AGAINST THE COMPANY RESPECTING THE EQUIPMENT AND ITS USE SHALL BE THE REPLACEMENT OR REPAIR OF THE EQUIPMENT AND ITS PARTS AS DESCRIBED ABOVE, AND NO OTHER REMEDY (INCLUDING, WITHOUT LIMITATION, CONSEQUENTIAL DAMAGES) SHALL BE AVAILABLE TO THE PURCHASER. The Company shall have no further obligation or liability with respect to the equipment or its sale, operation and use, and the Company neither assumes, nor authorizes the assumption of, any obligation or liability in connection with such equipment.

REFER ALL SERVICING AND INFORMATION REQUESTS TO:

Fresenius USA, Inc.

Attention: Service Department
4040 Nelson Avenue
Concord, CA 94520
Telephone: (800) 227-2572

Patents

Visit www.fmcna.com/patents for a listing of all applicable patents.

Glossary

Air Lock—A condition caused by air entering the concentrate supply lines when not enough liquid concentrate is available. Air lock causes dialysate conductivity to be low.

Alarm Window—The allowable range without alarm for the arterial, venous, and transmembrane pressures, and the dialysate temperature and conductivity during treatment. Transition of either value outside the window will trigger an alarm. The conductivity alarm window is graphically represented in the Dialysate screen as the area located between the upper and lower alarm limits of the conductivity bar graph. The alarm window can be widened or narrowed, or shifted up or down within the hard limits. The temperature alarm window is ± 2 °C of the set temperature value within the temperature hard limits (30 °C to 41 °C). The arterial and venous limit window width is also selectable. The position of the window is set automatically.

Assisted Reinfusion—An optional feature available on the “Test & Options” screen that assists the operator in returning all of the patient’s blood at the end of treatment.

Asymmetric Limits—This is an option to select venous limits that are not symmetrical. If asymmetric limits are chosen, the lower venous limit will tighten to the selected value after a short time delay. The lower venous limit choices are 20, 25, 30, 35 mmHg. The lowest value that does not cause frequent nuisance alarms should be chosen.

Auto Flow—A dialysate flow option in which the dialysate flow is proportional and linked to the blood flow rate. Auto Flow may be approximately either 1.5 times or 2 times the blood flow rate between 300 (or 500 depending on the setup in Service Mode) and 800 ml/min, in 100 ml/min increments. The dialysate flow rate on the “Home” screen is preceded by the letter ‘a’ when auto flow has been set.

Auto Start—An optional feature that automatically powers on the 2008T hemodialysis machine according to a schedule and begins running self-tests when concentrates are connected.

Auto Prime—An optional feature available on the “Test & Options” screen that aids the operator in automatically priming and testing the bloodlines.

Back Filtration—The movement of dialysate across the dialyzer membrane and into the patient’s blood. It can be caused by a change in pressure or concentration gradient between the dialysate and the blood.

Balancing Chambers—A hydraulic unit inside the 2008T hemodialysis machine consisting of two chambers that ensure that the amount of fresh dialysate entering the dialysate flow is equal to the amount of used dialysate being drained.

Base Na⁺—The prescribed base sodium level for the Final Dialysate, viewable in the SVS subscreen. The default Base Na⁺ value is carried over from the value entered in the Na⁺ button in the Dialysate screen. Changing the value in either button will change the value of the other.

Bell—Button located in the Dialogue Box that shows whether or not alarm is muted and can optionally be used to raise or lower the volume of alarms.

Bic—Abbreviation for “bicarbonate.”

Biofilm—Biological residue from treatment that collects on machine drain lines.

Blood Sensed—The venous line runs through an optical detector below the venous line clamp. When the line is opaque, the machine uses this “Blood Sensed” information for a number of alarm or informational messages or alarms.

BTM (Blood Temperature Monitor)—This is an optional module that can control or monitor the temperature and energy supply to the patient. It may be used to determine the recirculation of blood within the patient’s access.

Button—An area on the display screen that can be selected and will cause an action by the software.

BVM (Blood Volume Monitor)—This is an optional module that can measure the relative fraction of blood cells within the circulating fluid. It can be used to estimate how the machine’s ultrafiltration rate relates the fluid refilling rate from the extra-cellular compartments. If ultrafiltration rate is excessive compared to the refilling rate, a hypotensive event is more likely.

Bypass Mode—Bypass mode occurs when the dialysate goes outside alarm limits for temperature or conductivity. In bypass mode, valves inside the 2008T hemodialysis machine redirect the flow of dialysate to bypass the dialyzer internally until temperature and conductivity are back within acceptable limits. The 2008T hemodialysis machine can be manually put into bypass mode by lifting the shunt door.

Compliance Chamber—A blood-holding receptacle similar to a drip chamber. Compliance chambers are part of the arterial bloodline used in single-needle dialysis.

Conc—Abbreviation for “concentrate.”

CLiC Device—Abbreviation for “Crit-Line in a Clip.” See *Crit-Line in a Clip* for more information.

Crit-Line in a Clip—The Crit-Line in a Clip (CLiC) device is used to non-invasively measure a hemodialysis patient’s hematocrit, oxygen saturation and percent change in blood volume. These measurements occur in real time in order to provide a more effective treatment. The measurements are displayed on the 2008T hemodialysis machine’s “Crit-Line” screen. Under the direction of a physician, the clinician/nurse can increase or decrease the ultrafiltration (UF) rate in order to remove the maximum amount of fluid without the patient experiencing the common dialysis related complications which include hypotension, nausea, cramping and vomiting.

The system consists of software for the 2008T hemodialysis machine, a Crit-Line in a Clip (CLiC) device, a CLiC device-specific verification filter which is used to calibrate and verify the CLiC device, and a disposable Crit-Line Blood Chamber.

Default Parameters Screen—A screen accessible by pressing the **New Tx** key when the Service Mode ‘Default Rx Screen’ option is set to ‘Yes’. Most treatment parameters can be conveniently set from this screen.

Dialysate—Aqueous fluid containing electrolytes and usually buffer and glucose, which is intended to exchange solutes with blood during hemodialysis. This is the Final Dialysate, See *Final Dialysate* for more information.

Dialysis Mode—The machine software used to run either the Dialysis program or SLED program. Dialysis Mode can also include the “Select Program” screen where these therapy options are selected. CDX and Service Mode are not Dialysis Mode; however, while Dialysis Mode is displayed, the user can switch the display to CDX.

Diasafe Maintenance Reminder—An optional feature in the Service Mode “Scheduler” screen that can be used to set a DIASAFE_{plus}_{US} filter replacement: when the maintenance due date is approaching, a message appears on the “Select Program” screen.

DIASAFE_{plus}_{US} filter—A filter that is placed in the dialysate fluid path after the addition of the acid and bicarbonate concentrates, shortly before the dialysate is delivered to the dialyzer. It substantially reduces the level of bacteria and endotoxin (pyrogenic material) in the dialysate.

Disinfect Log—An optional screen that lists the last 1,200 heat and chemical/rinse disinfection events stored on the machine. The information can be transferred to a USB drive from this screen.

Dry Weight—The prescribed weight of a patient at which ultrafiltration has taken off the maximum amount of fluid.

eKt/V—Equilibrated Kt/V or double pool Kt/V. This accounts for rebound of urea after the treatment is stopped. The shorter the treatment time, the greater the percentage difference between spKt/V and eKt/V. We use the Tattersall formula to calculate eKt/V.

Fill Program—Occurs when water level in the air separation chamber gets too low. The air separation chamber is part of the hydraulic system inside the 2008T hemodialysis machine. This program is used to remove excessive air from the hydraulic system. The machine will normally go into a Fill program when the dialyzer is first connected to the dialyzer lines, and the air within the dialyzer is being purged. Repeated Fill programs during operation, however, could indicate a leak in the dialysate delivery system, and should be brought to the attention of a qualified technician.

Final Dialysate—The prescribed dialysate that is delivered to the dialyzer (patient) by the hemodialysis machine after the proportioning (mixing) of the acid concentrate, bicarbonate concentrate, and water. The final dialysate may also be referred to as the post-reaction dialysate (i.e. after proportioning (mixing) of the acid concentrate, bicarbonate concentrate and water by the dialysis machine).

Flow Indicator—A clear, cylindrical section of the dialyzer supply line that allows observation of the dialysate flow. When the dialysate flow is on, a small float inside the cylinder bobs up and down in rhythm to the dialysate pump. When the flow is off, the float sinks to the bottom of the cylinder.

Hard Limits—Unchangeable limits that are hard coded in the software and define the maximum and minimum, alarm-window values for the arterial, venous, and transmembrane pressures, and the dialysate temperature and conductivity. Hard limits are not apparent unless the user attempts to set a value outside the hard limit range.

Hemolysis—Rupture of red blood cells. This may be caused by hyponatremia (low blood sodium), dialysate that is too hot or too dilute (hypotonic), chloramines, copper, or nitrates in dialysate water, bleach in the dialysate, low dialysate conductivity, too-high arterial pressure or kinked blood tubing.

Idle Mode—When dialysis is first entered after a long power down, if a water alarm (temperature or conductivity) exists, the dialysate flow will be 800 ml/min until the machine is up to temperature and conductivity. The dialysate flow then drops to 300 ml/min while the machine is “idle”. The machine will also enter Idle Mode after a treatment is finished (RTD = 0, blood not sensed, and Blood Pump stopped, and the dialysate flow rate > 300 ml/min). This mode is terminated when treatment is started (RTD > 0 or blood sensed by the optical detector) or the dialysate flow rate is changed manually.

Isolated UF—A treatment option in which the ultrafiltration pump draws excess fluid off the patient while the dialysate flow is turned off. See also Sequential Dialysis.

Kecn—Effective Clearance as determined with conductivity measurements. The calculated clearance based on the change in conductivity of the pre-dialyzer versus post dialyzer dialysate. Kecn appears in OLC Data subscreen of the “Kt/V AF” screen.

Keys—Are located on the control panel, outside the display screen. Keys are used to enter numbers, confirm selections on the display screen, and activate certain functions.

KoA—Overall mass transfer coefficient multiplied by surface area of a dialyzer.

Kt/V—A measure of therapy delivered to the patient. (K = clearance rate, t = time, V = urea distribution volume). The Kt/V value shown are Single Pool Values (spKt/V). The OLC system is used to determine the effective dialyzer clearance used for this determination.

KUF—An ultrafiltration coefficient that describes how permeable a dialyzer is to water. It is a direct function of surface area and is defined as the number of millimeters of fluid per hour that are transferred across the membrane per mmHg TMP.

Long Power Down—The act of turning off the machine for longer than one minute. Certain information stored in memory is lost after one minute, and some treatment parameters are reset to their default settings. Power failures are not the same as long power downs, and treatment data are saved when power to the machine is interrupted in such instances. (See *Short Power Down* and *Power Failure Recovery*)

Low Power Mode—Option set on the Service Mode “Scheduler” screen that turns off power to pumps, valves, and modules after a set amount of time the machine is idle on the “Select Program” screen. During this time the Status Light will flash green and the digital hour meter will not increment. Touching the keyboard, touchpad, or touchscreen will ‘wake up’ the machine.

Low Volume—Option set on the “Test & Options” screen that limits blood pump bloodline segments to less than 6.4 mm and reduces arterial and venous pressure limits, ultrafiltration rates, and blood pressure monitor ranges. This option is to be used for patients weighing between 20 kg (44 lbs.) and 40 kg (88 lbs.).

Numeric KoA—See *KoA*.

OLC (Online Clearance)—This is an optional system that can determine the effective conductive clearance of a dialyzer up to six times during dialysis.

Override—All protective systems are in operation during treatment. During a blood leak alarm, the user has the option to temporarily suspend (override) a protective system by pressing and holding the **Reset** key for three seconds. During a blood leak override, the machine’s blood leak monitor is inactive for three minutes. The Status Box will indicate a blood leak override is in effect.

PatientCard—Part of an optional system that allows the operator to insert a patient information card into a slot on the IV Pole mount and download the patient’s prescription, settings, and history of the last three treatments to the machine. The PatientCard reader can also write a name and ID number to a blank card and save changes to the prescription.

Pillow—Small blood reservoir on the Single Needle bloodline. It is located before the first blood pump segment.

PM Reminder—Abbreviation for Preventive Maintenance Reminder, an optional feature in the Service Mode “Scheduler” screen that can be used to set a maintenance reminder at certain intervals, displayed on the “Select Program” screen. When the maintenance due date is approaching, an additional message appears on the “Select Program” screen.

Positive Pressure—Condition that exists when air or fluid pressure inside the dialysate lines is greater than outside of the lines. If an opening occurs, air or fluid will flow out of the system.

Post-Reaction Bicarbonate—The prescribed Final Dialysate bicarbonate that will be delivered to the dialyzer in the Final Dialysate after the proportioning (mixing) of the acid concentrate, bicarbonate concentrate, and water. The post-reaction bicarbonate value is entered on the “Dialysate” screen in the **Bicarbonate** button.

Power Failure Recovery—When power to the machine is lost, many dialysis parameters are stored and recovered when the power is restored to the machine.

Prescription Screen—An optional screen accessible by inserting a PatientCard into the optional PatientCard Reader. Most treatment parameters can be conveniently set from this screen.

Pressure Holding Test (PHT)—There are different Pressure Holding Tests. A PHT verifies the integrity of the hydraulic system, which is necessary for accurate fluid balance and UF control. An extensive Pressure Holding Test is performed in the Pressure Test self-test on the “Test & Options” screen. An Online Pressure Holding Test is done every 12 minutes during treatment. It lasts about seven seconds, depending on the dialysate flow rate (two cycles of the balancing chamber). The online PHT must be selected in Service Mode and the ‘Online PHT’ option is mandatory (set to ‘Yes’ and grayed-out) when the *bi*bag module is installed.

Reverse Osmosis (RO)—A method for purifying water by forcing it through a semipermeable membrane that prevents the passing of mineral ions.

RTD—Remaining Time on Dialysis. The amount of time remaining until the end of the treatment. RTD is viewable in the Home screen.

Scheduler Screen—A Service Mode screen that contains the optional Low Power Mode setting and allows access to Auto Heat Disinfect and the optional Auto Start program, CDX Auto On, PM Reminder, and Diasafe Maintenance screens (functional software version 2.72 or later)

Screen Access Button—Any of the eight blue buttons located in the row along the bottom of the display screen. Selecting one of these buttons will bring up the corresponding treatment screen on the display screen.

Sequential Dialysis—A two-stage form of dialysis treatment in which the first stage consists exclusively of ultrafiltration. In the first stage, there is no dialysate flow while the ultrafiltration pump draws excess fluid off the patient. After the determined amount of fluid has been drawn, the second stage, usually a standard dialysis treatment, occurs. See also *Isolated UF*.

Service Mode—A functional state of the 2008T hemodialysis machine that allows technicians to calibrate the machine or program various software features and options that are only accessible in Service Mode.

Short Power Down—Refers to the act of turning off the power with the Front Panel **Power** key to the machine for less than one minute before powering back on to the “Select Program” screen. During a short power down, self-test results are cleared and the acid/bicarb alert is set to 'off'; all treatment, rinse, and alarm settings and data are saved. However, after one minute they will be erased. See also *Long Power Down* and *Power Failure Recovery*.

Single Needle Dialysis—This is a system with the use of two blood pumps to allow blood access to the patient with a single needle. The pumps alternately turn on and off to pull fluid from the patient and then return the dialyzed blood with minimal recirculation.

SLED—Abbreviation for Sustained Low Efficiency Dialysis, a type of hemodialysis treatment that consists of lower dialysate and blood flow rates for up to 12 hours.

Sodium Variation System (SVS)—A program that varies the concentration of sodium in the dialysate during treatment. Increased sodium at the onset of treatment is sometimes prescribed to prevent cramping in the patient. Increasing sodium results in increased levels of other electrolytic constituents and a higher level of conductivity.

Standard—The type of dialysis selected with the **Dialysis** button from the “Select Program,” screen; a standard patient weighs more than 40 kg.

SVS Profile—A programmable feature for varying the level of sodium in the dialysate throughout the course of treatment.

SVS Time—Time length in hours and minutes prescribed for SVS program.

Theoretical Conductivity (TCD)—The expected conductivity of the dialysate based upon the concentrate type, and sodium and bicarbonate values entered in the Dialysate screen. TCD is measured in milliSiemens per centimeter (mS/cm) and is corrected to 25 °C.

Transducer—An electronic device inside the 2008T hemodialysis machine that reads the pressure inside the arterial and venous drip chambers. The drip chamber and transducer are connected via a thin tube that is part of the extracorporeal blood circuit.

Transducer Protector (TP)—A small, disposable, plastic connector containing a hydrophobic, paper filter that fits over each pressure port. It is inserted between the pressure monitor line and the pressure port connection and is used to prevent the transducer from becoming wet or contaminated with blood. There are two transducer protectors for each connection, a disposable external TP that is to be replaced with each treatment. A second internal TP is also installed.

Ultrafiltration (UF)—Ultrafiltration is the process of drawing off excess fluid from the patient during treatment. The 2008T hydraulic system is a closed system that uses a separate UF pump for greater accuracy.

Index

	#	
# of Tests button.....		149
	9	
9-Volt Battery		
Alarm		169
Replacing		279
	A	
Access Flow		147, 151, 371
Acid		
Connector		46
Type Setting		89
Types.....		314
Acid & Heat Disin program.....		183, 195
Acid Clean program.....		190, 195
Acid/Bicarb Alert default option		330
Acid/Bicarbonate Alert		85
setting.....		91
Actual Conductivity		83, 92, 107
Actual Time data box.....		153
Adding New Concentrates		334
Additional Volume, Default Prescription screen		125
Additional Volume, Prescription screen		134
Air lock		55
Air Lock.....		383
Alarm		
Position button		85
Position button locked.....		85
Types.....		201
Width button		85
Window.....		92, 383
Alarm Limits option.....		320
Alarm Sounds.....		199, 342
Alarm Volume		31, 36, 199
Alarm Volume Locked		31
Alarm Volume, locking		342
Alarms.....		199
Allow Slow Flow		318
Apps		54
Arrow		<i>See</i> Cursor
Arterial Chamber option		322
Arterial Drip Chamber Module.....		39
Arterial pressure monitoring.....		141
Arterial Width button.....		115
Assisted Reinfuion		
Definition		383
Assisted Reinfusion		174
Assisted Reinfusion button		115
Assisted Reinfusion option		320
Asymmetric Limits		383
Asymmetric Venous Limits option...		321
Audible Alarms Disabled option		323
Auto Flow		96, 140, 366, 383
Selection button		318
Auto Flow Minimum		318
Auto Heat Disinfect		329, 347
Auto Heat Disinfect option		
Version 2.69 or earlier		332
Version 2.69 or later		345
Auto Prime		67
Definition		383
Auto Prime button.....		115
Auto Prime Final Setup.....		72
Auto Prime option.....		320
Auto Prime Testing.....		67
Auto Start		
Complete.....		60
Definition		383
Method		58
Option setting.....		347
	B	
Back Filtration		383
Balancing Chambers		383
Base Na ⁺		383
Base Na ⁺ button		84, 105
Beacon option		323

- Bell button..... 31, 199
 - Bell Button definition 383
 - bi**bag**
 - Changing..... 167
 - Cleaning 187
 - Connecting 55, 59
 - Connector 46
 - Disposable..... 46, 48
 - Disposable run time 315
 - Door 48
 - Emptying..... 85, 178
 - Option 371
 - Specifications..... 367
 - Switching to liquid bicarbonate 138
 - Bic..... *See* Bicarbonate
 - Bicarbonate
 - Alert *See* Acid/Bicarbonate Alert
 - Alert Setting 91
 - Connection 56
 - Connector 46
 - Type Setting 89
 - Types..... 314
 - Biofilm 384
 - Birthdate..... 127
 - Blood Alarms 201
 - Blood Pressure 15, 117, 318, 373
 - Cuff..... 44
 - Graph..... 117, 163, 165
 - Module 44
 - Test..... 165
 - Test, unscheduled..... 165
 - Blood Pressure Cuff, fitting 136
 - Blood pump
 - hand crank..... 169
 - preparing for treatment ... 62, 283, 290
 - Blood pump module..... 40
 - description..... 40
 - illustration 41
 - Blood Pump Rate button40, 97, 141, 296
 - Blood Recirculation 168, 292
 - Blood Sensed 225, 252, 384
 - Blood Temperature Monitor Screen155, *See also* BTM
 - Blood Tubing 44, *See* Bloodlines
 - Blood Volume Change graph..... 162
 - Blood Volume Monitor Screen155, *See also* BVM
 - Blood Volume Processed
 - data box..... 149, 153
 - data box in SLED..... 296
 - Bloodlines ... 44, *See also* Extracorporeal Circuit
 - Priming..... 64
 - Priming (Single Needle) 285
 - Removing..... 180
 - Setup 61
 - Blue key 34
 - Bolus button 109
 - BP..... *See* Blood Pressure
 - BP Cuff, fitting..... 136
 - Bracket 25
 - BTM..... 155, 371, 384
 - BTM option..... 342
 - Button..... 384
 - Button Types..... 32
 - BV *See* Blood Volume
 - BVM 155, 371, 384
 - BVM option 342
 - Bypass mode 49, 384
- ## C
- Calculated UF Goal, Default Parameters screen 125
 - Calculated UF Goal, Default Prescription screen 125
 - Calculated UF Goal, Prescription screen134
 - CDX
 - Key 34, 298, 300
 - Mode 298
 - Restart system 301
 - Speaker..... 36
 - USB port 36
 - CDX Auto On 303
 - CDX Auto On option setting 349
 - Central Venous Catheter 22
 - Chemical/Dwell program..... 194
 - Chemical/Rinse program 192
 - Citrasate 86, 337
 - Citrate..... 339
 - Cleaning and Disinfection..... 181
 - CLiC device158, 372, 384, *See also* Crit-Line

- Clipping to bloodline 136
 - Manually verifying..... 114
 - Removal 180
 - Clock..... 119, 318
 - Clock Time (BP)..... 119
 - Compliance Chamber..... 384
 - Conc *See* Concentrate
 - Conc button..... 84
 - Concentrate Connectors 46
 - Concentrate Containers
 - Connector caps..... 46
 - Disinfecting..... 187
 - Treatment Setup 55
 - Concentrates 313, *See also* Acid/Bicarbonate
 - Types
 - Cond Alarm Position option 321
 - Conductivity
 - Actual..... 92
 - Button..... 97
 - Limits 92
 - Monitoring 140
 - Testing..... 362
 - Testing, automatic..... 67, 72, 73
 - Theoretical 92, 107, 388
 - Conductivity Alarm Position option . 321
 - Confirm key, description 35
 - Control Panel 27
 - Crank..... *See* Blood pump, hand crank
 - Crit-Line..... 384
 - Blood Chamber, connecting..... 63
 - Clipping to bloodline 136
 - Graph selection option 342
 - Manually verifying..... 114
 - Screen..... 33, 139
 - Current Weight, Default Parameters screen
 - 124, 125
 - Current Weight, Prescription screen 133, 134
 - Cursor..... 35, 80
 - Custom UF Profiles..... 340
- D**
- Default Dial Flow 319
 - Default Parameters..... 120
 - Default Parameters Screen definition 372, 384
 - Default Rx Screen 80, 120
 - Default Rx Screen option..... 329
 - Delivered Kt data box 154
 - Delivered Kt/V
 - Equilibrated data box 154
 - Single-pool data box 154
 - Dialogue Box 31, 200
 - Dialysate 384
 - Dialysate Alarms..... 203
 - Dialysate Flow button..... 84, 96
 - Dialysate Flow button, monitoring ... 140
 - Dialysate path..... 45, 312
 - Dialysate Sample Port..... 361
 - Dialysate Sampling option..... 324
 - Dialysate Screen
 - settings 83
 - Dialyzer
 - Holder 51
 - Requirements 48
 - Dialyzer Time meter box 296
 - Dialyzer, emptying..... 179
 - Dialyzer, removing 179
 - Diasafe Auto-Test option..... 322
 - Diasafe Maintenance Reminder definition
 - 385
 - Diasafe Plus Filter Maintenance Due 355
 - DIASAFE *plus*_{US} Filter..... 385
 - Replacing 278
 - Testing..... 114, 193, 278
 - Diasafe Reminder
 - Resetting 354
 - Setting..... 354
 - Disinfect Log 182, 198
 - Disinfect Log definition..... 385
 - Disinfectant, testing for..... 197, 362
 - Disinfection Log 198
 - Dry Weight definition..... 385
 - Dry Weight, Default Prescription screen 125
 - Dry Weight, Prescription screen 134
- E**
- eKt/V..... 385
 - Electrolyte profile 107
 - Electromagnetic
 - Emissions 377
 - Environment..... 377
 - Immunity..... 377
 - Empty bibag button..... 85, 178
 - Enable OLC button 148

Escape Key
 Keyboard..... 34
 Touchpad..... 35
 Ethernet Port 36, 301
 Exp button *See* Exponential Profile (SVS)
 button
 Exponential Profile (SVS) button 105
 Extended Lines Bracket 25
 Extracorporeal Circuit.... 24, 61, *See also*
 Bloodlines

F

Fill Program 385
 Final Dialysate 86, 385
 Flow Indicator..... 385
 Fluid Sample Port 46
 Fn Lock key 34
 Forced Test..... 317

G

GranuFlo 86, 337
 Green button
 Heparin..... 112, 138
 SVS Profile 106, 138

H

Hard Limits 385
 Hardware key 360
 Hct..... *See* Hematocrit
 HE Leak Test option 323
 Heat Disinfect program.... 191, 195, 347
 Heat Exchanger Leak Test option.... 323
 Heater switch 36
 Hematocrit graph 162
 Hemolysis 385
 Heparin Bolus 109
 Heparin Delivery system, preparing . 110
 Heparin Dwell..... 109, 318
 Heparin Prime button..... 109
 Heparin pump..... 42
 Heparin Rate button 109
 Heparin Rate button in SLED..... 296
 Heparin screen
 setting parameters in 108
 High Alarm Status..... 201
 High Flux button..... 115
 Home screen

monitoring the treatment..... 139
 Hour Meter..... 36

I

Idle Mode 319, 385
 Independent Conductivity
 bibag testing..... 46
 Self-test 73
 Service Mode option..... 324
 Inflation Pressure button..... 119
 Infuse Bolus button..... 109
 Infusion Time button..... 109
 Interval button..... 119
 Isolated UF..... *See* Sequential Dialysis
 Isolated UF definition 385
 IV Pole 25, 51

J

Jugs *See* Concentrate Containers

K

Kecn 386
 in OLC table..... 154
 Keyboard..... 34
 Keys 386
 KoA..... 386
 Kt/V..... 386
 Kt/V Calculator button..... 148
 Kt/V Default..... 320
 Kt/V graph 149
 Kt/V screen 147
 KUF..... 143, 386

L

Language..... 320
 Last Disinfection..... 182
 Last Reset data box 296
 Level Adjust key 40, 41
 Level Detector Adjust key 44
 Level Detector module..... 43
 Light..... *See* Status Light
 Lin button *See* Linear Profile (SVS) button
 Linear Profile (SVS) button 105
 Load Syringe button..... 109
 Lock Alarm Volume 342
 Long Power Down 386
 Low Alarm Status 200

Low Power Mode..... 28, 30, 54
 Definition 386
 Low Power Mode, setting 343
 Low Volume
 description..... 372
 Low Volume button 114
 Low Volume definition..... 386
 Low Volume Dialysis 116
 Low Volume Maximum UF Rate option331
 Lower Dia button 118
 Lower Pulse button 118
 Lower Sys button 118

M

Machine
 Lock-up or unresponsive..... 204
 Machine Specifications 364
 Mains Power Supply switch..... 36
 Manual OLC Test button 148
 Manually turning the blood pump..... 170
 MAP*See* Mean Arterial Pressure
 Maximum UF Rate 100, 102
 Maximum UF Rate option 331
 Mean Arterial Pressure 165
 Medical Information System..... 128, 303
 MIS*See* Medical Information System
 Moving the machine 51
 Mute key 202
 Description 28
 Muted Alarm..... 28, 202

N

NaturaLyte 86, 337
 New Concentrates, adding 334
 New Concentrates, selecting 334
 New Patient Information..... 127
 New Treatment key..... 80
 New Treatment Prescription Warning330
 New Tx key120, *See* New Treatment key
 Description..... 29
 New Tx Rx Warning..... 80, 330
 No Power alarm 37
 None (SVS) button..... 105
 Normal Status..... 200

O

O₂ Sat*See* Oxygen Saturation

Off after Heat Disin option 328, 346
 OLC..... *See* Online Clearance
 OLC Data button..... 148
 OLC Data screen..... 153
 OLC option 324
 Online Clearance..... 147, 386
 Online PHT*See* Online Pressure Holding
 Test
 Online PHT option 322
 Online Pressure Holding Test76, 166, 387
 Optical Detector 44
 Override 386
 Oxygen Saturation graph 162

P

P art.
See Pressure port, arterial..... 41
 P ven..... *See* Pressure port, venous
 Patient Birthdate..... 127
 Patient ID 127, 129
 Patient ID button 114
 Patient Information, verifying..... 128
 Patient Name..... 127
 PatientCard definition 386
 PatientCard option 341
 PatientCard Reader 25, 38
 PatientCard, blank..... 127
 PatientCard, new 127
 PatientCard, view previous treatments144
 pH Testing..... 362
 pH, automatic testing with bibag .. 67, 72
 PHT *See* Pressure Holding Test
 Pillow 386
 Plasma Na⁺ 318
 Plasma Na⁺ data box 153
 PM Due Within 352
 PM Reminder
 Additional Message 352
 Due Within..... 352
 Resetting 351
 Setting 351
 PM Reminder definition 386
 Positive Pressure 387
 Post-pump arterial chamber 61
 Post-Reaction Bicarbonate..... 387
 Power Failure 169, 292
 during chemical disinfection..... 197

resumption procedure..... 171
 Power Failure Recovery..... 387
 Power key
 Description..... 28
 Prescription screen..... 129
 Prescription Screen definition..... 387
 Pressure and Alarm tests..... 73, 287, 289
 Pressure Holding Test..... 387
 Pressure port
 Arterial 41
 Venous 44
 Preventive Maintenance Reminder*See* PM
 Reminder
 Prime Amount..... 65, 286
 Prime Amount option..... 330
 Prime key
 Description..... 29
 Pump segment..... 44

R

Rate button*See* Heparin Rate
 Recirc option..... 330
 Recirculation.... *See* Blood Recirculation
 Recirculation (non-Auto Prime) 76
 Reset key
 Description..... 29
 Returning Blood
 Emergency 169
 Returning Blood
 Assisted Reinfusion 174
 Standard Method..... 173
 Reverse Osmosis..... 387
 Rinse program..... 189
 RO... *See* Reverse Osmosis, *See* Reverse
 Osmosis
 RS 232 Port..... 36
 RTD..... 387
 in Kt/V graph 149
 RTD = 0 172, 292
 RTD button 97
 monitoring..... 140

S

Screen Access Button 387
 Select Program screen..... 54, 181
 Selecting New Concentrates 334
 SEQ.....*See* Sequential Dialysis

Sequential Dialysis..... 102, 387
 Service mode..... 387
 Service Mode 54, 316
 Short Power Down..... 387
 Shunt Interlock..... 26, 49
 Single Needle 61, 368
 Single Needle button..... 115
 Single Needle Dialysis..... 281
 SLED..... 294
 Description..... 372
 SLED definition 388
 Sodium Variation System 104, 388
 Speaker
 CDX 36
 Dialysis Mode 36
 Spread Limits 317
 Standard Prime..... 64, 285
 Start Na⁺ button..... 105
 Start/Stop key (blood pump)..... 41
 Stat/Deflate key..... 165
 Description..... 29
 Status Box 30, 199
 Status Light 30, 323
 Flashing..... 109
 Step Profile (SVS) button 105
 Storage and maintenance 363
 Storage Preparation..... 363
 Subtract Weight, Default Parameters screen
 125
 Subtract Weight, Prescription screen 134
 Sustained Low Efficiency Dialysis....*See*
 SLED
 SVS *See* Sodium Variation System
 SVS on/off option 319
 SVS Profile 388
 Button..... 85, 97
 Setting..... 106
 SVS Time..... 388
 SVS Time button..... 105
 Switches
 Heater 36
 Power 36
 Syringe button..... 109

T

Tare Weight*See* Subtract Weight
 Target Kt/V 148, 318, 323

data box 154
 less than 85 percent 150
 TCD.....*See* Conductivity, Theoretical
 Temperature button 97
 Temperature button, monitoring 140
 Test & Options screen
 Setting treatment parameters 113
 Testing.....*See* Pressure and Alarm Tests
 Theoretical Conductivity *See* Conductivity,
 Theoretical
 Time 119
 Timer *See* Heparin Dwell
 TMP *See* Transmembrane Pressure
 Toggle-Buttons, using 82
 Total Infused button 109
 Touchpad 35
 Transducer 388
 Transducer Protector 62, 283, 388
 Transmembrane pressure
 monitoring 143
 Treatment Clock button 97
 Treatment Parameters
 entering 81
 Treatment Summary 33, 144
 Trends screen 144
 Troubleshooting 203
 Tx Clock button 140

U

UF Goal button 95
 UF Goal Reached 172, 292
 UF on/off key 98
 Description 29

UF Profile 99
 UF Profile button 97
 UF Profiles, custom 340
 UF Rate button 96
 UF Rate button, monitoring 139
 UF Removed button 96
 UF Removed button, monitoring 140
 UF Time button 95
 UF Time button, monitoring 139
 Ultrafiltration 45, 99, 388
 Ultrafiltration coefficient 143, *See also* KUF
 Upper Dia button 118
 Upper Pulse button 118
 Upper Sys button 118
 USB Port 26, 301
 USB Port 1 198, 302
 USB Port 2 302

V

Venous Limits option 321
 Venous Line Clamp 43, 44
 Venous pressure
 monitoring 142
 Venous Width button 115
 Verify Crit-Line button 114
 Volume (OLC)
 Button 148
 Data box 153
 Volume (sound pressure level) 36

W

Water Supply maintenance 188
 Wheel Lock 51